

Discharge systems for pellets

RS4 / RS8 PELLET SUCTION SYSTEM
4 PROBE MANUAL SUCTION SYSTEM
SUCTION SCREW
1-2-3 SUCTION SCREW SYSTEM
BAG SILO
CUBE
PELLET BOX
PELLET MOLE



BETTER HEATING

INNOVATIVE AND
COMFORTABLE

froling 

GUARANTEED QUALITY AND RELIABILITY FROM AUSTRIA

For almost sixty years Froling has specialised in the efficient use of wood as a source of energy. Today the name Froling stands for modern biomass heating technology. Our firewood, wood chip and pellet boilers are successfully in operation all over Europe. All of our products are manufactured in our factories in Austria and Germany. Froling's extensive service network ensures that we can handle all enquiries quickly.

- Excellent environmental compatibility
- Environmentally responsible energy efficiency
- Ideal for all types of house
- More convenience for you
- Sophisticated fully automatic operation
- International pioneer in technology and design



Make savings with pellets without compromising on comfort

The price changes for different energy sources in recent years show the benefits of wood pellets: the environmentally clean way of heating is also economically attractive. Wood is a renewable energy source that is also CO₂-neutral. Pellets are made of natural wood. The large quantity of wood shavings and sawdust produced by the industry are compacted and pelleted without being treated beforehand. Pellets have a high energy output and are easy to deliver and store. These are just some of the advantages that make pellets the perfect fuel for fully automatic heating systems. Pellets are delivered by tanker and unloaded directly into your store.

OPTIMAL SOLUTIONS



4 probe manual suction system



Pellet Mole®

RS 4 / RS 8 pellet suction system

Fully automatic back flushing



Cube 330 / 500 S

Bag silo discharge system

Available in 8 sizes



Pellet box

Suction screw system

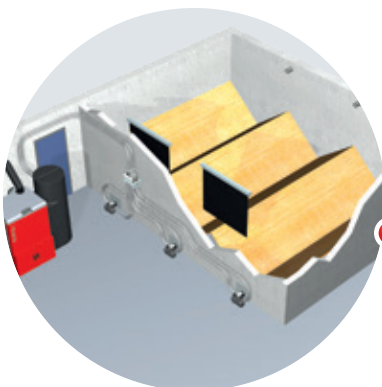

1-2-3 suction screw system

Triple RS 4 / RS 8 pellet suction system

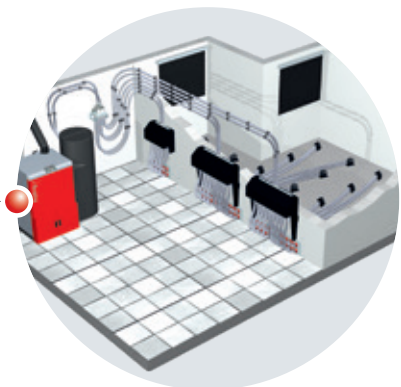

GENERAL NOTES ON STORE DESIGN

The ideal storeroom should provide enough space for a year's supply of pellets, be dry and preferably situated at an outer wall (for fitting inlet nozzles). In the case of a brick store which can be fitted either with the Froling suction or screw suction system, please make sure that the walls can support the static loads.

A sloping floor (made of wood) is recommended for optimal emptying of the storeroom, but is not essential. The storeroom must allow for an air supply to regulate the CO concentration. If the filling pipe is installed indoors, the coupling cap must be air-tight with separate ventilation to outside. If the filling pipe leads outside, the Froling coupling cap is vented.

TECHNICAL EQUIPMENT IN THE STOREROOM

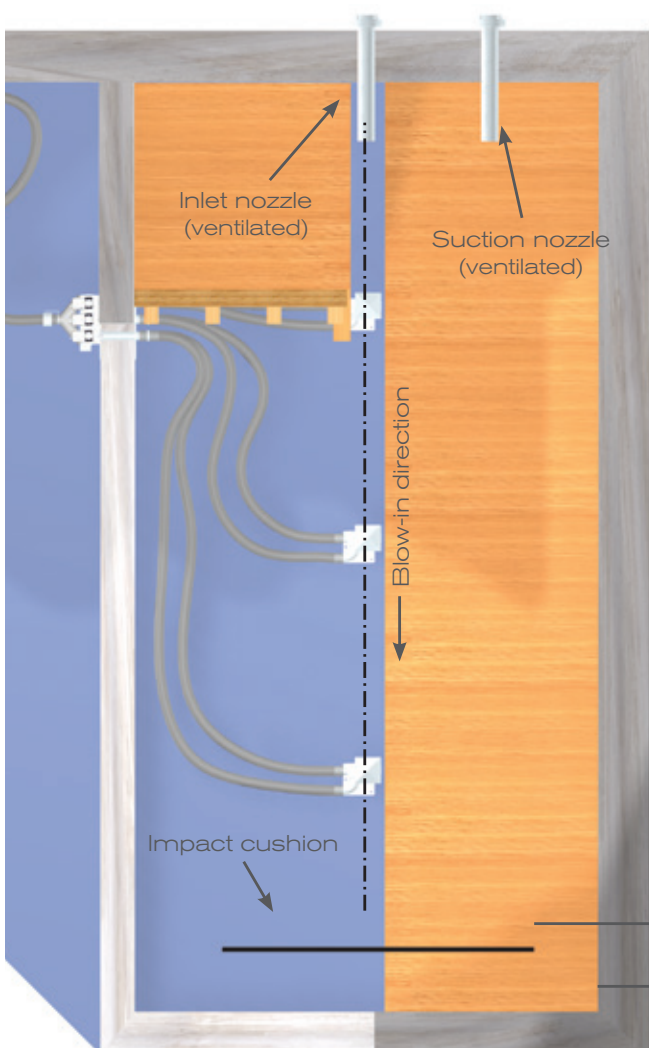

Store door

The store door must be a fire door with an EI₂ 30C fire resistance rating; it must have a seal. On the inside of the room you should install wooden boards to stop the pellets pressing against the door. Practice has shown that it is advisable to install an additional inspection window.

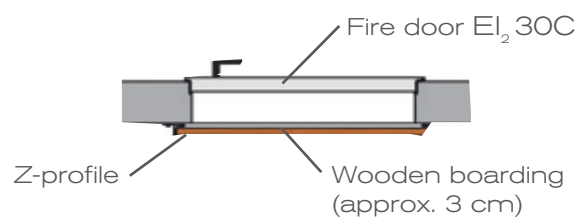
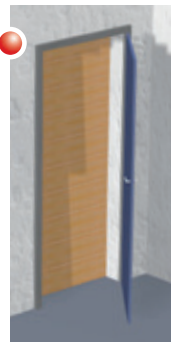

Impact cushion

The impact cushion is made of rubber and should be positioned opposite the filling pipes at least 20 cm from the wall at a right angle to the blow-in direction. During filling the cushion stops the pellets from hitting the wall and breaking up. The cushion also stops the pellets from knocking plaster off the wall. Froling can supply impact cushioning measuring 140 x 120 cm.

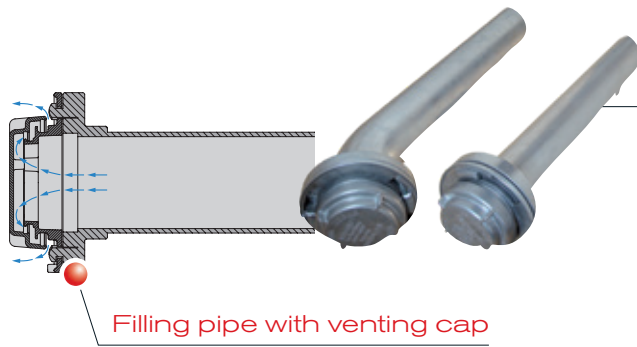

Filling couplings with venting cap

The pellets are delivered by tanker and blown into the store through a filling pipe. The second pipe is used for controlled and dust free removal of the escaping air. When installing in a lighting well, filling couplings with a 45° bend are used so that the filling hoses can be connected in a straight line.

Installing the filling coupling

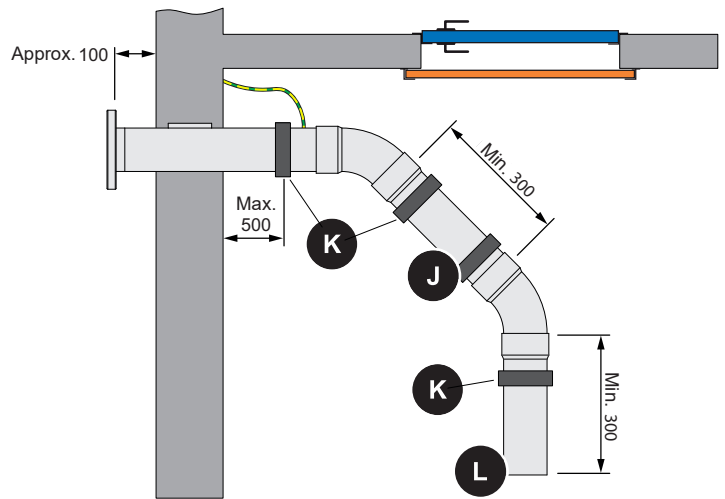
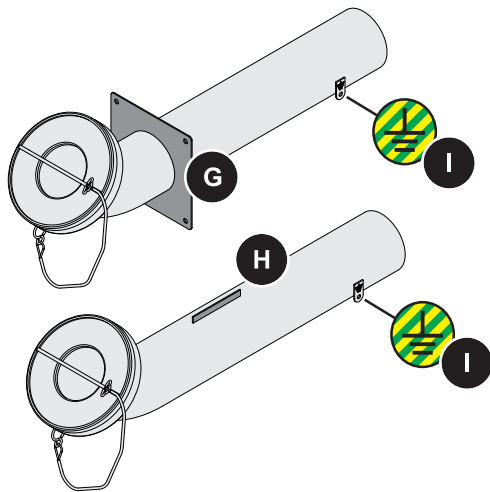

- G Filling coupling with flange
- H Filling coupling with rotation protection
- I Earth

- J Straight pipe section (Length: min. 300 mm)
- K Suitable pipe clamps
- L Straight pipe section (Length: min. 300 mm)

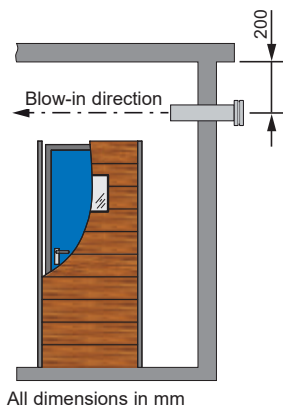

All dimensions in mm

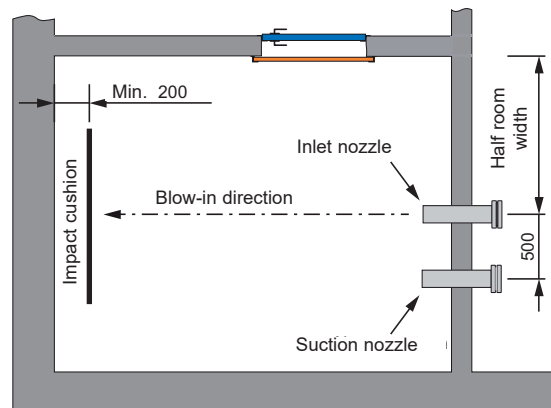

The holes in the wall for the pipes must have a diameter of at least 150 mm. Position the filling couplings 200 mm below the ceiling. To fix the filling couplings in the masonry, they must be bricked in or cemented in with rotation protection. Filler couplings that are fixed in place using foam compounds may come loose when the filling hose is coupled. The filling couplings must be earthed in order to prevent the build up of electrostatic charge.

4 PROBE MANUAL SUCTION SYSTEM

The RS 4 manual pellet suction system creates more space in your fuel store. Thanks to the fact that the suction probes are flexible in terms of location, it is possible to make optimal use of every room shape. The switchover between suction probes is manual. Rule of thumb: Plan for one suction probe for every 1 m² pellet storage area.



PELLET SUCTION SYSTEM RS 4 / RS 8

Design as above, however with the difference of automatic switchover between the suction probes.

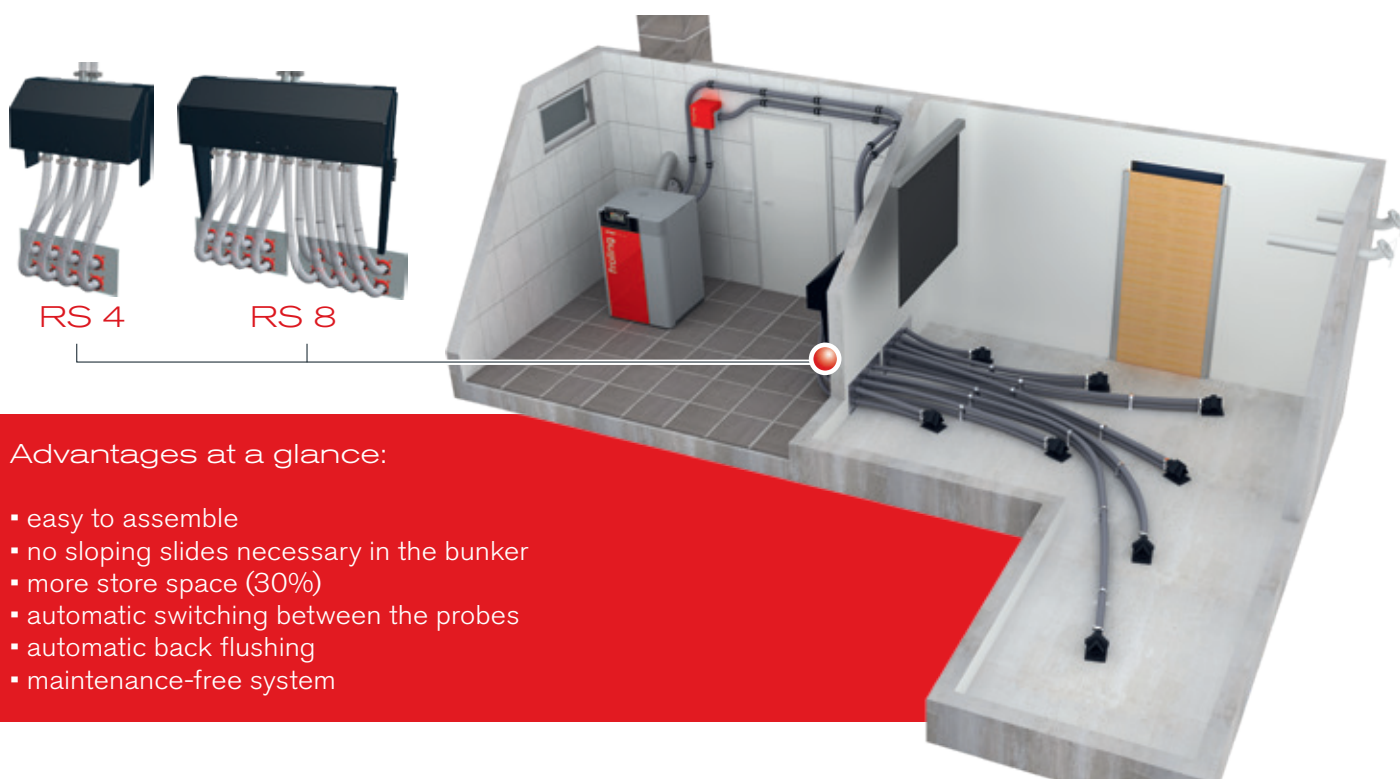

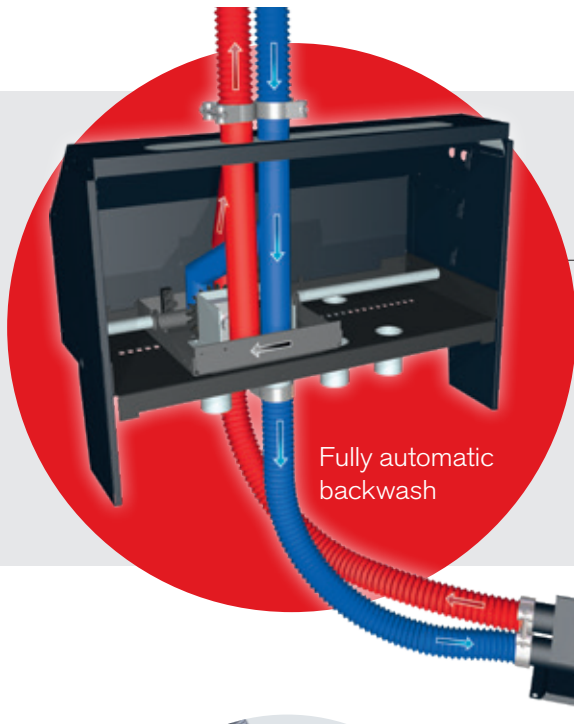

Automatic probe selection

It automatically selects 4 or 8 suction probes in specified cycles and is controlled by the pellet boiler. If, however, the suction probe fails unexpectedly, it is remedied by a fully automatic reversal of the air supply (back flushing).

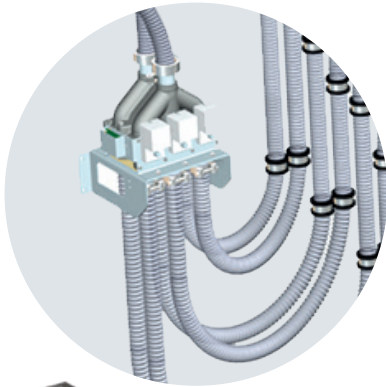

TRIPLE RS 4 / RS 8 PELLET SUCTION SYSTEM

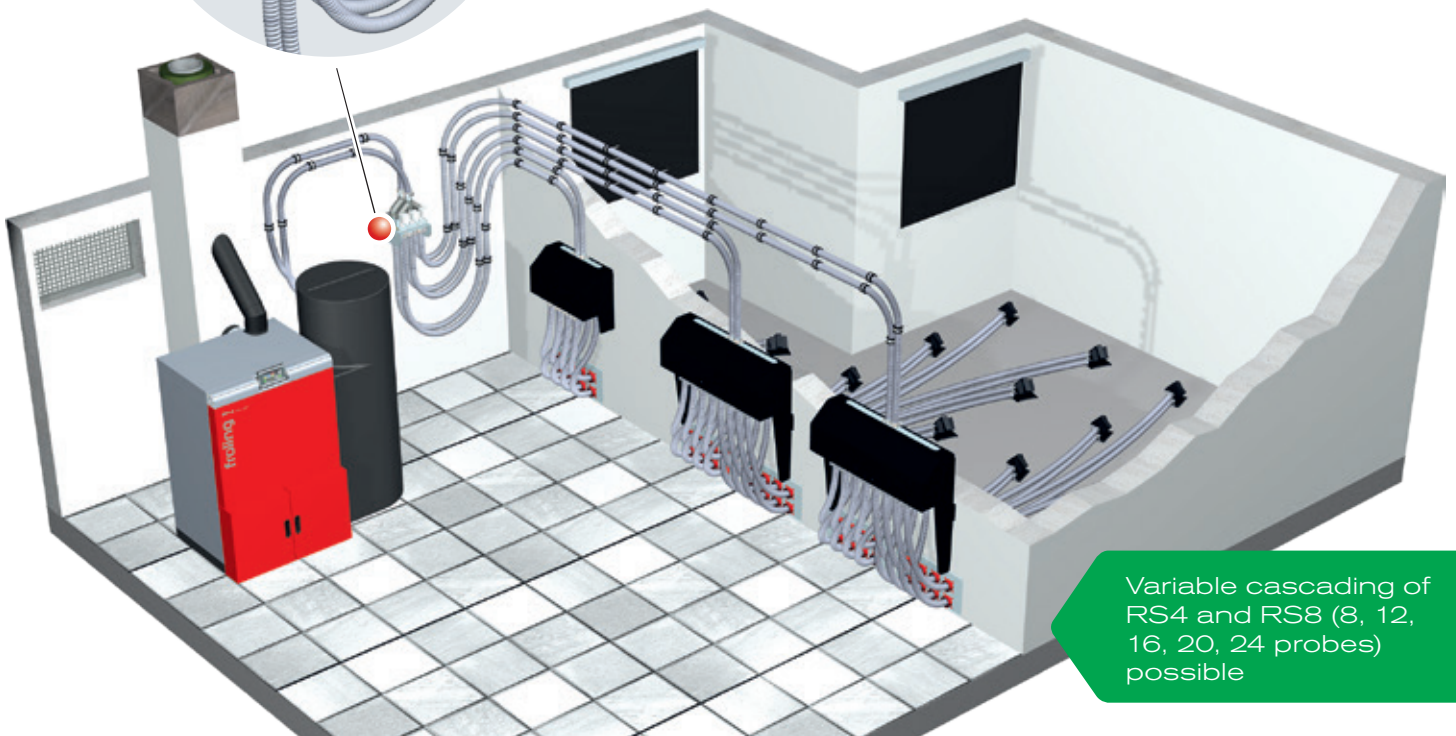

Variable cascading of RS4 and RS8 (8, 12, 16, 20, 24 probes) possible

With the combination of up to three RS4 and/or RS8, large storerooms can be equipped with up to 24 suction probes, making it possible to empty, largely without sloping floors. The controller takes over the pellet boiler, which automatically changes the probes in specified cycles to ensure that the storeroom is uniformly emptied.

If the storeroom is not being uniformly emptied, individual probes can be locked separately so that they are no longer used to convey material. If there is an unexpected fault at the suction point, an attempt is made to remedy the fault with a fully automatic reversal of the air supply (back flushing).

BEFORE INSTALLATION

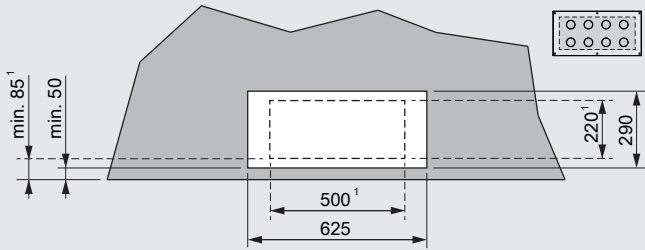

RS 4

1 Minimum measurement required to install hose lines. In addition, the fire protection panels must be adapted to the wall opening.

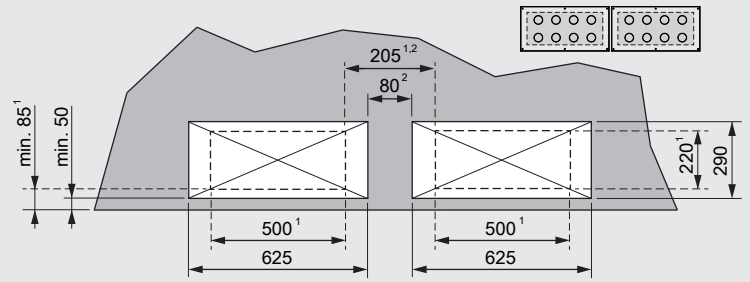

RS 8

1 Minimum measurement required to install hose lines. In addition, the fire protection panels must be adapted to the wall opening.

2 The openings in the wall are not to affect the static equilibrium of the wall. Use supports if necessary. The distance between the wall openings must be wide enough to use the supports in case of a collapse.

Refer to our installation instructions for more detailed information on installation.

FLEXIBLE STOREROOM LAYOUT - OPTIMAL USE OF SPACE

Distance between the individual probes: 500 to 1000 mm. The greater the distance between the suction probes, the more pellets will be left in the fuel store!

Rectangular store (2 rows)

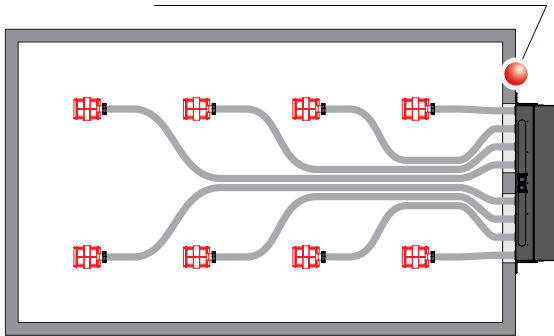

Rectangular store (1 row)

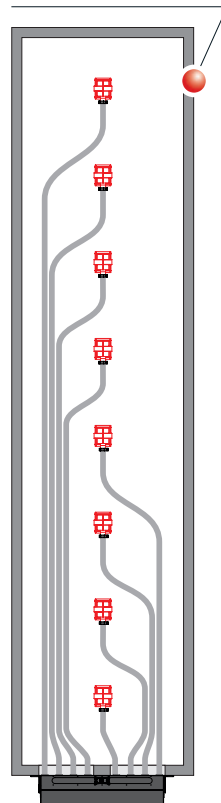

Square storeroom

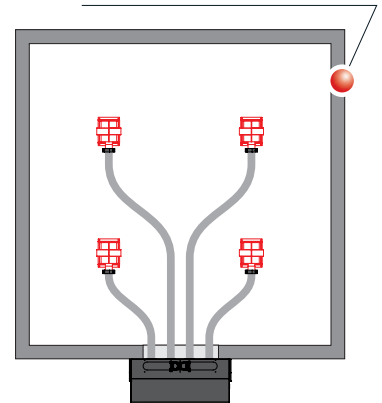

Separate stores

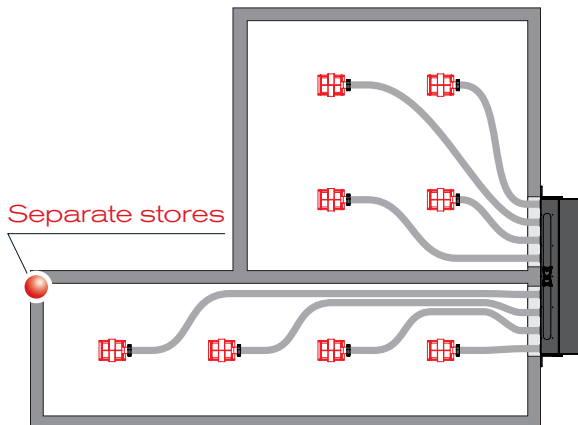

L-shaped store

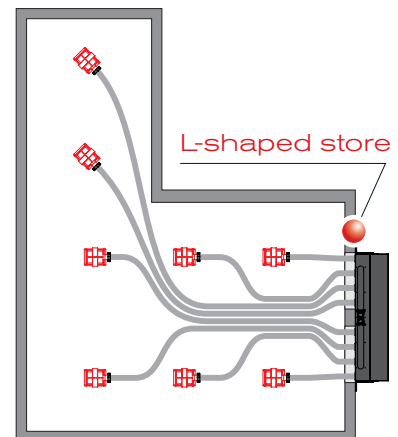

Sloping sides

In order to support the weight of pellets, the sloping sides of the store must have a strong supporting framework. The framework should be dimensioned so that the sloping sides are not deformed when subject to static loads. A large proportion of the weight must be supported on the floor and pellet trough and should not be transferred to the surrounding walls. Rule of thumb for calculating the total weight: 1 m³ pellets \triangleq 650 kg

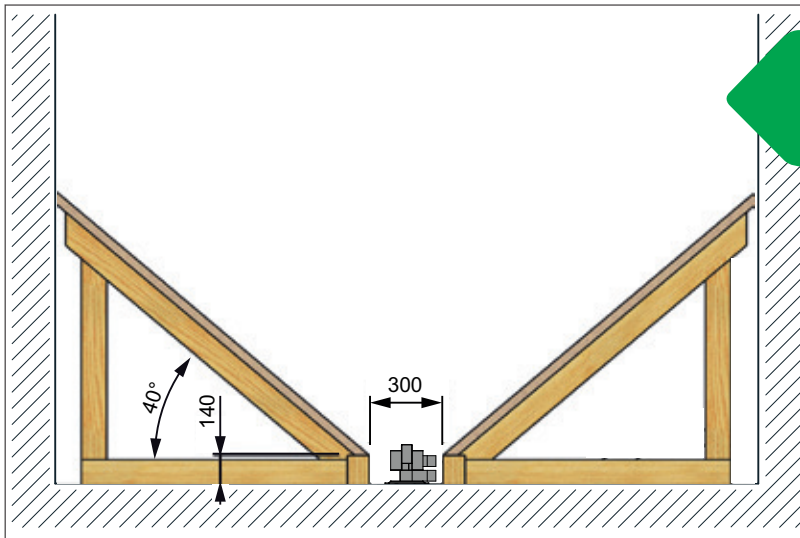

IMPORTANT: Sloping sides must not touch the walls in order to prevent the transmission of vibrations to the brickwork (structure-borne sound).

- Where possible the suction probes should be fitted before constructing the sloping sides
- Ensure a distance of 300 mm between the crosspieces
- Position the suction probes in the middle

4 suction probes, one after the other

- Distribute the probes throughout the storeroom as shown
- Ensure a distance of 300 mm between the cross-pieces

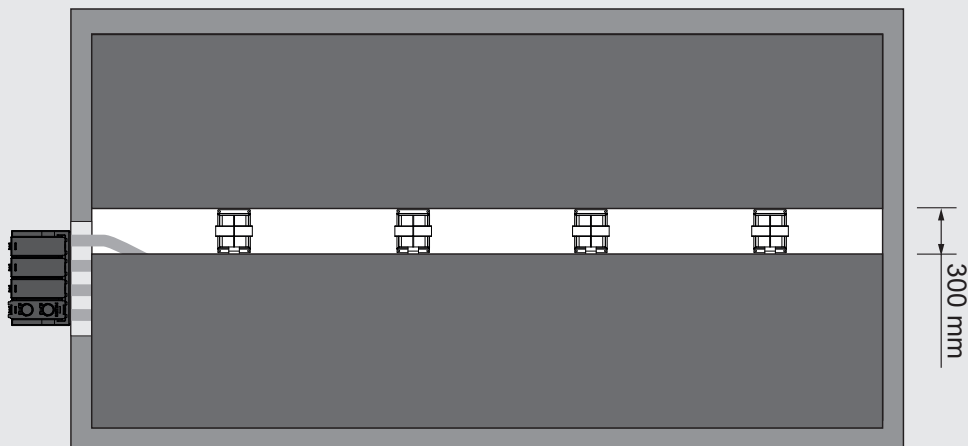

STOREROOM SIZE FROM 8 M²

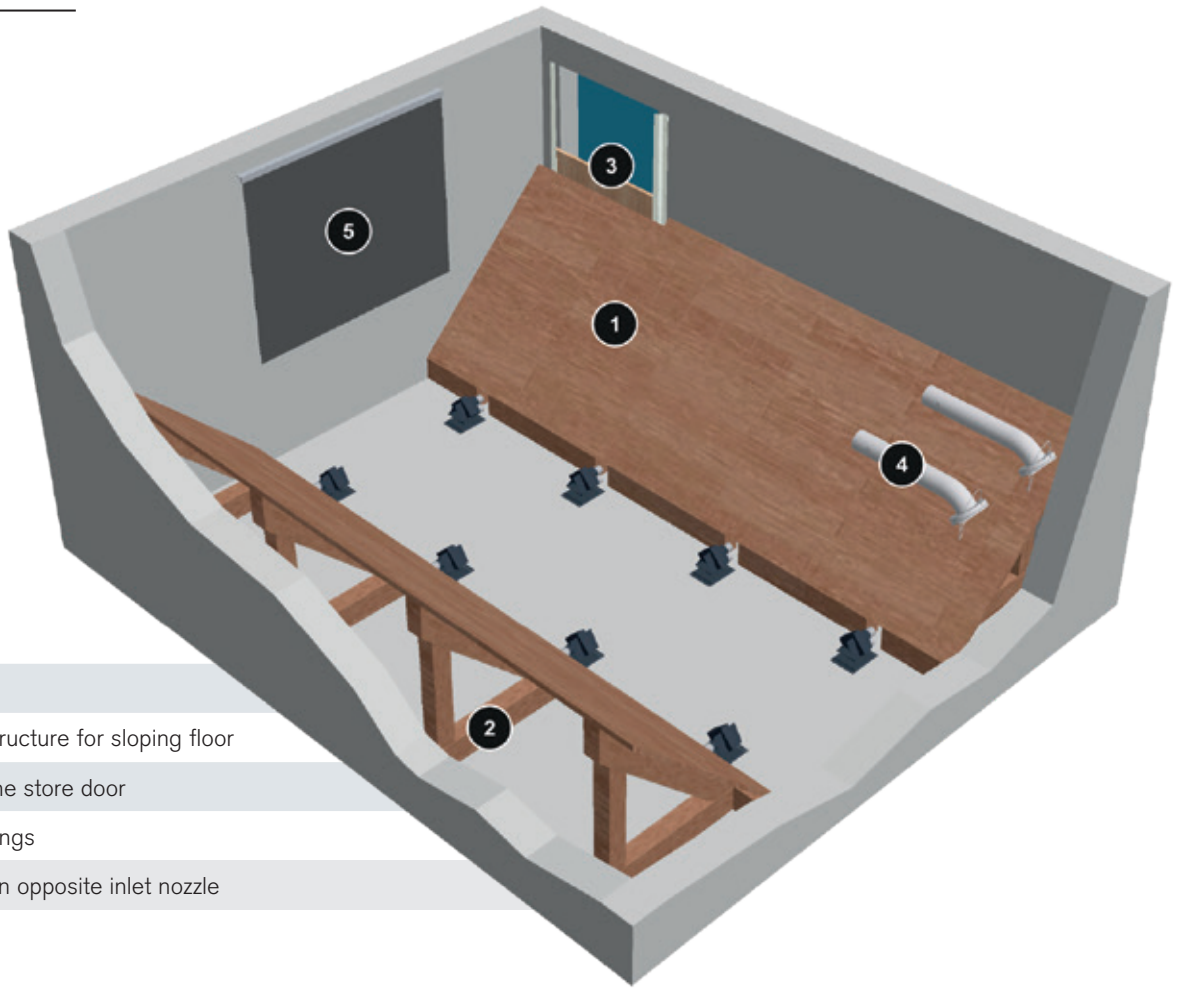

- 1 Sloping floor
- 2 Under-floor structure for sloping floor
- 3 Planking on the store door
- 4 2 filling couplings
- 5 Impact cushion opposite inlet nozzle

4x2 suction probes next to each other

- Distribute the probes throughout the storeroom as shown
- Ensure a distance of 1000 mm between the suction probes (If the distance is greater, a sloping floor between the suction probes is required)

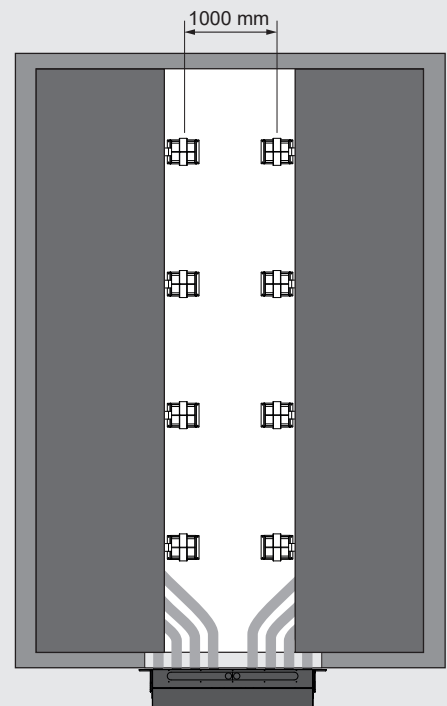
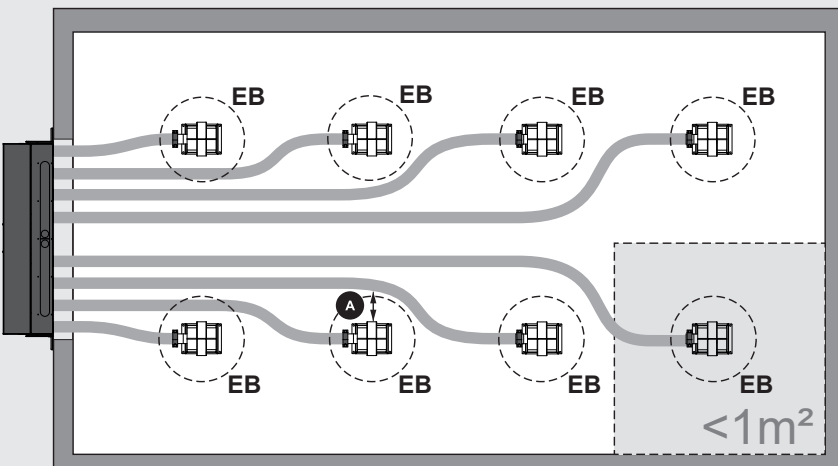

DIMENSIONS & RECOMMENDED DISTANCES

RS 4

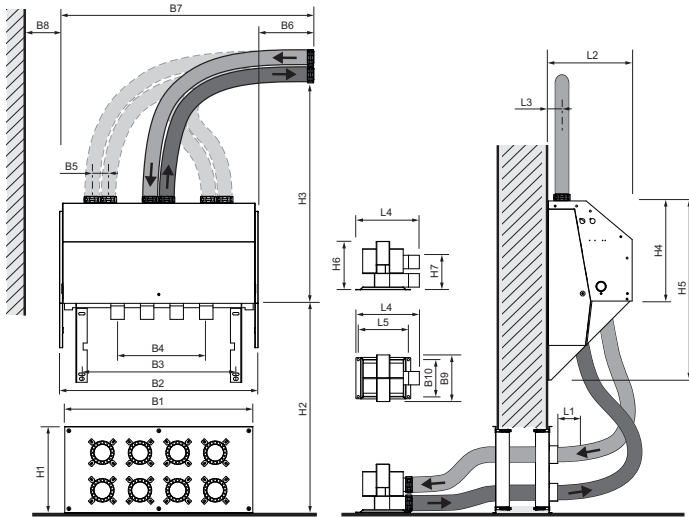

RS 8

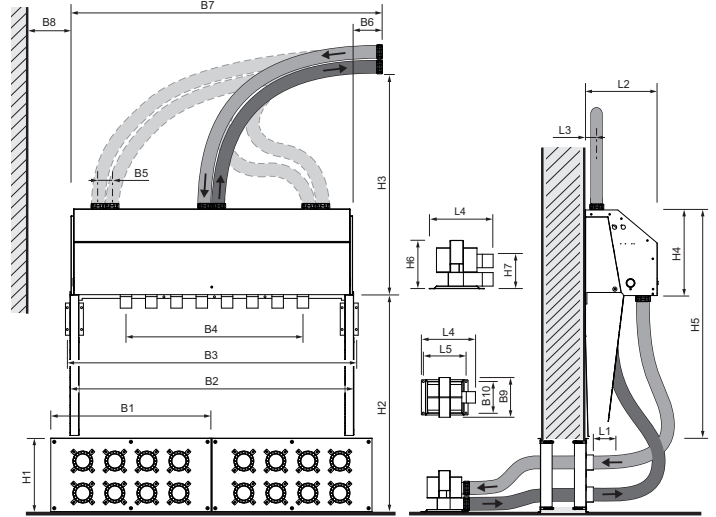

All measurements in mm.

	RS 4	RS 8
H1 Height of cover plate	352	352
H2 Recommended distance, floor to mounting bracket	>800	>990
H3 Recommended distance, mounting bracket to hose line attachment	>1175	>1175
H4 Height of suction unit	375	375
H5 Height of suction unit, including mounting bracket	665	985
H6 Height of suction probe	180	180
H7 Recommended height for cut-out sections for hose lines	>140	>140
B1 Width of cover plate	700	700
B2 Width of suction unit	740	1235
B3 Distance between mounting bracket holes	573	1258
B4 Distance between external hose line connections	330	770
B5 Distance between hose lines	62	62
B6 ¹ Recommended distance, suction unit to hose line attachment / wall	>400	>400
B7 Overall width	>1240	>1635
B8 Recommended distance, suction unit to wall	>150	>150
B9 Width of suction probe	175	175
B10 Distance between suction probe holes	138	138
L1 Recommended length of straight suction hose line piece	>100	>100
L2 Length of suction unit	315	315
L3 Distance between hose line and wall	50	50
L4 Length of suction probe	237	237
L5 Distance between suction probe holes	187	187

¹ If the hose lines run toward the top, the distance from the suction unit to the wall can be reduced to 150 mm.

Suction screw system (for oblong storerooms)

The Froling suction screw system is the ideal solution for rectangular rooms with front-end removal. The deep and horizontal position of the discharge screw means the space in the room is used optimally and complete emptying of the store is guaranteed. Combined with a suction system from Froling it also enables flexible boiler installation.



1-2-3 suction screw system (for large and oblong stores - up to 10 m)

The 1-2-3 suction screw system from Froling is the ideal solution for large stores. Depending on the size, two or three discharge screws are positioned parallel to each other and integrated into the fuel feed of the suction system. The automatic screw selector automatically switches between the suction screws in predefined cycles, ensuring that the store is emptied evenly.

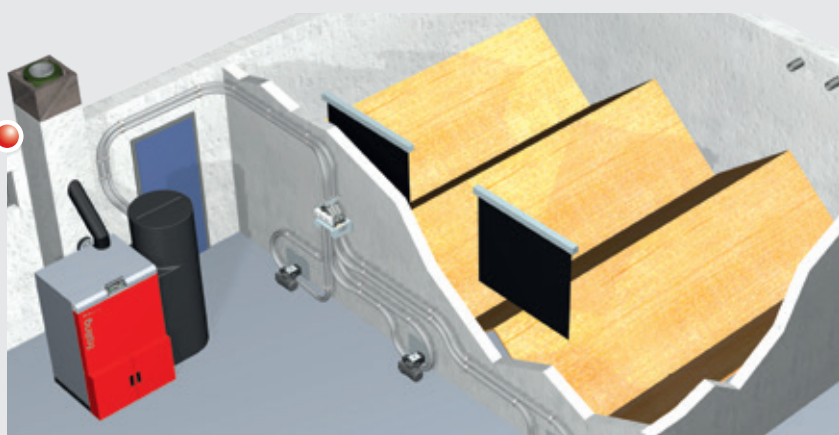

Flexible lengths

The suction screw discharge system is flexible and modular. A total of 6 metres of extension modules can be added to the basic module measuring 2 metres, providing a total length of 8.5 metres (open trough length 8 metres). The screws (Ø 80 mm) have a sturdy design and reliably convey the pellets to the suction hose, from where they are transported on to the boiler by suction turbine. We recommend a max. suction hose length of 15 metres.

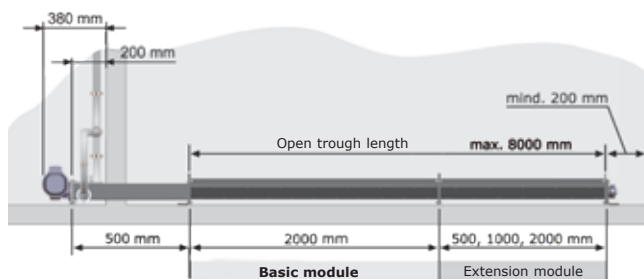

Flexible composition of modules													
Basic module (2000 mm)	1x	1x	1x	1x	1x	1x	1x	1x	1x	1x	1x	1x	1x
+++ PLUS +++													
Extension 500 mm		1x		1x		1x		1x		1x		1x	
Extension 1000 mm			1x	1x			1x	1x			1x	1x	
Extension 2000 mm					1x	1x	1x	1x	2x	2x	2x	2x	3x
Equals an open trough length of	2000	2500	3000	3500	4000	4500	5000	5500	6000	6500	7000	7500	8000

BAG SILO DISCHARGE SYSTEM



Bag silo		7	8	9	10	20	30	40	50	
B	Bag silo frame width	m	1.5	2.0	2.0	2.0	2.3	2.9	2.0	2.3
L	Bag silo frame length	m	1.25	1.25	1.5	2.0	2.3	2.9	2.9	2.9
S1	Wall to filling coupling gap	m	min. 0.30							
S2	Wall to frame gap	m	min. 0.10							
H	Bag silo frame height	m	1.9		1.82		1.9			
H1	Height including filling coupling	m	2.1		2.05		2.1			
	Required storeroom height ¹ Filling pipe below/above the crossbar	m	1.95 / 2.2		1.90 / 2.15		1.95 / 2.2			
H2	Ideal storeroom height ²	m	2.3							
	Number of filling coupling ⁴	units	1	1	1	1	1	2 ³	2 ³	2 ³
	Bulk weight	t/m ³	0.65	0.65	0.65	0.65	0.65	0.65	0.65	0.65
	Tonnage ⁴ Filling pipe above the crossbar	t	1.6	2.0	2.4	3.7	4.7	7.4	5.0	5.9
	Tonnage ⁴ Filling pipe below the crossbar	t	1.4	1.7	2.0	2.8	3.5	5.3	3.6	4.3

¹ Minimum room height for connection to filler pipe in installation room. With bag silo type 7 - 50, the filling pipe can be fitted either above or below the crossbar. This will affect the required height of the store and the tonnage.

² When completely full, the bag silo forms a hood shape.

³ 2x filling couplings for even filling, extraction is not required.

⁴ After clearing the suction probe, you should expect there to be a residual amount of at least 10% (depending on the quality of the pellets). Use the Froeling shaker for bag silo type 7 - 50 to further empty this residual amount.

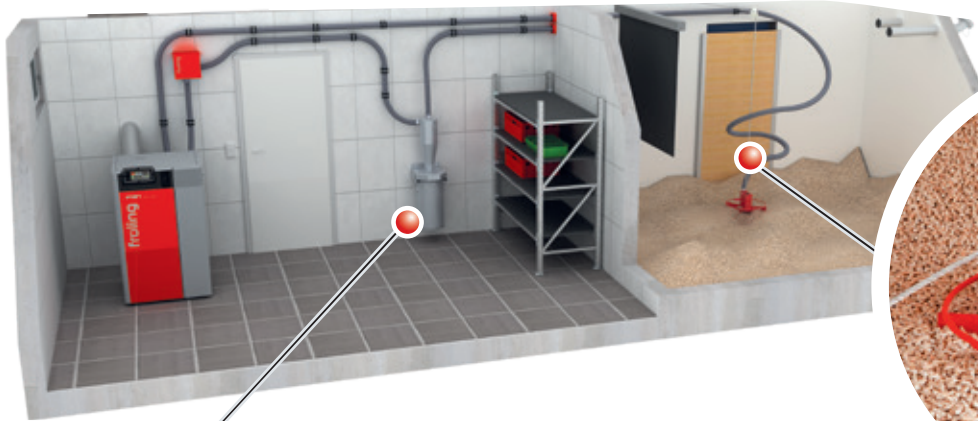

Fuel tuning with the PST pellet deduster (optional)



Wood pellets are clean and of very high quality. Any remaining wood dust can be filtered from the fuel using the PST pellet deduster. This optimises the efficiency of the combustion zone over the years. The PST pellet deduster can be fitted in any position in the return air line of the pellet suction system. The suction cyclone design means that the dust particles are separated from the return air and trapped internally. The container is convenient to remove and transport to the emptying point. The system can be retrofitted at any time and it is maintenance-free.

Pellet Mole®

This system is easy to install and makes full use of the store space. The Pellet Mole® draws the pellets from above, ensuring an optimum fuel feed to the boiler. The Pellet Mole moves automatically into every corner of the store to empty it as efficiently as possible. The pellet mole can be fitted either with a manual hoist or the Comfort module. The Comfort module is an automatic lifting system which automatically moves the pellet mole to the stand-by position when the switch is at "Fill" and lowers the pellet mole onto the pellets when the switch is at "Operate".

E3 Pellet Mole®

The new E3® pellet mole is a simple removal system based on the tried and tested pellet mole. The store can be optimally emptied without slopes. The E3® pellet mole supplies an annual pellet requirement of several hundred tonnes to pellet boilers of approx. 50 to 300 kW. A typical store size is around up to 40 tonnes of pellets or 60m³ capacity in various shapes - from round and square to rectangular, making the E3® pellet mole hugely versatile.



Cube 300/500 S pellet supply bin

The Cube 330/500 S is the optimal and most cost-effective solution for low fuel requirements. It is filled manually (e.g. pellets in sacks) and can store a total of 330/495 kg of pellets (22/33 sacks of 15 kg). The pellets are transported to the boiler by means of a suction probe, which is also included in delivery.

Dimensions for Cube 300: 690 x 690 x 1230 mm (WxDxH)
 Dimensions for Cube 500 S: 760 x 1000 x 1250 mm (WxDxH)
 Filling opening Cube 300: 600 x 295 mm (WxD)
 Filling opening Cube 500 S: 670 x 340 mm (WxD)

NEW!



Pellet box

The pellet box is assembled from guarded steel sheets on site. With the threaded nuts already pressed in, simple and quick assembly is guaranteed and drilling, cutting or welding work is not done. The same seals are already present on all components. Concerns of the self-supporting construction are not drilling or cutting work on a wall. Since the essential parts are screwed on the inside, the tank can be easily in a corner, niche or your own room. For discharge, there can be between suction using suction probes or screw conveyor systems.

- All sheet metal parts including the upright galvanized
- All screw connections on the inside, therefore the Tank is already mounted directly on the wall and no longer needs to be finished
- Self-supporting construction, no no bacteria Measures caused

CALCULATING THE STORE SIZE

Example: store for P4 Pellet 15

10 m³ pellets = approx. 6,500 kg pellets
(approx. 3250 litres of heating oil)

Boiler heating load = storeroom volume
15 kW = 15 m³

Store volume / store height = area
15 m³ / 2.5 m = 6 m²

Pellet fuel specification (standardised to EN ISO 17225-2 class A1)

Energy content	4,9 kWh/kg	Water content	max. 10%
Diameter	6 mm	Proportion of ash	max. 0,7%
Length	5 to 30 mm (1% to 45 mm)	Dust content	max. 1,0%
Surface	smooth	Pressing aid	max. 2%
Bulk weight	min. 600 kg/m ³		

Comparison of fuels

Wood pellets	4,9 kWh/kg
Anthracite coal	7 kWh/kg
Coke	7,5 - 8kWh/kg
Wood chips	750 - 850 kWh/srm
Natural gas	9,5 - 10,2 kWh/m ³
Wood fuel (soft)	1300 - 1700 kWh/rm
Liquefied gas	12,8 kWh/kg
Wood fuel (hard)	1700 - 2400 kWh/rm
Heating oil EL	10 kWh/l

Comparison of pellets and heating oil EL

2 kg of pellets - approx. 1 litre of heating oil EL
650 kg pellets - approx. 1m³ space required
3 m³ of pellets - approx. 1000 litres of heating oil EL



Pellet boiler

PE1 Pellet	7 - 35 kW
PE1c Pellet	16 - 22 kW
P4 Pellet	48 - 105 kW



Firewood boiler

S1 Turbo	15 - 20 kW
S3 Turbo	20 - 45 kW
S4 Turbo	22 - 60 kW

Dual fuel boiler

SP Dual compact	15 - 20 kW
SP Dual	22 - 40 kW



Wood chip / Large boilers

T4e	20 - 350 kW	TI	350 kW
Turbomat	150 - 500 kW	Lambdamat	700 - 1500 kW

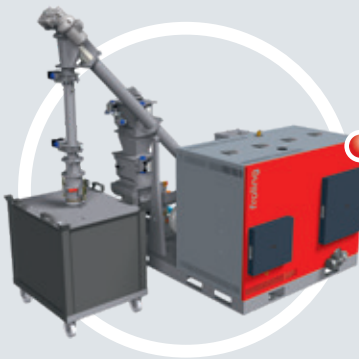

Wood combined heat and power

Fixed-bed gasifier CHP	45 - 500 kWel
------------------------	---------------

Your Fröling partner

Fröling Heizkessel- und Behälterbau Ges.m.b.H.
A-4710 Grieskirchen, Industriestr. 12

AT: Tel +43 (0) 7248 606-0
Fax +43 (0) 7248 606-600

DE: Tel +49 (0) 89 927 926-0
Fax +49 (0) 89 927 926-219

E-mail: info@froeling.com
Web: www.froeling.com