



► Katherm HK
trench heaters

Katherm HK

Heating or cooling with energy-efficient EC tangential fan

► **Technical catalogue**

Contents

01 ▶ Product information	6
▶ Katherm HK – decentralised room climate from the floor	7
▶ Product data	10
▶ Selection guide	11
▶ Katherm HK at a glance	12
▶ Katherm HK E	14
▶ Matching grilles	15
▶ Katherm HK with optional supply air function	16
▶ Katherm HK – supply air trenches ZL	18
02 ▶ Technical data	20
▶ Advice on measuring conditions	21
▶ Katherm HK, HK 245, 2-pipe, Height 160 mm	22
▶ Katherm HK, HK 245, 4-pipe, Height 160 mm	24
▶ Katherm HK, HK 290, 2-pipe, Height 160 mm	26
▶ Katherm HK, HK 290, 4-pipe, Height 160 mm	28
▶ Katherm HK, HK 320, 2-pipe, Height 130 mm	30
▶ Katherm HK, HK 320, 4-pipe, Height 130 mm	32
▶ Katherm HK, HK 320 E, 2-pipe electric heating element, Height 130 mm	34
▶ Katherm HK, HK 360, 2-pipe, Height 210 mm	36
▶ Katherm HK, HK 360, 4-pipe, Height 210 mm	38
03 ▶ Design information	40
▶ Information on planning and design	41
▶ Water connections – Pipe openings	44
04 ▶ Controls	46
▶ 24V electromechanical version	46
▶ Control of Katherm HK electromechanical version (*00)	50
▶ Control of Katherm HK, KaControl version	59
▶ The all-inclusive solution!	59
▶ KaControl – Integration into intelligent building networks (IoT)	66
▶ KaControl – system controller	67
05 ▶ Ordering information	70
▶ Accessories	70



Katherm HK:
on-demand heating
and cooling from
the floor, individually
controlled.



A special design of Kathern HK trench system with energy-efficient EC tangential fans ensures quiet operation and energy-savings in the new ADAC headquarters in Munich. This design of trench system produces demand-led filtered, heated or cooled recirculating air from the floor.

Kathern HK and Kathern HK empty trenches are individually adapted to the curved external façade in this building.

01 ▶ Product information



Katherm HK – decentralised room climate from the floor

Heaters positioned in front of windows are often unacceptable for aesthetic reasons in modern offices and other buildings with large glazed windows. At the same time, the needs of the users with regard to the climate in the space are also increasing.

The demand-led supply of filtered, heated or cooled recirculating air with Katherm HK units solves both problems at the same time, practically and invisibly from the floor. A higher level of efficiency is achieved with energy efficient EC tangential fans with noise-optimised commutation electronics, resulting in energy-savings of up to 60% compared with conventional fans!

Flow-optimised barrel impellers ensure quiet operation and guarantee that air flows through the coil along its entire length.

Katherm HK E – with additional directly selectable electric heating function

Electric heating is possible in addition to water-based heating and cooling with the 2-pipe Katherm HK E version with an integrated continuously variably controlled electric heating element.

Compared to a purely water-based system, the user of the room has the option of individual heating independently of the available water temperature. The use of the Katherm HK E means that there is less frequently a need for a switch-over between heating and cooling in transitional heating phases compared to a purely water-based 4-pipe system. This saves energy and enables the user to flexibly create their ideal climate.

KaControl

Katherm HK are available ex-works with integral KaControl. The KaController room control unit enables up to six units in a group to be operated autonomously. The units can be integrated into higher-level automation systems, such as KNX or Modbus, via optional interfaces. There is also a control option with a 0-10 V fan control if complete control is to be provided on site.

Installation examples and arrangement of the air outlet

Example of a cooling unit

(Installation in screed, Katherm HK 320, trench height 130 mm)

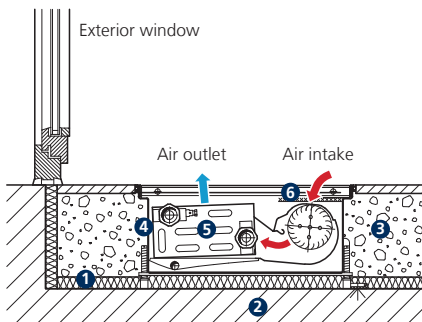

- 1 Heat and sound insulation
- 2 Concrete floor
- 3 Screed
- 4 Floor trench
- 5 High-output convector
- 6 Filter (optional)

Example of a heating unit

(Installation in a raised floor, Katherm HK 290, trench height 160 mm)

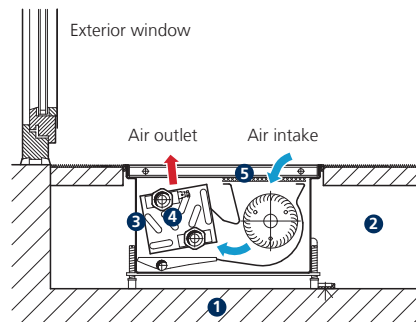

- 1 Concrete floor
- 2 Raised floor
- 3 Floor trench
- 4 High-output convector
- 5 Filter (optional)

Example of a cooling unit

(Installation in a raised floor, Katherm HK 360, trench height 210 mm)

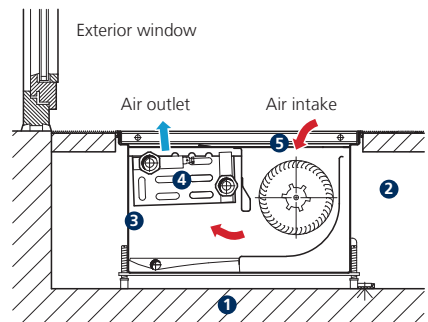

- 1 Concrete floor
- 2 Raised floor
- 3 Floor trench
- 4 High-output convector
- 5 Filter (optional)

Example of a heating unit

(Installation in screed, Katherm HKE 320 E, trench height 130 mm)

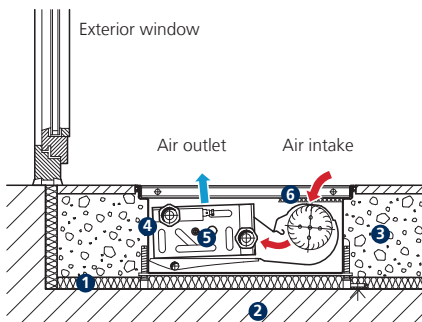

- 1 Heat and sound insulation
- 2 Concrete floor
- 3 Screed
- 4 Floor trench
- 5 High-output convector
- 6 Filter (optional)

Example of a cooling unit

(Installation in a raised floor, Katherm HK 245, trench height 160 mm)

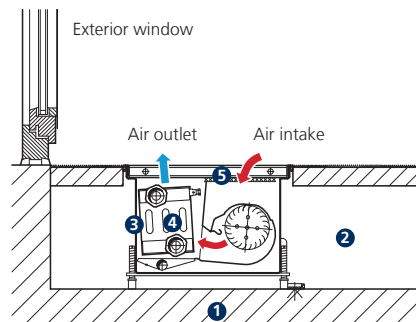

- 1 Concrete floor
- 2 Raised floor
- 3 Floor trench
- 4 High-output convector
- 5 Filter (optional)

Product data



Product benefits

- ▶ Hygiene conforms to VDI 6022: simple cleaning
- ▶ Heat outputs tested independently in accordance with DIN EN 16430
- ▶ EC fan - efficient in terms of noise and energy
- ▶ Low-cost effective heating and cooling with low noise levels
- ▶ Matching frame for every roll-up grille for a perfect overall look
- ▶ Eurokonus valve connection for fast installation

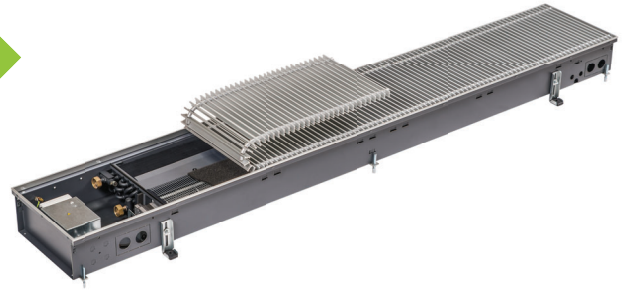

Features

- ▶ Energy-saving EC tangential fan with flow-optimised impellers
- ▶ Condensate tray can be removed to the room side for complete cleaning
- ▶ Sound-decoupled fixing of the tangential fan, easy removal without tools
- ▶ Connection and control box for fast and safe electrical connection
- ▶ Condensate pump mounting kit, supplied separately or factory-fitted
- ▶ Extensive range of control accessories
- ▶ Roll-up and linear grilles with colour-coordinated spacers

Convection	▶ EC tangential fan
Heating	▶ LPHW
Cooling	▶ CHW
Ventilation	▶ Optionally by supply-air modules or air supply ducts
KaControl	▶ Optional

Performance data

Heat output [W]¹⁾ > 436 – 16884

Cooling output [W]²⁾ > 62 – 3348

Sound pressure level [dB(A)]³⁾ > 20 – 53

Sound power level [dB(A)] > 28 – 61

¹⁾ at LPHW 75/65 °C, $t_{l1} = 20$ °C

²⁾ at CHW 16/18, $t_{l1} = 27$ °C, 48% relative humidity

³⁾ The sound pressure levels were calculated with an assumed room insulation of 8 dB(A). This corresponds to a distance of 2 m, a room volume of 100 m³ and a reverberation time of 0.5 s (in accordance with VDI 2081)

Operating limits

- ▶ Max. operating pressure: 10 bar
- ▶ Max. entering water temperature: 95 °C
- ▶ Min. entering water temperature: 5 °C
- ▶ Inlet air temperature: 40 °C
- ▶ Max. glycol volume: 50 %

Applications

Buildings of all kinds, in which there is a high cooling load due to internal loads and the effects of sunlight. Experience has shown that Katherm HK can provide low-cost, effective cooling with low, non-disruptive sound levels.



Selection guide

System							Height (C) [mm]	Width (B) [mm]	Length (A) [mm]	
2-pipe		2-pipe electric heating element			4-pipe					
heat output LPHW ¹⁾ [W]	Cooling output ²⁾ [W]	electric heat output ³⁾ [W]	heat output LPHW ¹⁾ [W]	Cooling output ²⁾ [W]	heat output LPHW ¹⁾ [W]	Cooling output ²⁾ [W]				
697 – 1764	125 – 384	200 – 500	767 – 1960	91 – 274	436 – 1085	121 – 373	130	320	915	
1025 – 2908	189 – 571	400 – 1000	1379 – 3248	153 – 517	726 – 1809	184 – 552			1200	
1696 – 5232	223 – 964		1565 – 4933	214 – 927	1307 – 3256	214 – 927			1700	
1884 – 5814	247 – 1071		1739 – 5481	238 – 1030	1452 – 3618	238 – 1030			2000	
2612 – 8139	289 – 1491	600 – 1500	1980 – 7410	310 – 1442	2033 – 5065	333 – 1442			2500	
3382 – 10465	387 – 1925		2649 – 9716	411 – 1854	2614 – 6512	370 – 1851			3000	
637 – 1452	66 – 251	---	---	---	462 – 1053	62 – 237	160	245	915	
1061 – 2420	110 – 419	---	---	---	770 – 1755	103 – 394			1200	
1910 – 4355	198 – 754	---	---	---	1385 – 3158	186 – 710			1700	
2123 – 4839	220 – 837	---	---	---	1539 – 3509	207 – 789			2000	
2972 – 6775	308 – 1172	---	---	---	2155 – 4913	290 – 1104			2500	
3821 – 8710	395 – 1507	---	---	---	2771 – 6316	372 – 1420		3000		
1057 – 3286	114 – 486	---	---	---	514 – 1639	112 – 476		290	950	
1599 – 4851	165 – 801	---	---	---	852 – 2718	162 – 785			1200	
1657 – 7262	212 – 1284	---	---	---	1366 – 4357	207 – 1258			1700	
2149 – 9420	275 – 1665	---	---	---	1771 – 5652	269 – 1632			2000	
2283 – 12055	333 – 2148	---	---	---	2285 – 7291	347 – 2105	2500			
3085 – 15715	444 – 2783	---	---	---	2961 – 9448	435 – 2728	3000	210	360	950
1223 – 4645	120 – 818	---	---	---	643 – 2982	114 – 771	1200			
1933 – 7152	185 – 1352	---	---	---	1066 – 4944	176 – 1273	1350			
2332 – 8667	222 – 1674	---	---	---	1320 – 6121	211 – 1576	1850			
2708 – 12555	281 – 2489	---	---	---	1964 – 9104	264 – 2344	2250			
3642 – 16884	377 – 3348	---	---	---	2641 – 12243	356 – 3153				

¹⁾ at LPHW 75/65 °C, t_{r1} = 20 °C, with fan coils

²⁾ with CHW 16/18 °C, t_{r1} = 27 °C, 48% rel. humidity, with fan coils

³⁾ when operating with an electric heating element

Technical drawing (Dimensions in mm)

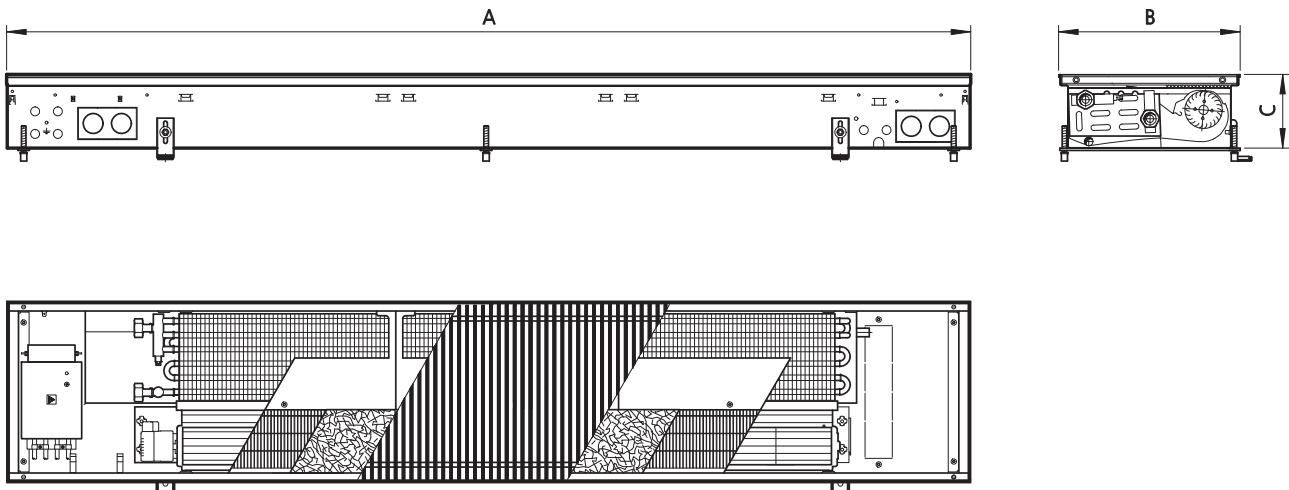

Katherm HK at a glance

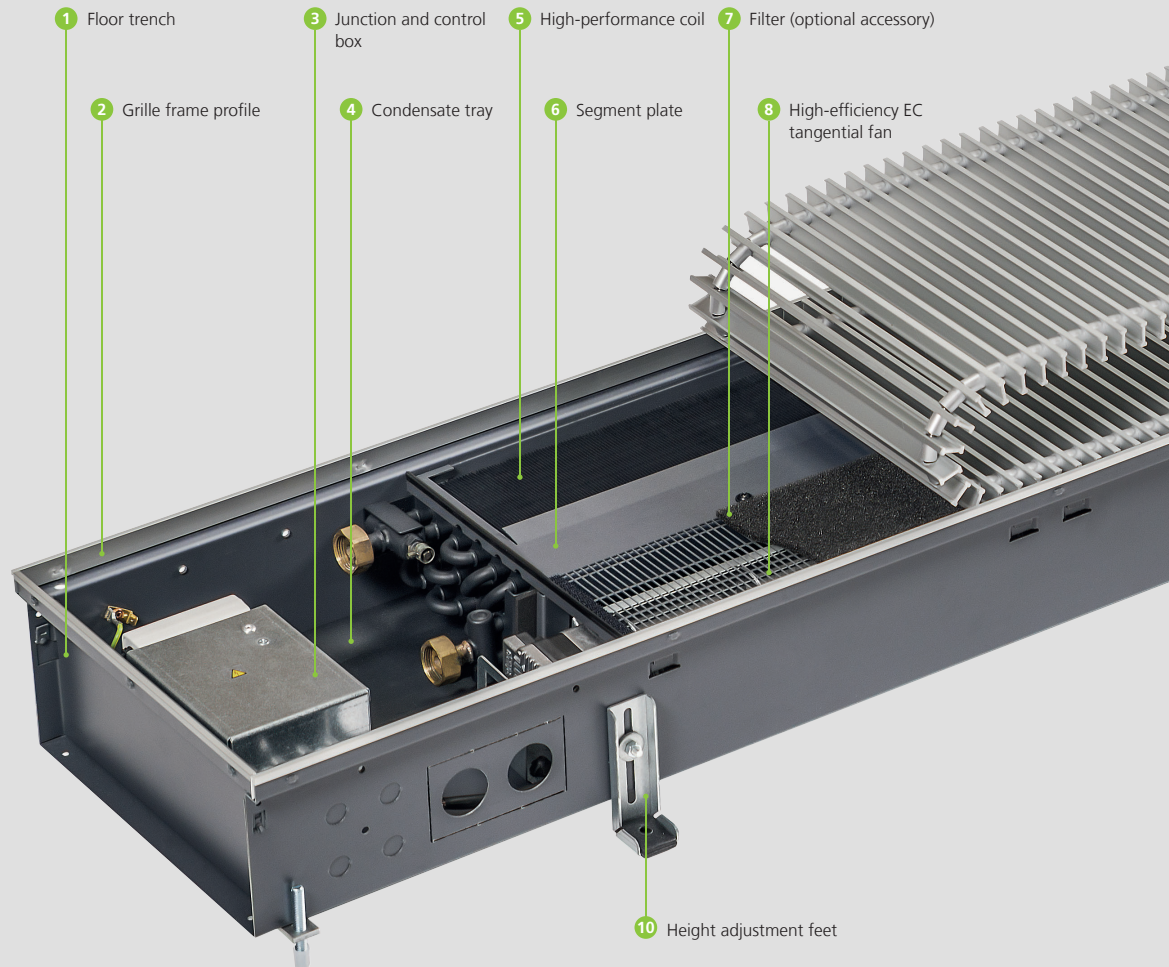

Features

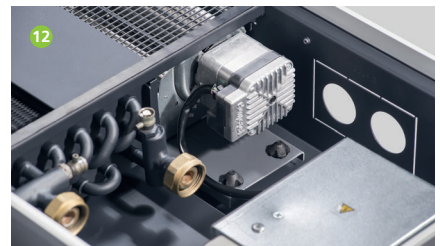
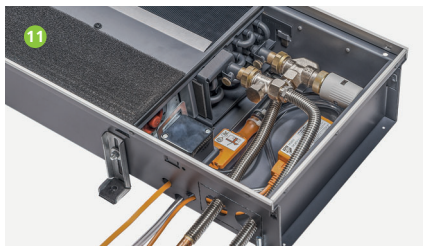
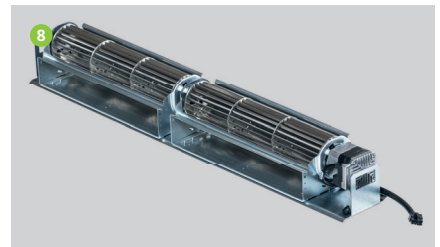
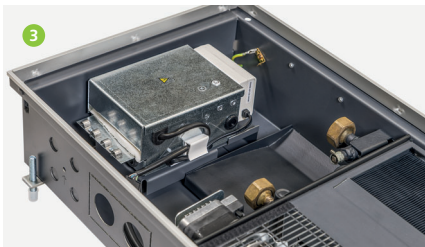

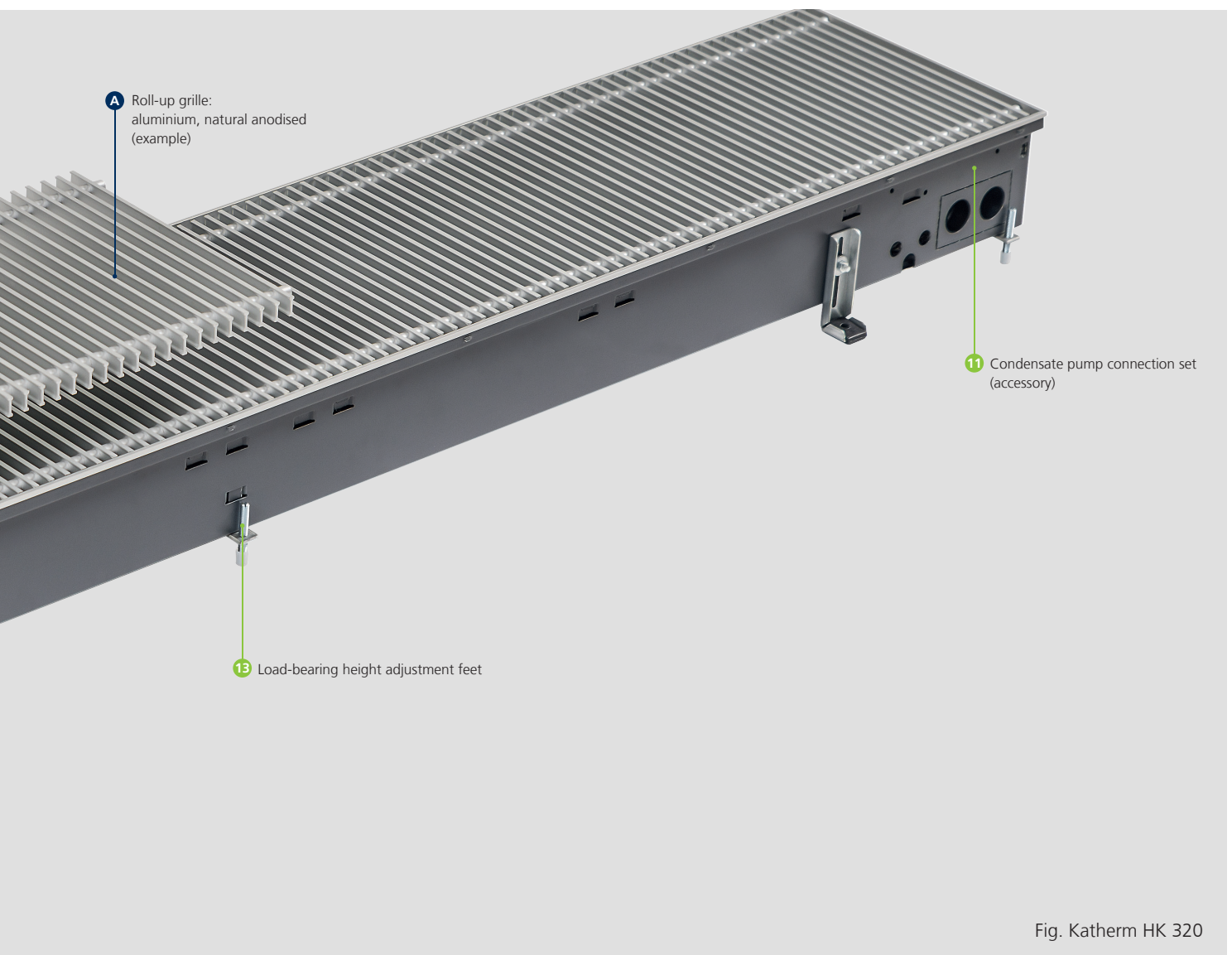

Fig. Katherm HK 320

- 1 Floor trench:**
 - ▶ galvanised sheet steel
 - ▶ painted graphite grey on both sides
- 2 Grille frame profile:**
 - ▶ to match double T-profile grille
 - ▶ with protective lip on 3 sides
- 3 Junction and control box:**
 - ▶ for fast and safe electrical connection, saves installation time
 - ▶ with KaControl or electromechanical control
- 4 Condensate tray:**
 - ▶ for the safe discharge of the condensate and simultaneous air guidance
 - ▶ specifically designed for ease of cleaning in line with the Hygiene Directive VDI 6022
 - ▶ can be removed to the room side for ease of cleaning
- 5 High-performance coil:**
 - ▶ made of copper pipes with aluminium fins
 - ▶ painted graphite-grey
 - ▶ suitable for maximum continuous operating pressure of 10 bar and 120°C
 - ▶ Eurokonus connection
 - ▶ for 2-pipe and 4-pipe system
- 6 Segment plate:**
 - ▶ acts as a finger guard for the tangential fan, filter frame, airflow baffle, grille seat and reinforcing braces to strengthen the trench
- 7 Filter:**
 - ▶ optional accessory
- 8 High-efficiency EC tangential fan:**
 - ▶ energy-saving, with flow-optimised impellers, cascaded arrangement as a continuous fan belt (HK 320)
 - ▶ produces a uniform air flow through the coil
 - ▶ robust and quiet motor design
 - ▶ continuously variable speed control via an external 0-10 V signal
 - ▶ motor monitoring with internal fault processing
- 9 Cover plate:**
 - ▶ visual protection and to protect against dirt
 - ▶ for connecting/return end and intermediate sections
- 10 Height adjustment feet:**
 - ▶ for the secure mounting of the trench
 - ▶ with sound insulation
 - ▶ as standard
- 11 Condensate pump fitting kit:**
 - ▶ available as an accessory to drain condensate, if needed
 - ▶ supplied separately or factory-fitted
 - ▶ electrically wired on site
- 12 Tangential fan fixing:**
 - ▶ ease of removal of the tangential fan without a tool
 - ▶ innovative combined coupling/ball joint system
 - ▶ simultaneous acoustic decoupling
- 13 Load-bearing height adjustment feet:**
 - ▶ for height adjustment and support of the trench
- A Aluminium, natural anodised roll-up grille (example):**
 - ▶ grille bar dimensions 18 x 5 mm
 - ▶ connections made of corrosion-proof steel springs with spacers in a matching colour
 - ▶ free cross-section approx. 70%

Katherm HK E

Katherm HK E units are designed as 2-pipe units. The use of these trench coils means that there is no need for the complete routing of pipes for a 4-pipe system in the floor and riser including all fittings and valves. This

results in considerable savings during installation and in terms of material consumption, which, in turn, delivers cost savings.

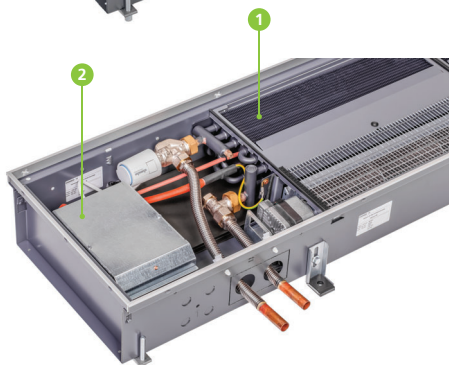
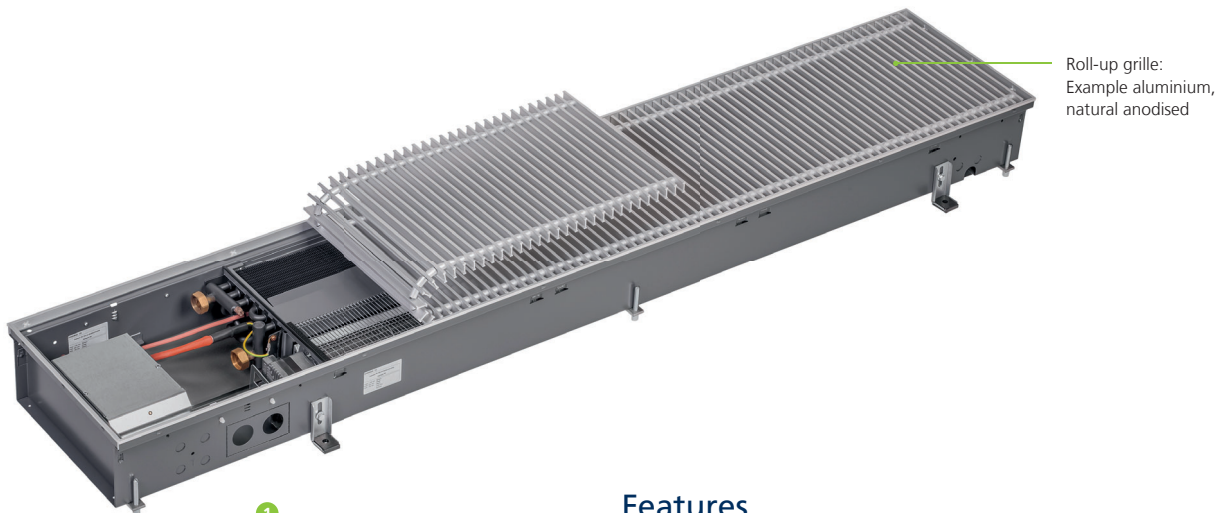
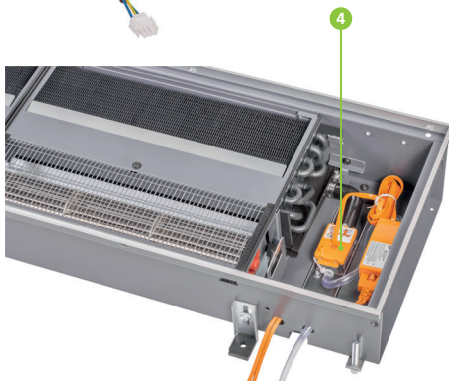

Illustration shows valves, actuator and corrugated pipes (all accessories)



Features

- 1 High-output convector with integral electric heating element and safety chain**
 - ▶ made of copper pipe with aluminium fins
 - ▶ painted graphite-grey
 - ▶ suitable for maximum continuous operating pressure of 10 bar and 120°C (water-side)
 - ▶ with integral electric heating element for direct and individual heating
 - ▶ with built-in safety chain consisting of 2 safety temperature switches
 - ▶ 2-pipe system
 - ▶ Eurokonus connection
- 2 Junction and control box**
 - ▶ for KaControl or electromechanical control
 - ▶ for quick and safe electrical connection
 - ▶ for factory connection and wiring of the electric heating element and safety chain
- 3 Electric heating element**
 - ▶ made of stainless steel
 - ▶ with isolating hose and plug
- 4 Condensate pump fitting kit**
 - ▶ available as an accessory to drain condensate, if needed
 - ▶ assembly supplied separately or factory-fitted
 - ▶ electrically wired on site

Matching grilles

Roll-up grilles

Aluminium
Natural anodised

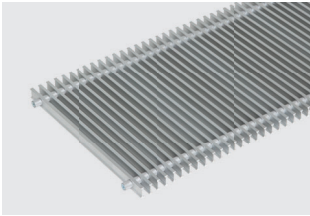

Aluminium
Brass anodised

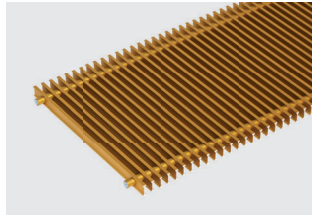

Aluminium
Bronze anodised

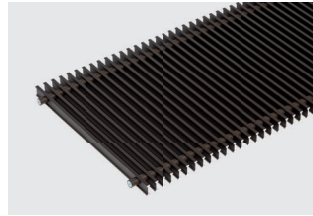

Aluminium
Black anodised

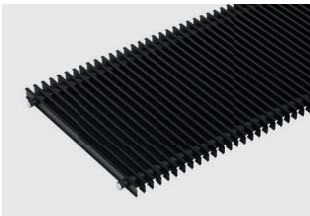

Aluminium
Light Bronze

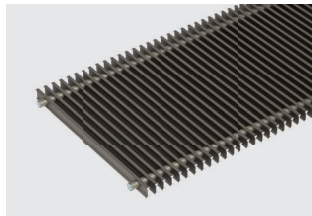

Aluminium
Painted DB 703

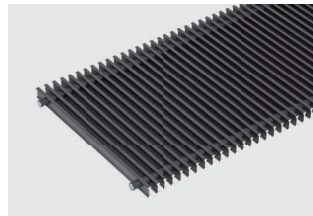

Stainless steel
Natural

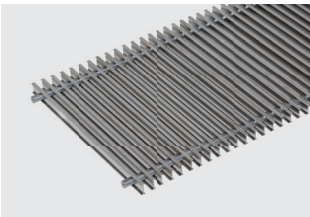

Stainless steel
Polished

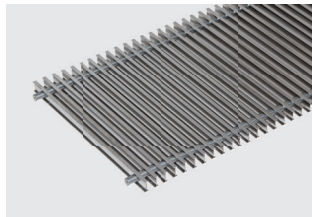

Brass
Natural

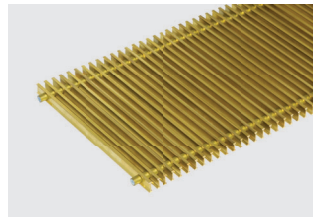

Linear grilles

Aluminium
Natural anodised

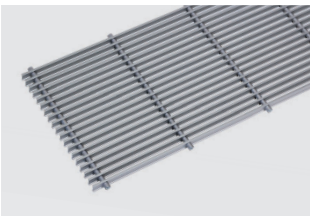

Aluminium
Brass anodised

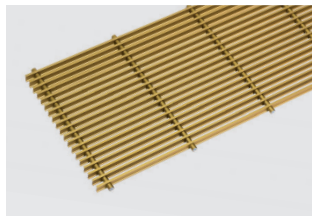

Aluminium
Bronze anodised

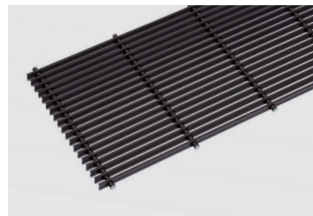

Aluminium
Light Bronze

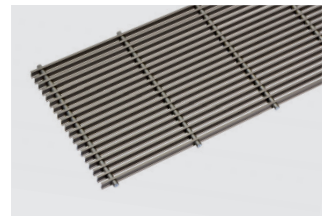

Profile dimensions

Double-T profile

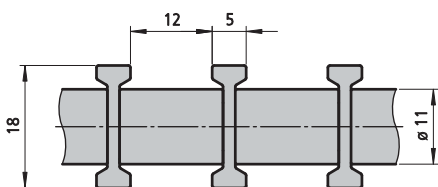

Aluminium, brass

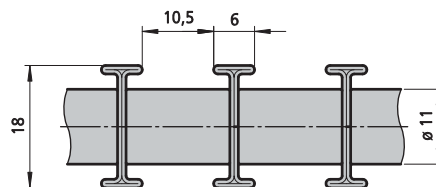

Stainless steel

► other grille finishes can be viewed at Kampmann.de/roste

The above grilles are shown using a four-colour printing process and thus do not represent an exact reproduction of the original colour.

Katherm HK with optional supply air function

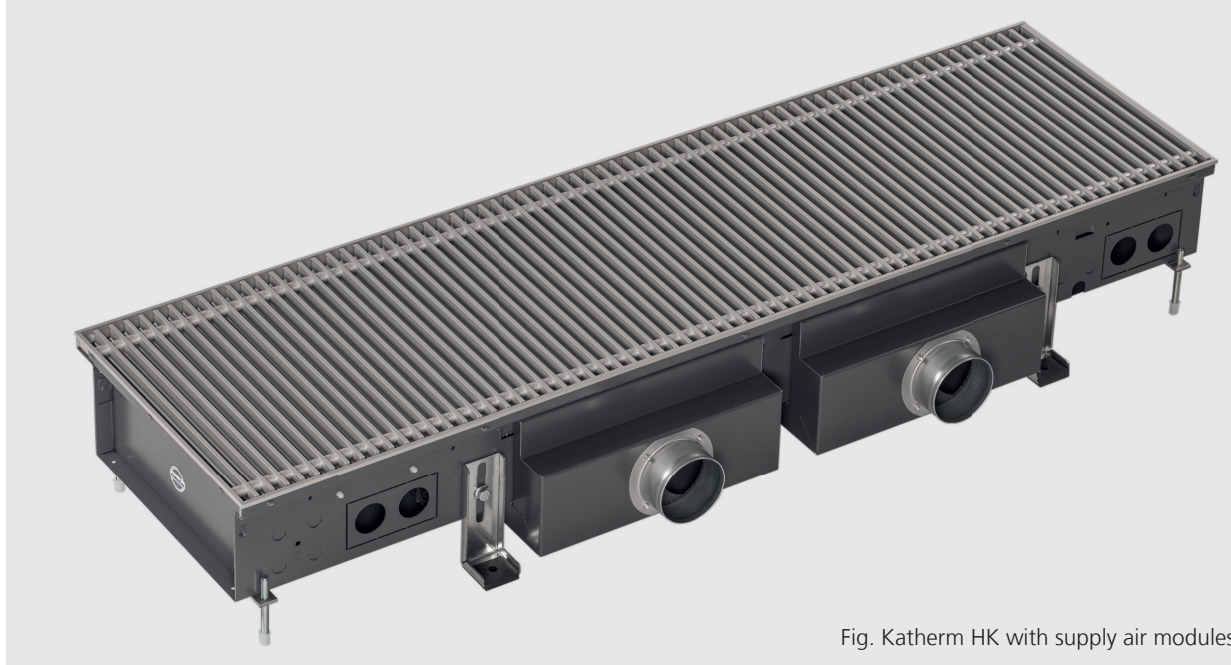

Fig. Katherm HK with supply air modules

Katherm HK units with supply air function are perfectly suited to supply primary air (fresh air) into a space, perfectly combining heating, cooling and a supply of fresh air. There are two versions available: primary air intake via supply air modules or through supply air trenches.

Function of supply air with supply air modules

The conditioned primary air enters through a variable number of supply air modules below the trench heater. It escapes through an outlet slot arranged along the length of the trench heater and mixes with the secondary air heated or cooled by the coil before emerging into the room. Optimum shielding can be provided in front of the glazing with a slow and low-turbulence leaving air velocity. The volume of air supplied can be conveniently adjusted via the variable number of supply air modules per trench and the continuously adjustable slider. Up to 60 m³/h of primary air can be supplied per supply air module. High volumetric flow combined with low slider position can lead to noticeable air flow noises (see adjacent diagram).

The designs of Katherm HK with supply air can be adapted on a project-by-project basis. The trench widths are then +20 mm larger in relation to the standard widths of the Katherm HK versions. The trench heights increase by +35 mm (HK 320) or +20 mm (HK 290 and HK 360). More information on request.

Slider positions¹⁾

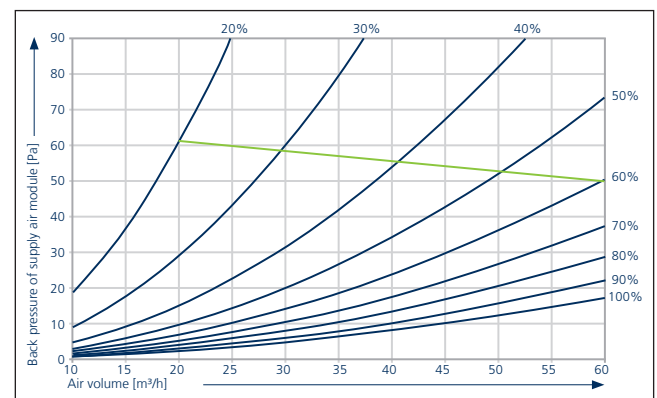

— Slider position
— Limit of perceptible air flow noises

¹⁾ The slider position corresponds to the percentage of the open cross-sectional area of the supply air inlet.

Dimensions: Katherm HK with supply air modules

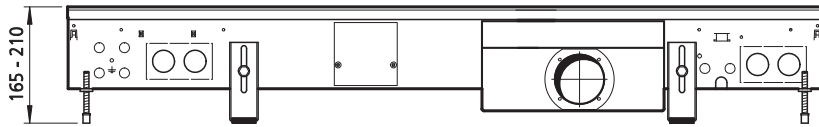

Front view of HK 320 / H 320 E (example shows 1 supply air module)

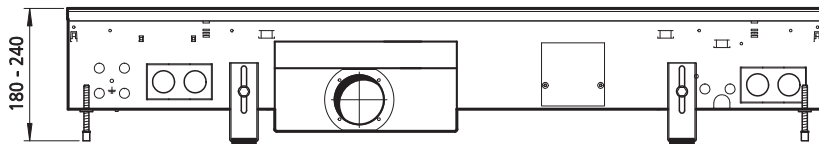

Front view of HK 245 (example shows 2 supply air modules)

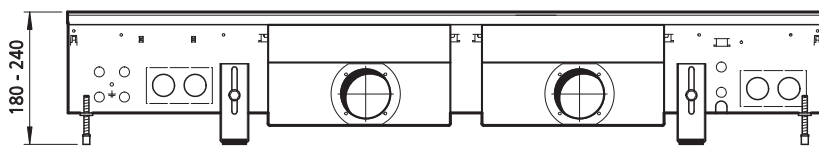

Front view of HK 290 (example shows 2 supply air modules)

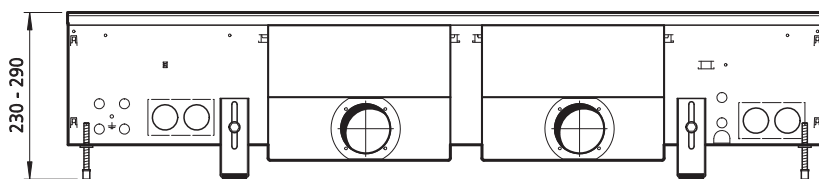

Front view of HK 360 (example shows 2 supply air modules)

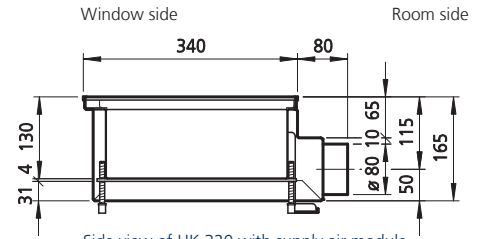

Side view of HK 320 with supply air module

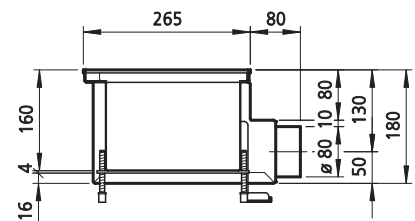

Side view of HK 245 with supply air modules

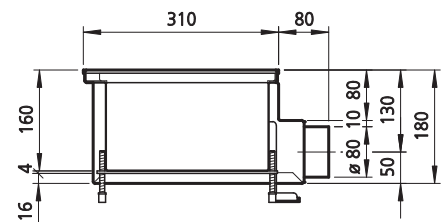

Side view of HK 290 with supply air modules

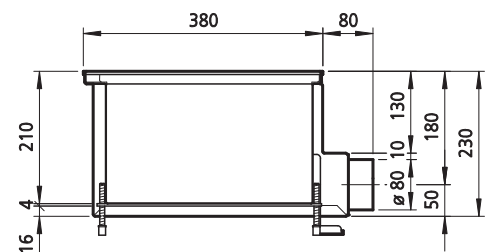

Side view of HK 360 with supply air modules

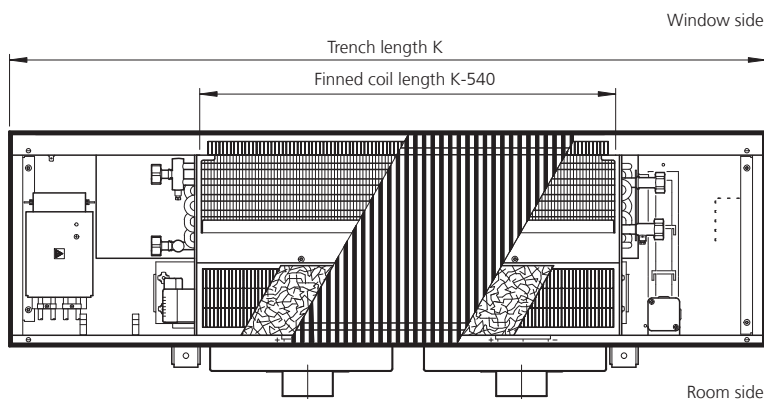

Top view (view without cover panel)

Katherm HK	Trench length [mm]	Max. number of supply air modules
HK 320 HK 290 HK 245	915 / 950*	1
	1200	2
	1700	3
	2000	4
	2500	5
	3000	6
HK 360	950	1
	1200	2
	1350	2
	1850	3
	2250	4

* with Katherm HK 290

Katherm HK – supply air trenches ZL

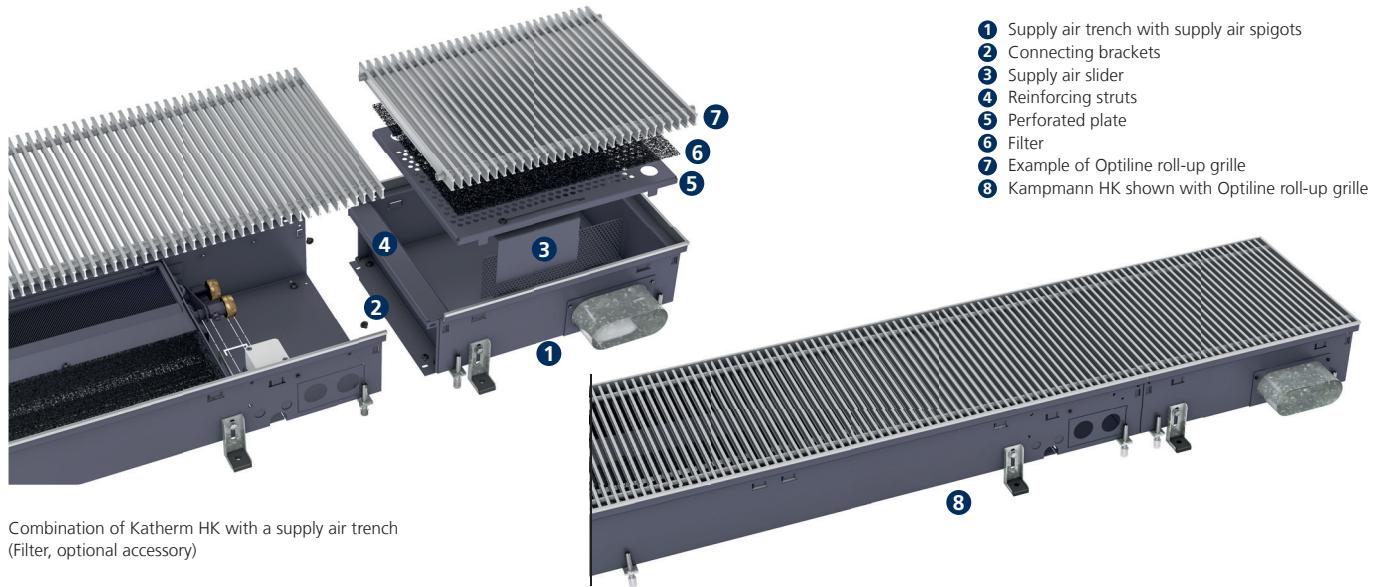

- 1 Supply air trench with supply air spigots
- 2 Connecting brackets
- 3 Supply air slider
- 4 Reinforcing struts
- 5 Perforated plate
- 6 Filter
- 7 Example of Optiline roll-up grille
- 8 Kampmann HK shown with Optiline roll-up grille

Combination of Katherm HK with a supply air trench (Filter, optional accessory)

The Katherm supply air trench ZL is available for all trench heaters (Katherm range). This represents a 400 mm long trench, which can be fitted to all designs of Katherm units. Conditioned supply air can also be fed into rooms through the Katherm supply air trench ZL. This is achieved with different sizes/designs of spigots for the most diverse trench dimensions. It is possible to regulate the air volume flow by means of slider elements built into in the supply air trenches.

Benefits:

- ▶ available for trench widths and heights as per the table in the Katherm range
- ▶ supply air feed through the Katherm floor trench
- ▶ low leaving air speeds, hence pleasant levels of comfort
- ▶ low sound development when correctly designed
- ▶ low investment and maintenance costs
- ▶ supply air outlets visually identical to Katherm trench heaters
- ▶ no wear parts / no electrically rotating parts

Trench width	Trench length	Trench height	Supply air spigot	Max. air volume flow (noiseless)
[mm]	[mm]	[mm]	[mm]	[m³/h]
320	400	130	oval 51x128	70
245	400	160	DN 80	60
290	400	160	DN 80	60
360	400	210	DN 100	85

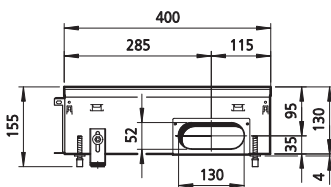

Supply air trench, oval, for Katherm HK 320/130

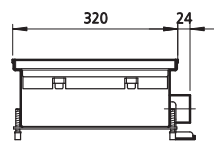

Side view

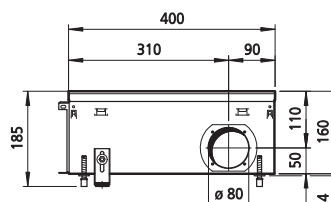

Supply air trench DN 80, for Katherm HK 245/160

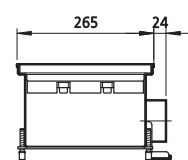

Side view

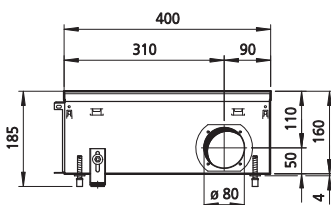

Supply air trench DN 80, for Katherm HK 290/160

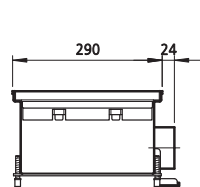

Side view

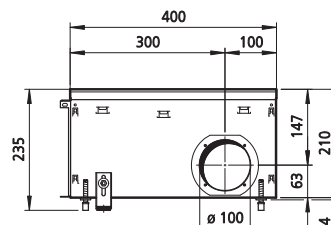

Supply air trench DN 100, for Katherm HK 360/210

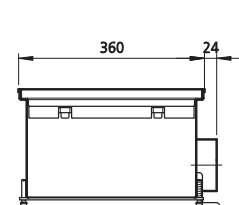

Side view

Comfort

Comfort also plays a key role in air conditioning. We'll help you to consider this aspect when designing a project using Kampmann trench heaters, at the same time as complying with the current guidelines in DIN EN 15251 (in future DIN EN 16798 Parts 1 and 2) and DIN EN ISO 7730. Essentially the following recommended values can be assumed:

For heating:
Supply air outlet temperature: 20–26 °C (but not lower than the room temperature)
 Outlet velocity: < 1.5 m/s
 Distance of the supply air trench to the occupied zone: > 0.5 m

For cooling:
Supply air outlet temperature: < 4K below room temperature
 Outlet velocity: < 1.2 m/s
 Distance of the supply air trench to the occupied zone: > 1 m

Other parameters

In individual cases, additional parameters, such as room and supply air humidity, as well as leaving air velocity, need to be taken into consideration. (See DIN EN ISO 7730)

Additional information

The supply air trenches Katherm ZL can be used for cooling, heating or isothermic air exchange using preconditioned primary air. A spigot or connection at the front end is also possible with appropriate trench dimensions and sufficient space in the air outlet area (check on request!).

The upper limit of the air volume flow in the spigot is calculated from the maximum air speed and cross-section of the spigot. This speed should not exceed 3.0 m/s to avoid additional sound emissions. The resulting air-side pressure losses vary according to the air volume flow as per the diagram.

Design diagrams

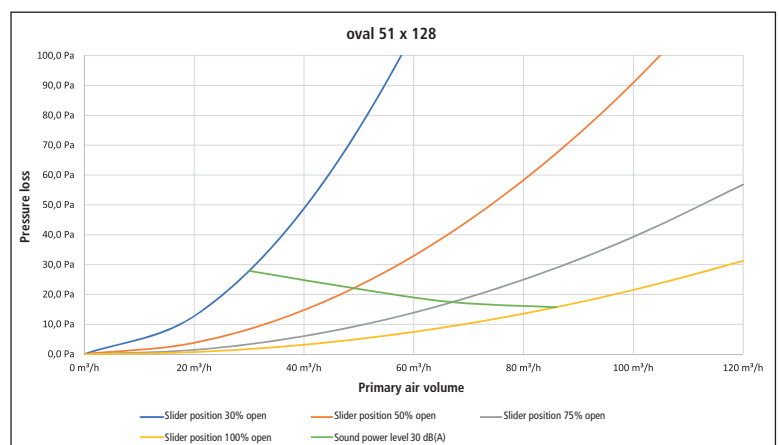
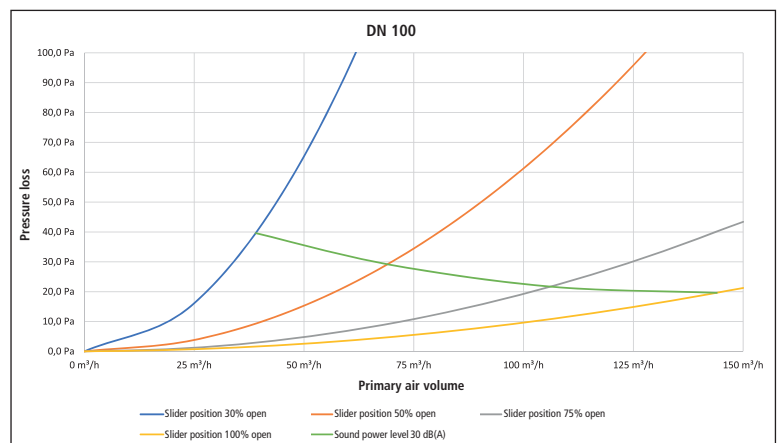
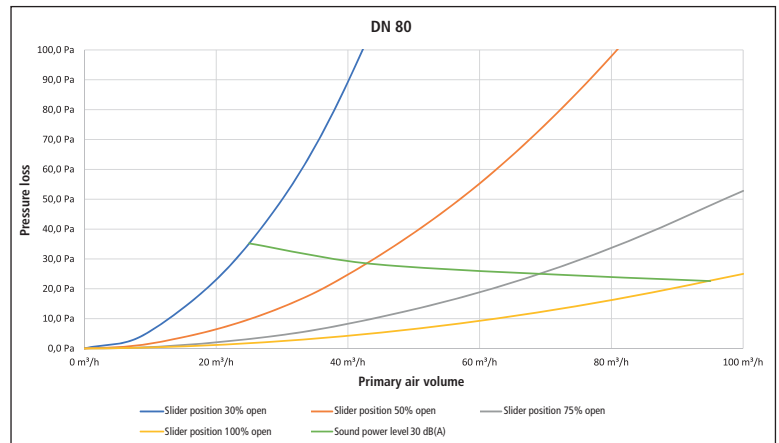

02 ▶ Technical data

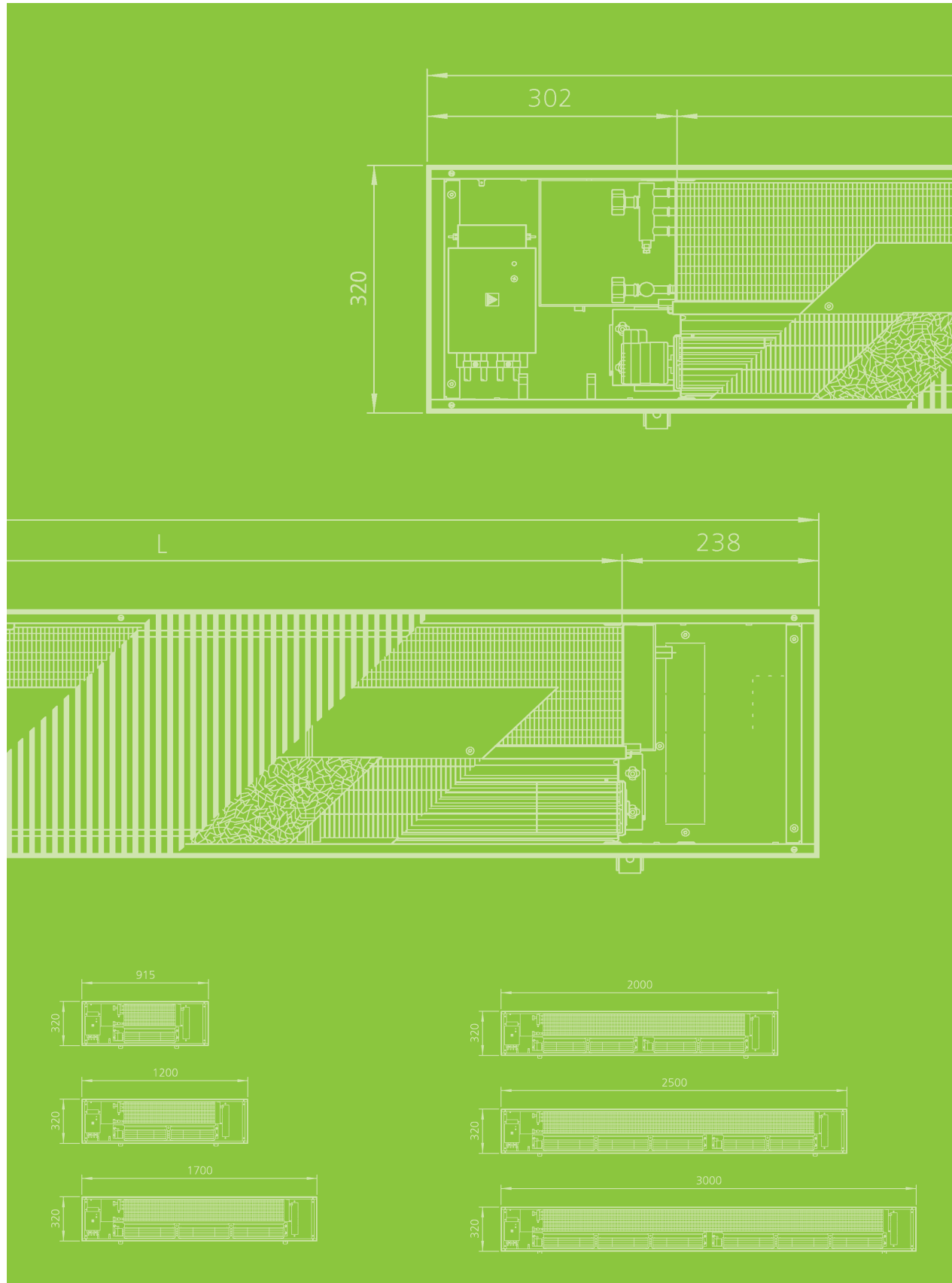

Advice on measuring conditions

Heat and cooling outputs

The heat and cooling outputs were measured in accordance with DIN EN 16430 "Fan-assisted heaters, convectors and trench convectors".

- Part 1 "Technical specifications and requirements"
- Part 2 "Test method and evaluation of the heat output"
- Part 3 "Test method and evaluation of the cooling output"

The standard regulates the performance measurements specifically of trench convectors under normal operating conditions based on DIN EN 442 "Radiators and Convectors".

- Part 1 "Technical specification and requirements"
- Part 2 "Test method and performance data"

The specific requirements for cooling mode are taken into account in DIN EN 16430 Part 3. The reference air temperature is measured in the centre of the test chamber (2 metres from the external wall) at a height of 0.75 metres. This reference air temperature is not to be confused with the air inlet temperature. This may differ significantly between the unavoidable short circuit between the air outlet and air intake.

The heat loads are introduced into the test cabin by 10 output-controlled dummies (see photo) so that they cannot or can only reproducibly influence the outputs and functions.

Katherm HK have been developed and built to be short circuit-optimised. The probability of a short circuit is minimised as far as is technically possible.

Katherm HK E, safety functions and heat outputs

The safety functions and the heat outputs have been measured under consideration of the following standards:

- ▶ DIN EN 60335 Safety of electrical appliances for domestic use and similar purposes
- ▶ Part 1 (VDE 0700-1): General requirements
- ▶ Part 2-30 (VDE 0700-30): Particular requirements for room heaters
- ▶ Part 2-40 (VDE 0700-40): Particular requirements for electrical heat pumps, air conditioners and dehumidifiers

Acoustics

Katherm HK are very often used in acoustically sensitive areas. Accordingly, Katherm HK have been optimised in terms of noise levels. The sound power level is measured in accordance with DIN EN ISO 3744. (Determination of the sound power and sound energy levels of sources of sound from sound pressure measurements – precision 2 class of enveloping measurement surface for an essentially free sound field over a reflective plane) in a semi-low reflective acoustic measuring chamber.

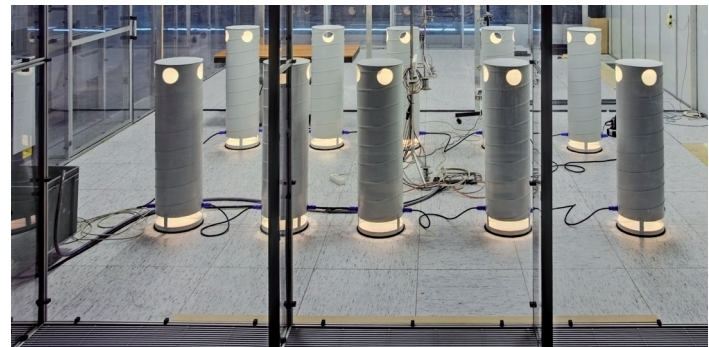

Heat and cooling output test cabin

Comparison of air flow profiles

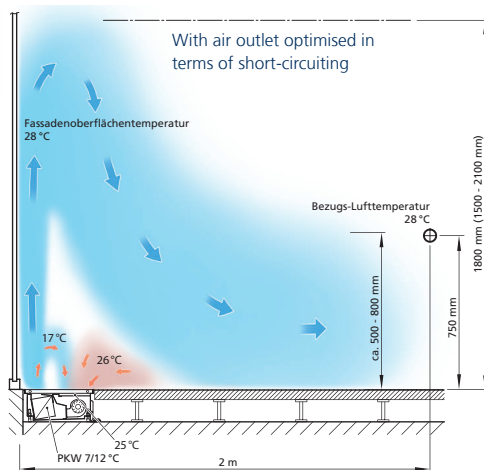
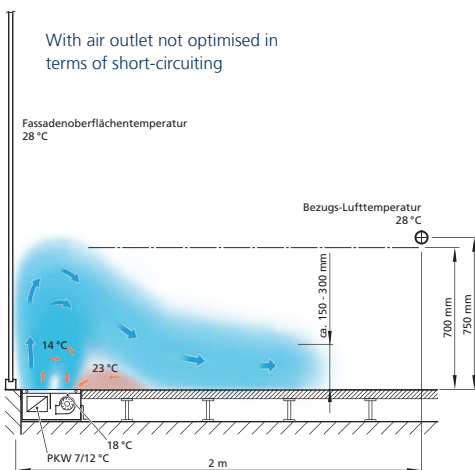

Katherm HK

HK 245

2-pipe

Height 160 mm

Technical drawing (Dimensions in mm)

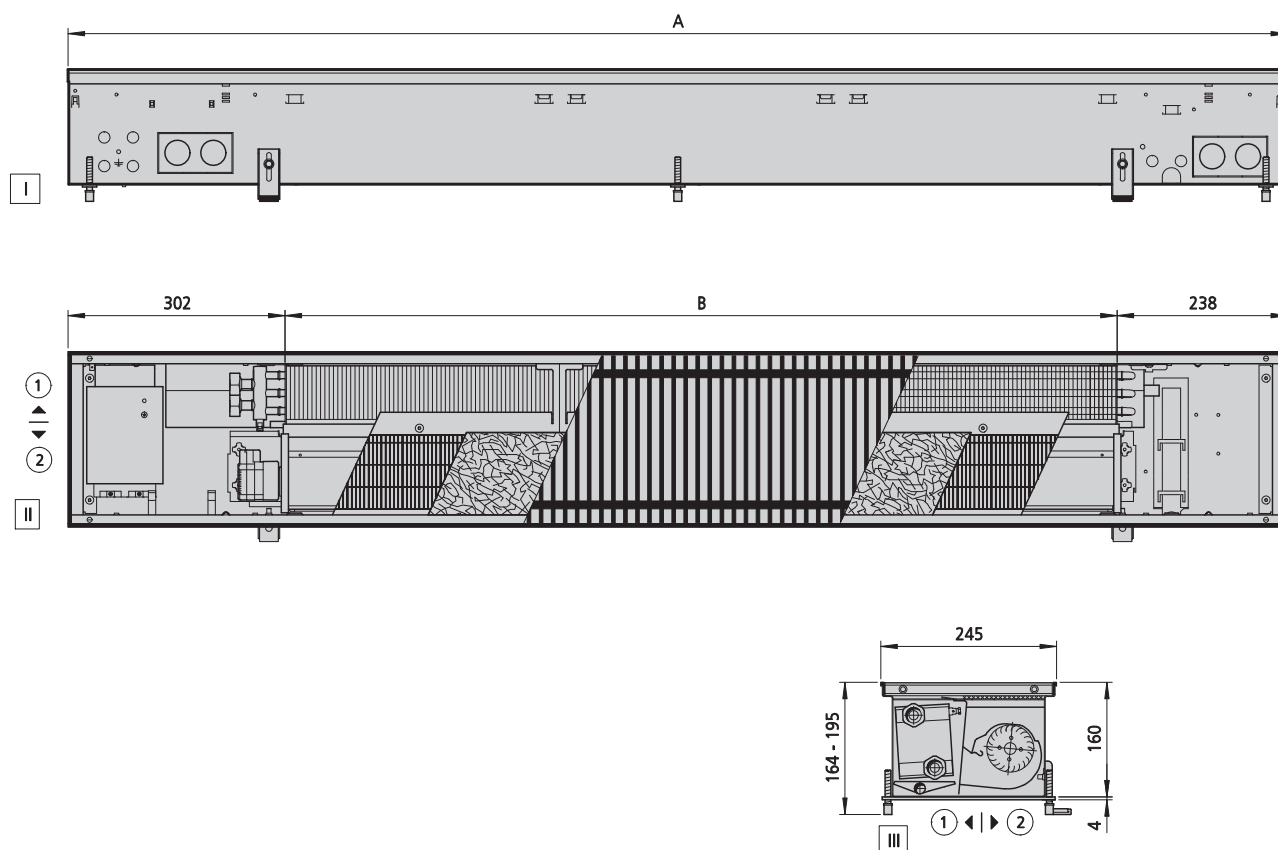

View

- I Front view
- II top view (without cover panel)
- III cross-section

Further information

- ① window side
- ② room side

Specifications

Article no.	Connection	Grille finish	Grille design	Length (A) [mm]	finned length (B) [mm]	Water content [l]	Weight [kg]
143242611113**	Eurokonus, same-end, heating/cooling connection side on left	Aluminium, natural anodised	Roll-up grille	915	375	0.5	17
143242611119**	Eurokonus, same-end, heating/cooling connection side on left	Aluminium, natural anodised	Roll-up grille	1200	660	0.8	22
143242611129**	Eurokonus, same-end, heating/cooling connection side on left	Aluminium, natural anodised	Roll-up grille	1700	1160	1.4	31
143242611135**	Eurokonus, same-end, heating/cooling connection side on left	Aluminium, natural anodised	Roll-up grille	2000	1460	1.8	37
143242611145**	Eurokonus, same-end, heating/cooling connection side on left	Aluminium, natural anodised	Roll-up grille	2500	1960	2.4	52
143242611155**	Eurokonus, same-end, heating/cooling connection side on left	Aluminium, natural anodised	Roll-up grille	3000	2460	3	57

Performance data

Length ¹⁾	Control voltage	Heat output		Heat output		Cooling output, total			Cooling output, total			Power consumption ²⁾	Amperage	SFP	Air flow ³⁾	Sound pressure level ⁴⁾	Sound power level
		at LPHW 75/65 °C, $t_{1,1} = 20$ °C	Outlet air temperature	at LPHW 55/45 °C, $t_{1,1} = 20$ °C	Outlet air temperature	at CHW 16/18, $t_{1,1} = 27$ °C, 48% relative humidity			at CHW 7/12 °C, $t_{1,1} = 27$ °C, 48% relative humidity								
[mm]	[V]	[W]	[°C]	[W]	[°C]	[W]	[W]	[°C]	[W]	[W]	[°C]	[W]	[mA]	[Ws/ m ²]	[m ³ /h]	[dB(A)]	[dB(A)]
915	10	1452	53.6	906	43.5	251	251	19.0	481	395	13.3	7.9	82	274	104	37	45
	8	1248	55.5	768	44.5	205	205	19.0	396	322	13.1	6.6	68	280	84	32	40
	6	1044	58.5	629	46.0	159	159	19.0	308	248	12.9	5.6	58	309	65	25	33
	4	841	64.0	490	48.8	112	112	19.0	219	174	12.7	5.0	52	391	46	20	28
	2	637	75.0	351	55.0	66	66	19.0	128	101	12.5	4.7	49	612	28	20	28
1200	10	2420	53.6	1511	43.5	419	419	19.0	802	659	13.3	11.3	117	236	173	40	48
	8	2080	55.5	1279	44.5	341	341	19.0	659	536	13.1	8.5	88	218	141	34	42
	6	1740	58.5	1048	46.0	264	264	19.0	514	413	12.9	6.5	67	217	108	27	35
	4	1401	64.0	817	48.8	187	187	19.0	365	291	12.7	5.3	55	252	76	20	28
	2	1061	75.0	586	55.0	110	110	19.0	213	168	12.5	5.0	52	387	46	20	28
1700	10	4355	53.6	2719	43.5	754	754	19.0	1443	1186	13.3	16.7	172	193	311	42	50
	8	3744	55.5	2303	44.5	615	615	19.0	1187	965	13.1	12.6	130	179	253	36	44
	6	3133	58.5	1887	46.0	476	476	19.0	925	744	12.9	9.3	96	172	195	30	38
	4	2522	64.0	1470	48.8	337	337	19.0	657	523	12.7	6.8	70	178	137	22	30
	2	1910	75.0	1054	55.0	198	198	19.0	383	302	12.5	5.1	53	221	83	20	28
2000	10	4839	53.6	3021	43.5	837	837	19.0	1603	1318	13.3	22.7	235	237	345	43	51
	8	4160	55.5	2559	44.5	683	683	19.0	1319	1072	13.1	17.0	176	218	281	37	45
	6	3481	58.5	2096	46.0	529	529	19.0	1027	827	12.9	13.0	135	216	217	30	38
	4	2802	64.0	1634	48.8	374	374	19.0	730	581	12.7	10.7	111	252	152	22	30
	2	2123	75.0	1171	55.0	220	220	19.0	426	336	12.5	10.0	104	388	92	20	28
2500	10	6775	53.6	4230	43.5	1172	1172	19.0	2245	1845	13.3	28.0	290	208	484	44	52
	8	5824	55.5	3582	44.5	956	956	19.0	1846	1501	13.1	21.1	218	193	394	38	46
	6	4873	58.5	2935	46.0	740	740	19.0	1438	1158	12.9	15.8	163	187	303	32	40
	4	3922	64.0	2287	48.8	524	524	19.0	1022	814	12.7	12.1	125	205	213	24	32
	2	2972	75.0	1639	55.0	308	308	19.0	596	470	12.5	10.1	105	281	129	20	28
3000	10	8710	53.6	5438	43.5	1507	1507	19.0	2886	2372	13.3	33.3	345	193	622	45	53
	8	7488	55.5	4606	44.5	1229	1229	19.0	2373	1930	13.1	25.1	260	178	506	39	47
	6	6266	58.5	3773	46.0	951	951	19.0	1849	1488	12.9	18.5	192	171	390	33	41
	4	5043	64.0	2940	48.8	673	673	19.0	1314	1046	12.7	13.5	140	177	274	25	33
	2	3821	75.0	2108	55.0	395	395	19.0	767	605	12.5	10.2	106	220	166	20	28

Use our calculation tools on our website to easily calculate heat outputs and other technical data with just a few clicks!

▶ <https://www.kampmanngroup.com/hvac/products/trench-technology/katherm-hk#Calculate-performance-data>

¹⁾ Versions with roll-up grille, Katherm HK with linear grille are available on request!

²⁾ Add an additional power consumption of 1 W per thermoelectric actuator, art. no. 194000146906.

³⁾ Values rounded up within the measurement tolerances.

⁴⁾ The sound pressure levels were calculated with an assumed room insulation of 8 dB(A). This corresponds to a distance of 2 m, a room volume of 100 m³ and a reverberation time of 0.5 s (in accordance with VDI 2081) Sound pressure level < 20 dB (A) and sound power level < 28 dB (A) outside the usual measuring and audible range.

Katherm HK

HK 245

4-pipe

Height 160 mm

Technical drawing (Dimensions in mm)

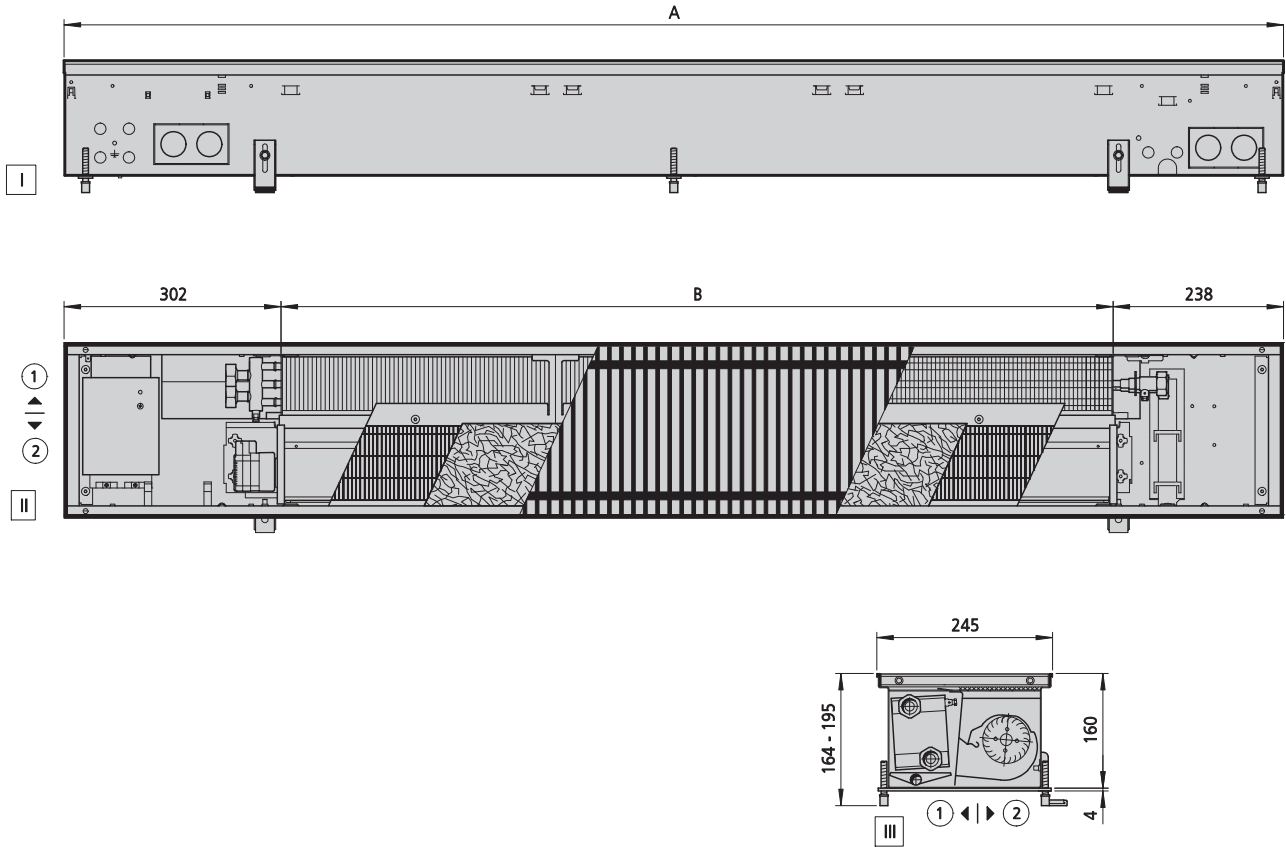

View

- I Front view
- II top view (without cover panel)
- III cross-section

Further information

- ① window side
- ② room side

Specifications

Article no.	Connection	Grille finish	Grille design	Length (A) [mm]	finned length (B) [mm]	Water content [l]	Weight [kg]
143244611113**	EuroKonus, opposite end, cooling connection side on left, heating connection side on right	Aluminium, natural anodised	Roll-up grille	915	375	0.5	17
143244611119**	EuroKonus, opposite end, cooling connection side on left, heating connection side on right	Aluminium, natural anodised	Roll-up grille	1200	660	0.8	22
143244611129**	EuroKonus, opposite end, cooling connection side on left, heating connection side on right	Aluminium, natural anodised	Roll-up grille	1700	1160	1.4	31
143244611135**	EuroKonus, opposite end, cooling connection side on left, heating connection side on right	Aluminium, natural anodised	Roll-up grille	2000	1460	1.8	37
143244611145**	EuroKonus, opposite end, cooling connection side on left, heating connection side on right	Aluminium, natural anodised	Roll-up grille	2500	1960	2.4	52
143244611155**	EuroKonus, opposite end, cooling connection side on left, heating connection side on right	Aluminium, natural anodised	Roll-up grille	3000	2460	3	57

Performance data

Length ¹⁾	Control voltage	Heat output		Heat output		Cooling output, total			Cooling output, total			Power consumption ²⁾	Amperage	SFP	Air flow ³⁾	Sound pressure level ⁴⁾	Sound power level
		at LPHW 75/65 °C, $t_{l,1} = 20$ °C	Outlet air temperature	at LPHW 55/45 °C, $t_{l,1} = 20$ °C	Outlet air temperature	at CHW 16/18, $t_{l,1} = 27$ °C, 48% relative humidity			at CHW 7/12 °C, $t_{l,1} = 27$ °C, 48% relative humidity								
[mm]	[V]	[W]	[°C]	[W]	[°C]	[W]	[W]	[°C]	[W]	[W]	[°C]	[W]	[mA]	[Ws/ m ²]	[m ³ /h]	[dB(A)]	[dB(A)]
915	10	1053	44.3	657	37.1	237	237	18.9	453	372	13.1	7.9	82	274	104	37	45
	8	905	45.7	557	37.8	193	193	18.9	373	303	13.0	6.6	68	280	84	32	40
	6	757	47.9	456	38.9	149	149	18.9	290	234	12.8	5.6	58	309	65	25	33
	4	610	51.9	355	40.9	106	106	18.9	206	164	12.6	5.0	52	391	46	20	28
	2	462	61.9	255	45.9	62	62	18.9	120	95	12.5	4.7	49	643	26	20	28
1200	10	1755	44.3	1095	37.1	394	394	18.9	755	621	13.1	11.3	117	236	173	40	48
	8	1508	45.7	928	37.8	322	322	18.9	621	505	13.0	8.5	88	218	141	34	42
	6	1262	47.9	760	38.9	249	249	18.9	484	389	12.8	6.5	67	217	108	27	35
	4	1016	51.9	592	40.9	176	176	18.9	344	274	12.6	5.3	55	252	76	20	28
	2	770	61.9	425	45.9	103	103	18.9	201	158	12.5	5.0	52	407	44	20	28
1700	10	3158	44.3	1972	37.1	710	710	18.9	1359	1117	13.1	16.7	172	193	311	42	50
	8	2715	45.7	1670	37.8	579	579	18.9	1118	909	13.0	12.6	130	179	253	36	44
	6	2272	47.9	1368	38.9	448	448	18.9	871	701	12.8	9.3	96	172	195	30	38
	4	1829	51.9	1066	40.9	317	317	18.9	619	493	12.6	6.8	70	178	137	22	30
	2	1385	61.9	764	45.9	186	186	18.9	361	285	12.5	5.1	53	232	79	20	28
2000	10	3509	44.3	2191	37.1	789	789	18.9	1510	1241	13.1	22.7	235	237	345	43	51
	8	3017	45.7	1855	37.8	643	643	18.9	1242	1010	13.0	17.0	176	218	281	37	45
	6	2524	47.9	1520	38.9	498	498	18.9	968	779	12.8	13.0	135	216	217	30	38
	4	2032	51.9	1185	40.9	352	352	18.9	687	548	12.6	10.7	111	252	152	22	30
	2	1539	61.9	849	45.9	207	207	18.9	401	316	12.5	10.0	104	408	88	20	28
2500	10	4913	44.3	3067	37.1	1104	1104	18.9	2114	1738	13.1	28.0	290	208	484	44	52
	8	4223	45.7	2598	37.8	901	901	18.9	1739	1414	13.0	21.1	218	193	394	38	46
	6	3534	47.9	2128	38.9	697	697	18.9	1355	1090	12.8	15.8	163	187	303	32	40
	4	2844	51.9	1658	40.9	493	493	18.9	962	767	12.6	12.1	125	205	213	24	32
	2	2155	61.9	1189	45.9	290	290	18.9	562	443	12.5	10.1	105	295	123	20	28
3000	10	6316	44.3	3944	37.1	1420	1420	18.9	2718	2234	13.1	33.3	345	193	622	45	53
	8	5430	45.7	3340	37.8	1158	1158	18.9	2235	1818	13.0	25.1	260	178	506	39	47
	6	4544	47.9	2736	38.9	896	896	18.9	1742	1402	12.8	18.5	192	171	390	33	41
	4	3657	51.9	2132	40.9	634	634	18.9	1237	986	12.6	13.5	140	177	274	25	33
	2	2771	61.9	1529	45.9	372	372	18.9	722	569	12.5	10.2	106	231	159	20	28

Use our calculation tools on our website to easily calculate heat outputs and other technical data with just a few clicks!

▶ <https://www.kampmanngroup.com/hvac/products/trench-technology/katherm-hk#Calculate-performance-data>

¹⁾ Versions with roll-up grille, Katherm HK with linear grille are available on request!

²⁾ Add an additional power consumption of 1 W per thermoelectric actuator, art. no. 194000146906.

³⁾ Values rounded up within the measurement tolerances.

⁴⁾ The sound pressure levels were calculated with an assumed room insulation of 8 dB(A). This corresponds to a distance of 2 m, a room volume of 100 m³ and a reverberation time of 0.5 s (in accordance with VDI 2081) Sound pressure level < 20 dB (A) and sound power level < 28 dB (A) outside the usual measuring and audible range.

Katherm HK

HK 290

2-pipe

Height 160 mm

Technical drawing (Dimensions in mm)

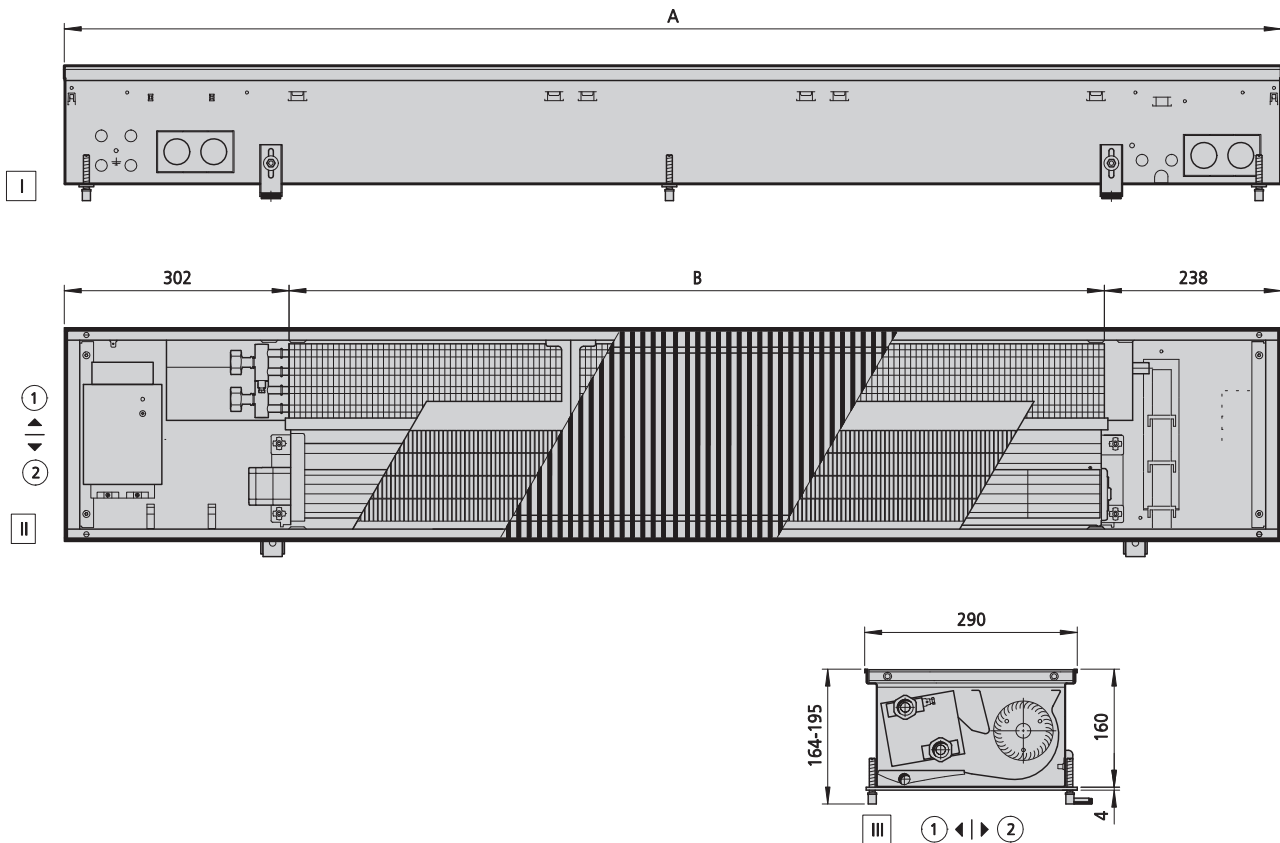

View

- I Front view
- II top view (without cover panel)
- III cross-section

Further information

- ① window side
- ② room side

Specifications

Article no.	Connection	Grille finish	Grille design	Length (A) [mm]	finned length (B) [mm]	Water content [l]	Weight [kg]
143292611114**	Eurokonus, same-end, heating/cooling connection side on left	Aluminium, natural anodised	Roll-up grille	950	410	0.5	21
143292611119**	Eurokonus, same-end, heating/cooling connection side on left	Aluminium, natural anodised	Roll-up grille	1200	660	0.9	28
143292611129**	Eurokonus, same-end, heating/cooling connection side on left	Aluminium, natural anodised	Roll-up grille	1700	1160	1.3	41
143292611135**	Eurokonus, same-end, heating/cooling connection side on left	Aluminium, natural anodised	Roll-up grille	2000	1460	1.7	48
143292611145**	Eurokonus, same-end, heating/cooling connection side on left	Aluminium, natural anodised	Roll-up grille	2500	1960	2.2	62
143292611155**	Eurokonus, same-end, heating/cooling connection side on left	Aluminium, natural anodised	Roll-up grille	3000	2460	2.8	74

Performance data

Length ¹⁾	Control voltage	Heat output		Heat output		Cooling output, total			Cooling output, total			Power consumption ²⁾	Amperage	SFP	Air flow ³⁾	Sound pressure level ⁴⁾	Sound power level
		at LPHW 75/65 °C, t _{1,1} = 20 °C	Outlet air temperature	at LPHW 55/45 °C, t _{1,1} = 20 °C	Outlet air temperature	at CHW 16/18, t _{1,1} =27 °C, 48% relative humidity	Cooling output, sensitive	Outlet air temperature	at CHW 7/12 °C, t _{1,1} = 27 °C, 48% relative humidity	Cooling output, sensitive	Outlet air temperature						
[mm]	[V]	[W]	[°C]	[W]	[°C]	[W]	[W]	[°C]	[W]	[W]	[°C]	[W]	[mA]	[Ws/ m ²]	[m ³ /h]	[dB(A)]	[dB(A)]
950	10	3286	52.4	1941	41.5	486	486	20.4	979	806	15.8	13.4	118	199	243	38	46
	8	2818	55.6	1661	43.6	390	390	20.1	796	647	15.1	11.3	104	216	190	31	39
	6	2247	60.2	1323	46.6	285	285	19.8	591	474	14.4	9.1	89	245	134	22	30
	4	1618	65.4	951	50.0	190	190	19.6	398	315	13.7	6.7	73	284	85	20	28
	2	1057	68.7	618	51.9	114	114	19.4	233	183	13.2	4.2	56	290	52	20	28
1200	10	4851	48.9	2891	39.3	801	801	20.4	1608	1323	15.8	19.2	156	172	402	40	48
	8	4096	51.2	2427	40.8	636	636	20.1	1290	1049	15.0	12.7	113	146	314	34	42
	6	3243	55.0	1909	43.1	452	452	19.7	926	743	14.2	8.1	83	132	222	25	33
	4	2370	60.1	1388	46.4	283	283	19.5	586	465	13.5	5.5	65	140	142	20	28
	2	1599	64.4	931	49.0	165	165	19.3	339	266	13.0	4.8	60	199	86	20	28
1700	10	7262	47.0	4389	38.3	1284	1284	20.4	2576	2120	15.7	29.1	223	162	645	42	50
	8	5877	48.0	3546	38.9	1019	1019	20.1	2063	1678	15.0	19.0	155	136	504	36	44
	6	4302	49.0	2588	39.6	718	718	19.7	1465	1176	14.2	11.8	107	119	356	27	35
	4	2791	49.5	1668	39.8	428	428	19.4	875	693	13.4	7.5	79	119	227	20	28
	2	1657	48.7	978	39.0	212	212	19.2	422	332	12.8	6.2	71	162	138	20	28
2000	10	9420	47.0	5693	38.3	1665	1665	20.4	3341	2750	15.7	35.2	263	151	836	43	51
	8	7622	48.0	4599	38.9	1321	1321	20.1	2676	2176	15.0	22.3	178	123	653	37	45
	6	5580	49.0	3356	39.6	931	931	19.7	1900	1525	14.2	13.2	117	103	462	28	36
	4	3620	49.5	2163	39.8	556	556	19.4	1135	899	13.4	7.9	81	96	294	20	28
	2	2149	48.7	1268	39.0	275	275	19.2	548	430	12.8	6.3	70	126	179	20	28
2500	10	12055	46.8	7305	38.2	2148	2148	20.4	4311	3547	15.7	46.5	338	155	1079	44	52
	8	9651	47.4	5852	38.7	1705	1705	20.1	3452	2808	15.0	28.7	220	122	843	38	46
	6	6866	47.6	4166	38.8	1200	1200	19.7	2450	1966	14.2	16.3	137	98	596	29	37
	4	4186	46.4	2531	37.9	713	713	19.4	1451	1150	13.4	9.4	91	89	380	20	28
	2	2283	43.6	1360	35.8	333	333	19.1	654	514	12.7	7.9	81	123	231	20	28
3000	10	15715	46.9	9505	38.3	2783	2783	20.4	5586	4597	15.7	52.9	409	136	1398	45	53
	8	12661	47.8	7656	38.9	2209	2209	20.1	4474	3638	15.0	32.3	283	106	1092	39	47
	6	9122	48.3	5517	39.2	1556	1556	19.7	3176	2549	14.2	17.9	183	84	772	30	38
	4	5643	47.5	3406	38.6	928	928	19.4	1893	1500	13.4	9.8	111	71	492	21	29
	2	3085	44.7	1839	36.5	444	444	19.1	877	688	12.8	7.9	65	94	300	20	28

Use our calculation tools on our website to easily calculate heat outputs and other technical data with just a few clicks!

▶ <https://www.kampmanngroup.com/hvac/products/trench-technology/katherm-hk#Calculate-performance-data>

¹⁾ Versions with roll-up grille, Katherm HK with linear grille are available on request!

²⁾ Add an additional power consumption of 1 W per thermoelectric actuator, art. no. 194000146906.

³⁾ Values rounded up within the measurement tolerances.

⁴⁾ The sound pressure levels were calculated with an assumed room insulation of 8 dB(A). This corresponds to a distance of 2 m, a room volume of 100 m³ and a reverberation time of 0.5 s (in accordance with VDI 2081) Sound pressure level < 20 dB (A) and sound power level < 28 dB (A) outside the usual measuring and audible range.

Katherm HK

HK 290

4-pipe

Height 160 mm

Technical drawing (Dimensions in mm)

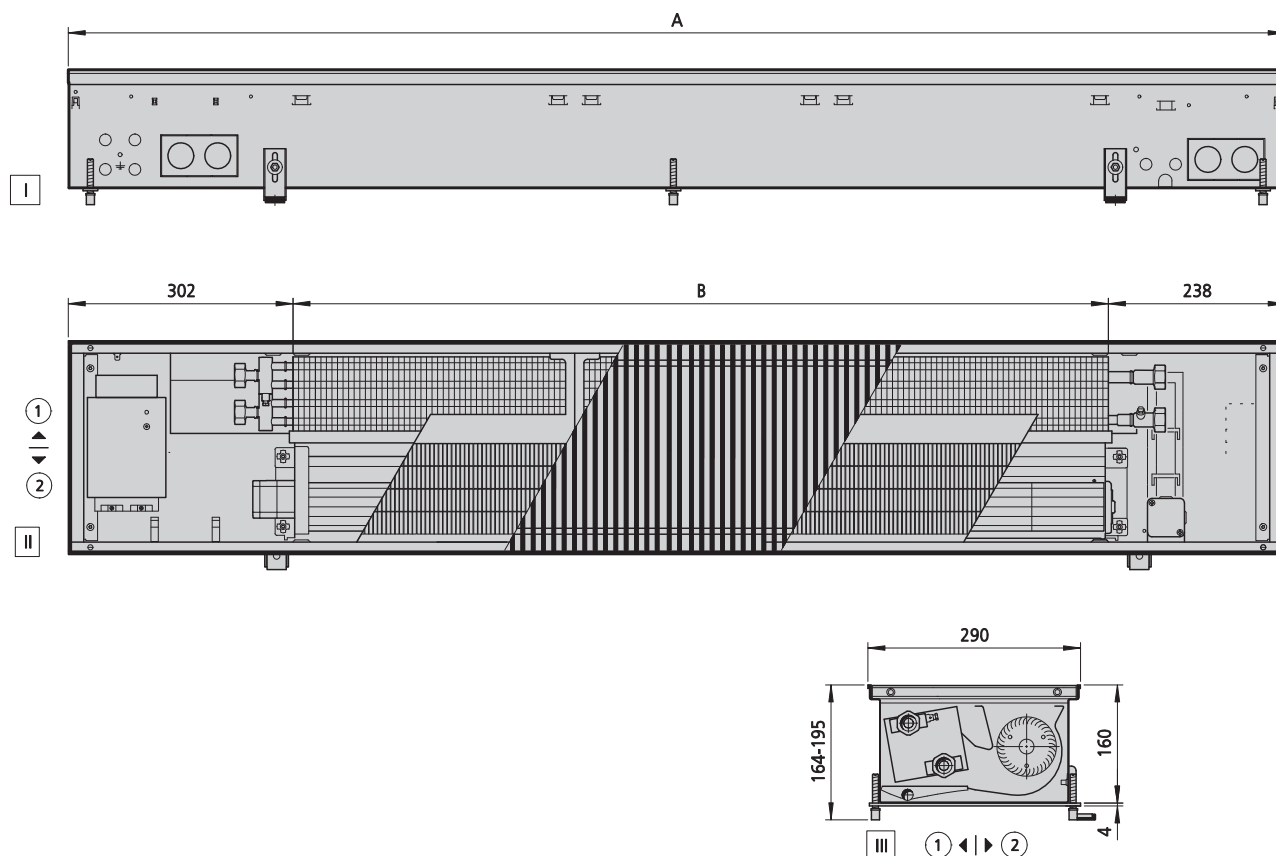

View

- I Front view
- II top view (without cover panel)
- III cross-section

Further information

- ① window side
- ② room side

Specifications

Article no.	Connection	Grille finish	Grille design	Length (A) [mm]	finned length (B) [mm]	Water content [l]	Weight [kg]
143294611114**	EuroKonus, opposite end, cooling connection side on left, heating connection side on right	Aluminium, natural anodised	Roll-up grille	950	410	0.1	22
143294611119**	EuroKonus, opposite end, cooling connection side on left, heating connection side on right	Aluminium, natural anodised	Roll-up grille	1200	660	0.2	28
143294611129**	EuroKonus, opposite end, cooling connection side on left, heating connection side on right	Aluminium, natural anodised	Roll-up grille	1700	1160	0.3	41
143294611135**	EuroKonus, opposite end, cooling connection side on left, heating connection side on right	Aluminium, natural anodised	Roll-up grille	2000	1460	0.4	49
143294611145**	EuroKonus, opposite end, cooling connection side on left, heating connection side on right	Aluminium, natural anodised	Roll-up grille	2500	1960	0.5	62
143294611155**	EuroKonus, opposite end, cooling connection side on left, heating connection side on right	Aluminium, natural anodised	Roll-up grille	3000	2460	0.6	75

Performance data

Length ¹⁾	Control voltage	Heat output		Heat output		Cooling output, total			Cooling output, total			Power consumption ²⁾	Amperage	SFP	Air flow ³⁾	Sound pressure level ⁴⁾	Sound power level
		at LPHW 75/65 °C, t _{1,1} = 20 °C	Outlet air temperature	at LPHW 55/45 °C, t _{1,1} = 20 °C	Outlet air temperature	at CHW 16/18, t _{1,1} =27 °C, 48% relative humidity	Cooling output, sensitive	Outlet air temperature	at CHW 7/12 °C, t _{1,1} =	Cooling output, sensitive	Outlet air temperature						
[mm]	[V]	[W]	[°C]	[W]	[°C]	[W]	[W]	[°C]	[W]	[W]	[°C]	[W]	[mA]	[Ws/ m ²]	[m ³ /h]	[dB(A)]	[dB(A)]
950	10	1639	36.2	991	31.0	476	476	20.3	960	790	15.7	13.4	118	199	243	38	46
	8	1327	36.8	800	31.4	383	383	20.1	781	635	15.0	11.3	104	216	190	31	39
	6	1062	39.0	639	32.8	281	281	19.8	581	467	14.3	9.1	89	245	134	22	30
	4	790	42.2	472	34.9	188	188	19.6	392	311	13.7	6.7	73	284	85	20	28
	2	514	43.7	303	35.7	112	112	19.4	230	180	13.2	4.2	56	290	52	20	28
1200	10	2718	36.2	1643	31.0	785	785	20.3	1576	1297	15.6	19.2	156	172	402	40	48
	8	2199	36.8	1327	31.4	624	624	20.0	1264	1028	14.9	12.7	113	146	314	34	42
	6	1760	39.0	1059	32.8	443	443	19.7	908	729	14.2	8.1	83	132	222	25	33
	4	1309	42.2	782	34.9	278	278	19.4	577	457	13.5	5.5	65	140	142	20	28
	2	852	43.7	503	35.7	162	162	19.3	334	262	13.0	4.8	60	199	86	20	28
1700	10	4357	36.2	2633	31.0	1258	1258	20.3	2525	2078	15.6	29.1	223	162	645	42	50
	8	3526	36.8	2127	31.4	998	998	20.0	2022	1644	14.9	19.0	155	136	504	36	44
	6	2822	39.0	1697	32.8	703	703	19.7	1436	1152	14.1	11.8	107	119	356	27	35
	4	2099	42.2	1254	34.9	420	420	19.4	857	679	13.4	7.5	79	119	227	20	28
	2	1366	43.7	806	35.7	207	207	19.1	414	325	12.8	6.2	71	162	138	20	28
2000	10	5652	36.2	3416	31.0	1632	1632	20.3	3275	2695	15.6	35.2	263	151	836	43	51
	8	4573	36.8	2759	31.4	1295	1295	20.0	2623	2133	14.9	22.3	178	123	653	37	45
	6	3661	39.0	2202	32.8	912	912	19.7	1862	1494	14.1	13.2	117	103	462	28	36
	4	2722	42.2	1627	34.9	545	545	19.4	1112	881	13.4	7.9	81	96	294	20	28
	2	1771	43.7	1045	35.7	269	269	19.1	537	421	12.8	6.3	70	126	179	20	28
2500	10	7291	36.2	4406	31.0	2105	2105	20.3	4225	3476	15.6	46.5	338	155	1079	44	52
	8	5900	36.8	3560	31.4	1670	1670	20.0	3384	2751	14.9	28.7	220	122	843	38	46
	6	4723	39.0	2840	32.8	1177	1177	19.7	2402	1928	14.1	16.3	137	98	596	29	37
	4	3512	42.2	2098	34.9	703	703	19.4	1435	1137	13.4	9.4	91	89	380	20	28
	2	2285	43.7	1348	35.7	347	347	19.1	693	544	12.8	7.9	81	123	231	20	28
3000	10	9448	36.2	5710	31.0	2728	2728	20.3	5474	4505	15.6	52.9	409	136	1398	45	53
	8	7646	36.8	4613	31.4	2165	2165	20.0	4385	3566	14.9	32.3	283	106	1092	39	47
	6	6120	39.0	3681	32.8	1525	1525	19.7	3113	2498	14.1	17.9	183	84	772	30	38
	4	4551	42.2	2719	34.9	909	909	19.4	1854	1469	13.3	9.8	111	71	492	21	29
	2	2961	43.7	1747	35.7	435	435	19.1	857	673	12.7	7.9	65	94	300	20	28

Use our calculation tools on our website to easily calculate heat outputs and other technical data with just a few clicks!

▶ <https://www.kampmanngroup.com/hvac/products/trench-technology/katherm-hk#Calculate-performance-data>

¹⁾ Versions with roll-up grille, Katherm HK with linear grille are available on request!

²⁾ Add an additional power consumption of 1 W per thermoelectric actuator, art. no. 194000146906.

³⁾ Values rounded up within the measurement tolerances.

⁴⁾ The sound pressure levels were calculated with an assumed room insulation of 8 dB(A). This corresponds to a distance of 2 m, a room volume of 100 m³ and a reverberation time of 0.5 s (in accordance with VDI 2081) Sound pressure level < 20 dB (A) and sound power level < 28 dB (A) outside the usual measuring and audible range.

Katherm HK

HK 320

2-pipe

Height 130 mm

Technical drawing (Dimensions in mm)

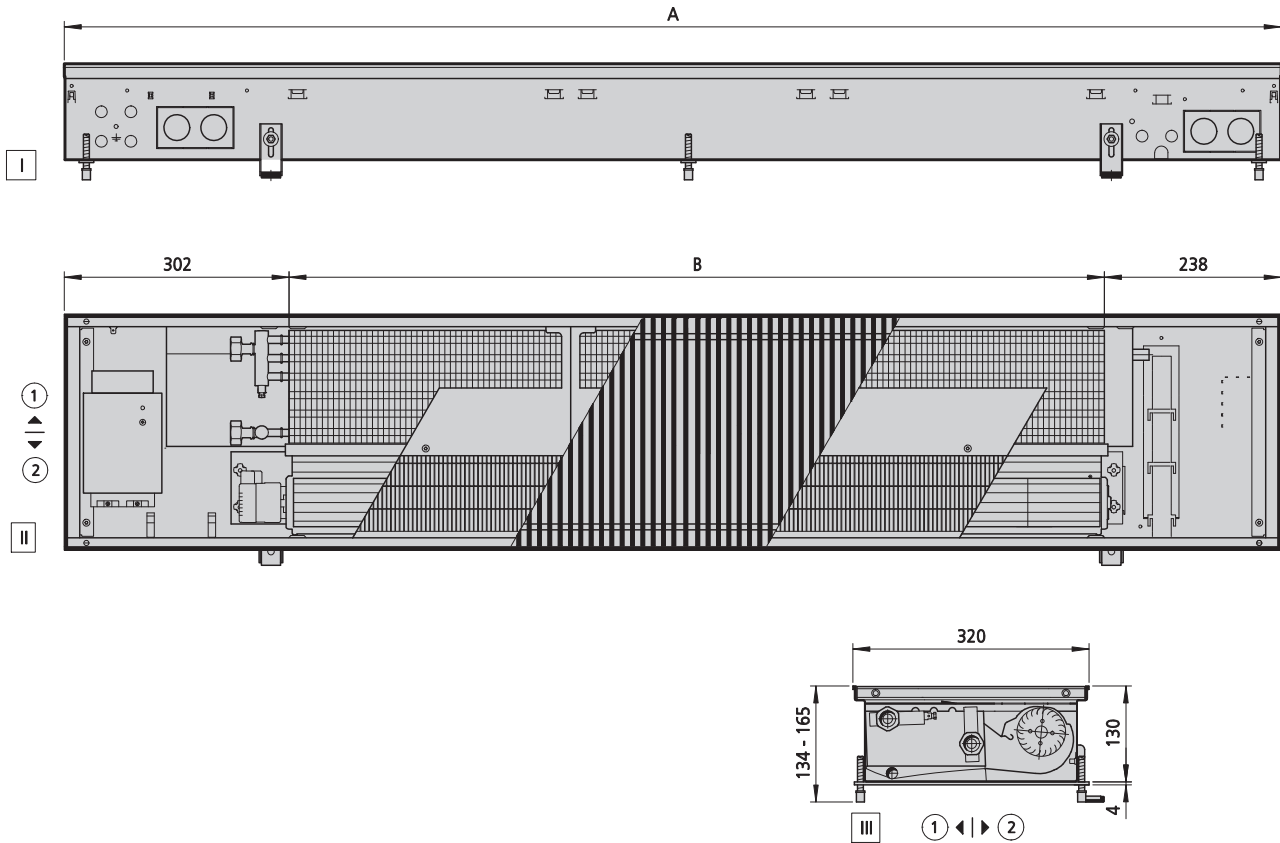

View

- I Front view
- II top view (without cover panel)
- III cross-section

Further information

- ① window side
- ② room side

Specifications

Article no.	Connection	Grille finish	Grille design	Length (A) [mm]	finned length (B) [mm]	Water content [l]	Weight [kg]
143322311113**	Eurokonus, same-end, heating/cooling connection side on left	Aluminium, natural anodised	Roll-up grille	915	375	0.6	18
143322311119**	Eurokonus, same-end, heating/cooling connection side on left	Aluminium, natural anodised	Roll-up grille	1200	660	1	23
143322311129**	Eurokonus, same-end, heating/cooling connection side on left	Aluminium, natural anodised	Roll-up grille	1700	1160	1.8	33
143322311135**	Eurokonus, same-end, heating/cooling connection side on left	Aluminium, natural anodised	Roll-up grille	2000	1460	2.3	40
143322311145**	Eurokonus, same-end, heating/cooling connection side on left	Aluminium, natural anodised	Roll-up grille	2500	1960	3.1	50
143322311155**	Eurokonus, same-end, heating/cooling connection side on left	Aluminium, natural anodised	Roll-up grille	3000	2460	3.9	60

Performance data

Length ¹⁾	Control voltage	Heat output		Heat output		Cooling output, total			Cooling output, total			Power consumption ²⁾	Amperage	SFP	Air flow ³⁾	Sound pressure level ⁴⁾	Sound power level
		at LPHW 75/65 °C, t _{1,1} = 20 °C	Outlet air temperature	at LPHW 55/45 °C, t _{1,1} = 20 °C	Outlet air temperature	at CHW 16/18, t _{1,1} =27 °C, 48% relative humidity	Cooling output, sensitive	Outlet air temperature	at CHW 7/12 °C, t _{1,1} = 27 °C, 48% relative humidity	Cooling output, sensitive	Outlet air temperature						
[mm]	[V]	[W]	[°C]	[W]	[°C]	[W]	[W]	[°C]	[W]	[W]	[°C]	[W]	[mA]	[Ws/ m ²]	[m ³ /h]	[dB(A)]	[dB(A)]
915	10	1764	50.8	1186	43.3	384	384	19.8	868	711	15.6	7.9	82	207	137	33	41
	8	1603	51.7	1096	44.4	349	349	19.6	791	643	15.2	6.6	68	195	121	31	39
	6	1331	54.2	938	47.1	284	284	19.3	642	517	14.4	5.6	58	216	93	24	32
	4	1062	58.9	766	51.5	212	212	18.9	470	374	13.6	5.0	52	273	65	20	28
	2	697	64.4	496	55.0	125	125	18.4	262	206	12.5	4.7	49	451	38	20	28
1200	10	2908	50.5	1801	41.2	571	571	19.5	1259	1030	15.0	11.3	117	179	228	36	44
	8	2630	51.2	1645	41.9	512	512	19.3	1146	932	14.6	8.5	88	152	202	33	41
	6	2149	53.1	1378	43.9	412	412	19.0	937	755	14.0	6.5	67	151	155	26	34
	4	1665	56.6	1111	47.4	310	310	18.7	701	559	13.3	5.3	55	176	109	20	28
	2	1025	59.2	729	51.3	189	189	18.3	407	321	12.5	5.0	52	286	63	20	28
1700	10	5232	50.5	3127	40.5	964	964	19.4	1941	1589	14.4	16.7	172	146	411	38	46
	8	4729	51.2	2817	40.9	845	845	19.1	1708	1390	14.0	12.6	130	125	363	36	44
	6	3853	53.0	2276	41.9	637	637	18.8	1294	1042	13.3	9.3	96	120	280	29	37
	4	2953	56.0	1721	43.6	430	430	18.4	872	694	12.6	6.8	70	125	196	20	28
	2	1696	56.0	964	43.0	223	223	18.1	440	347	11.9	5.1	53	163	113	20	28
2000	10	5814	50.5	3475	40.5	1071	1071	19.4	2157	1766	14.4	22.7	235	179	457	39	47
	8	5255	51.2	3130	40.9	939	939	19.1	1898	1544	14.0	17.0	176	152	404	36	44
	6	4281	53.0	2529	41.9	708	708	18.8	1438	1158	13.3	13.0	135	151	311	29	37
	4	3281	56.0	1913	43.6	478	478	18.4	969	772	12.6	10.7	111	176	218	21	29
	2	1884	56.0	1071	43.0	247	247	18.1	489	385	11.9	10.0	104	286	125	20	28
2500	10	8139	50.5	4855	40.4	1491	1491	19.3	2932	2400	14.2	28.0	290	158	639	40	48
	8	7357	51.2	4366	40.8	1301	1301	19.1	2547	2072	13.8	21.1	218	134	565	38	46
	6	5993	53.0	3505	41.7	964	964	18.7	1862	1499	13.1	15.8	163	131	435	31	39
	4	4592	56.0	2604	42.9	620	620	18.4	1177	938	12.4	12.1	125	143	305	22	30
	2	2612	55.6	1354	40.7	289	289	18.0	535	422	11.8	10.1	105	207	176	20	28
3000	10	10465	50.5	6252	40.5	1925	1925	19.4	3836	3140	14.3	33.3	345	146	822	41	49
	8	9458	51.2	5629	40.9	1685	1685	19.1	3350	2725	13.9	25.1	260	124	726	39	47
	6	7706	53.0	4538	41.8	1260	1260	18.8	2475	1992	13.2	18.5	192	119	559	32	40
	4	5906	56.0	3404	43.3	824	824	18.4	1577	1256	12.5	13.5	140	124	393	23	31
	2	3382	55.9	1807	41.5	387	387	18.0	713	562	11.8	10.2	106	162	226	20	28

Use our calculation tools on our website to easily calculate heat outputs and other technical data with just a few clicks!

▶ <https://www.kampmanngroup.com/hvac/products/trench-technology/katherm-hk#Calculate-performance-data>

¹⁾ Versions with roll-up grille, Katherm HK with linear grille are available on request!

²⁾ Add an additional power consumption of 1 W per thermoelectric actuator, art. no. 194000146906.

³⁾ Values rounded up within the measurement tolerances.

⁴⁾ The sound pressure levels were calculated with an assumed room insulation of 8 dB(A). This corresponds to a distance of 2 m, a room volume of 100 m³ and a reverberation time of 0.5 s (in accordance with VDI 2081) Sound pressure level < 20 dB (A) and sound power level < 28 dB (A) outside the usual measuring and audible range.

Katherm HK

HK 320

4-pipe

Height 130 mm

Technical drawing (Dimensions in mm)

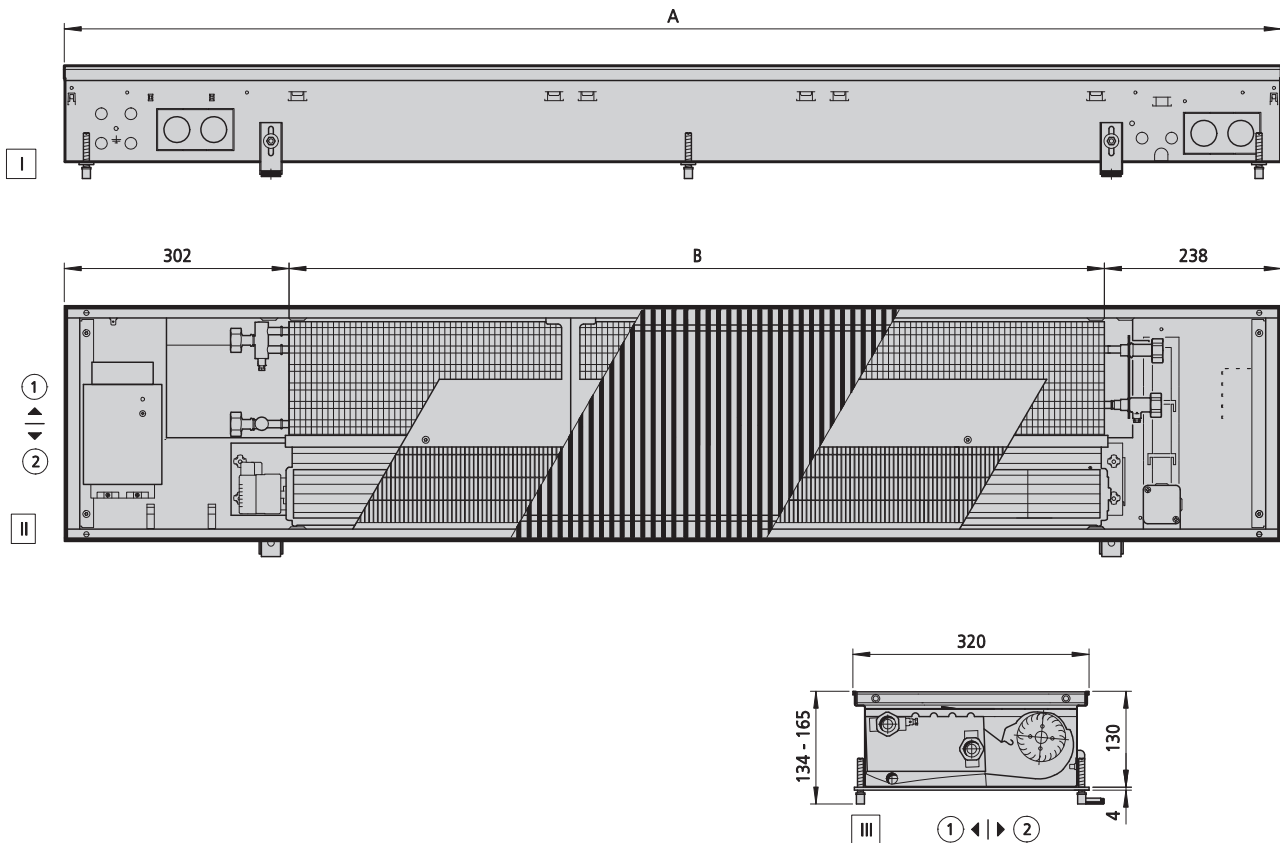

View

- I Front view
- II top view (without cover panel)
- III cross-section

Further information

- ① window side
- ② room side

Specifications

Article no.	Connection	Grille finish	Grille design	Length (A) [mm]	finned length (B) [mm]	Water content [l]	Weight [kg]
143324311113**	EuroKonus, opposite end, cooling connection side on left, heating connection side on right	Aluminium, natural anodised	Roll-up grille	915	375	0.6	18
143324311119**	EuroKonus, opposite end, cooling connection side on left, heating connection side on right	Aluminium, natural anodised	Roll-up grille	1200	660	1	24
143324311129**	EuroKonus, opposite end, cooling connection side on left, heating connection side on right	Aluminium, natural anodised	Roll-up grille	1700	1160	1.8	34
143324311135**	EuroKonus, opposite end, cooling connection side on left, heating connection side on right	Aluminium, natural anodised	Roll-up grille	2000	1460	2.3	40
143324311145**	EuroKonus, opposite end, cooling connection side on left, heating connection side on right	Aluminium, natural anodised	Roll-up grille	2500	1960	3.1	51
143324311155**	EuroKonus, opposite end, cooling connection side on left, heating connection side on right	Aluminium, natural anodised	Roll-up grille	3000	2460	3.9	61

Performance data

Length ¹⁾	Control voltage	Heat output		Heat output		Cooling output, total			Cooling output, total			Power consumption ²⁾	Amperage	SFP	Air flow ³⁾	Sound pressure level ⁴⁾	Sound power level
		at LPHW 75/65 °C, $t_{1,1} = 20$ °C	Outlet air temperature	at LPHW 55/45 °C, $t_{1,1} = 20$ °C	Outlet air temperature	at CHW 16/18, $t_{1,1} = 27$ °C, 48% relative humidity			at CHW 7/12 °C, $t_{1,1} = 27$ °C, 48% relative humidity								
[mm]	[V]	[W]	[°C]	[W]	[°C]	[W]	[W]	[°C]	[W]	[W]	[°C]	[W]	[mA]	[Ws/ m ²]	[m ³ /h]	[dB(A)]	[dB(A)]
915	10	1085	39.0	649	32.7	373	373	19.7	844	691	15.4	7.9	82	207	137	33	41
	8	981	39.4	584	33.0	339	339	19.5	768	625	15.1	6.6	68	195	121	31	39
	6	799	40.5	472	33.6	276	276	19.2	623	502	14.3	5.6	58	216	93	24	32
	4	617	42.6	360	34.8	206	206	18.9	455	363	13.5	5.0	52	273	65	20	28
	2	436	47.7	248	37.7	121	121	18.4	253	199	12.5	4.7	49	451	38	20	28
1200	10	1809	39.0	1081	32.7	552	552	19.4	1223	1001	14.8	11.3	117	179	228	36	44
	8	1635	39.4	974	33.0	497	497	19.3	1113	906	14.5	8.5	88	152	202	33	41
	6	1332	40.5	787	33.6	401	401	19.0	911	733	13.9	6.5	67	151	155	26	34
	4	1029	42.6	600	34.8	301	301	18.7	681	542	13.2	5.3	55	176	109	20	28
	2	726	47.7	413	37.7	184	184	18.3	394	311	12.4	5.0	52	286	63	20	28
1700	10	3256	39.0	1946	32.7	927	927	19.3	1867	1528	14.2	16.7	172	146	411	38	46
	8	2943	39.4	1753	33.0	812	812	19.1	1642	1336	13.8	12.6	130	125	363	36	44
	6	2398	40.5	1416	33.6	613	613	18.7	1245	1002	13.2	9.3	96	120	280	29	37
	4	1852	42.6	1080	34.8	413	413	18.4	838	668	12.5	6.8	70	125	196	20	28
	2	1307	47.7	743	37.7	214	214	18.0	423	333	11.9	5.1	53	163	113	20	28
2000	10	3618	39.0	2162	32.7	1030	1030	19.3	2074	1698	14.2	22.7	235	179	457	39	47
	8	3270	39.4	1948	33.0	903	903	19.1	1825	1485	13.8	17.0	176	152	404	36	44
	6	2664	40.5	1574	33.6	681	681	18.7	1383	1113	13.2	13.0	135	151	311	29	37
	4	2058	42.6	1199	34.8	459	459	18.4	931	742	12.5	10.7	111	176	218	21	29
	2	1452	47.7	825	37.7	238	238	18.0	470	370	11.9	10.0	104	286	125	20	28
2500	10	5065	39.0	3027	32.7	1442	1442	19.3	2904	2377	14.2	28.0	290	158	639	40	48
	8	4578	39.4	2727	33.0	1264	1264	19.1	2555	2078	13.8	21.1	218	134	565	38	46
	6	3729	40.5	2203	33.6	954	954	18.7	1936	1559	13.2	15.8	163	131	435	31	39
	4	2881	42.6	1679	34.8	643	643	18.4	1304	1039	12.5	12.1	125	143	305	22	30
	2	2033	47.7	1156	37.7	333	333	18.0	658	519	11.9	10.1	105	207	176	20	28
3000	10	6512	39.0	3892	32.7	1851	1851	19.3	3681	3013	14.2	33.3	345	146	822	41	49
	8	5886	39.4	3506	33.0	1619	1619	19.1	3212	2613	13.8	25.1	260	124	726	39	47
	6	4795	40.5	2832	33.6	1209	1209	18.7	2369	1907	13.1	18.5	192	119	559	32	40
	4	3704	42.6	2159	34.8	789	789	18.3	1507	1201	12.4	13.5	140	124	393	23	31
	2	2614	47.7	1486	37.7	370	370	18.0	681	537	11.8	10.2	106	162	226	20	28

Use our calculation tools on our website to easily calculate heat outputs and other technical data with just a few clicks!

▶ <https://www.kampmanngroup.com/hvac/products/trench-technology/katherm-hk#Calculate-performance-data>

¹⁾ Versions with roll-up grille, Katherm HK with linear grille are available on request!

²⁾ Add an additional power consumption of 1 W per thermoelectric actuator, art. no. 194000146906.

³⁾ Values rounded up within the measurement tolerances.

⁴⁾ The sound pressure levels were calculated with an assumed room insulation of 8 dB(A). This corresponds to a distance of 2 m, a room volume of 100 m³ and a reverberation time of 0.5 s (in accordance with VDI 2081) Sound pressure level < 20 dB (A) and sound power level < 28 dB (A) outside the usual measuring and audible range.

Katherm HK

HK 320 E

2-pipe electric heating element

Height 130 mm

Technical drawing (Dimensions in mm)

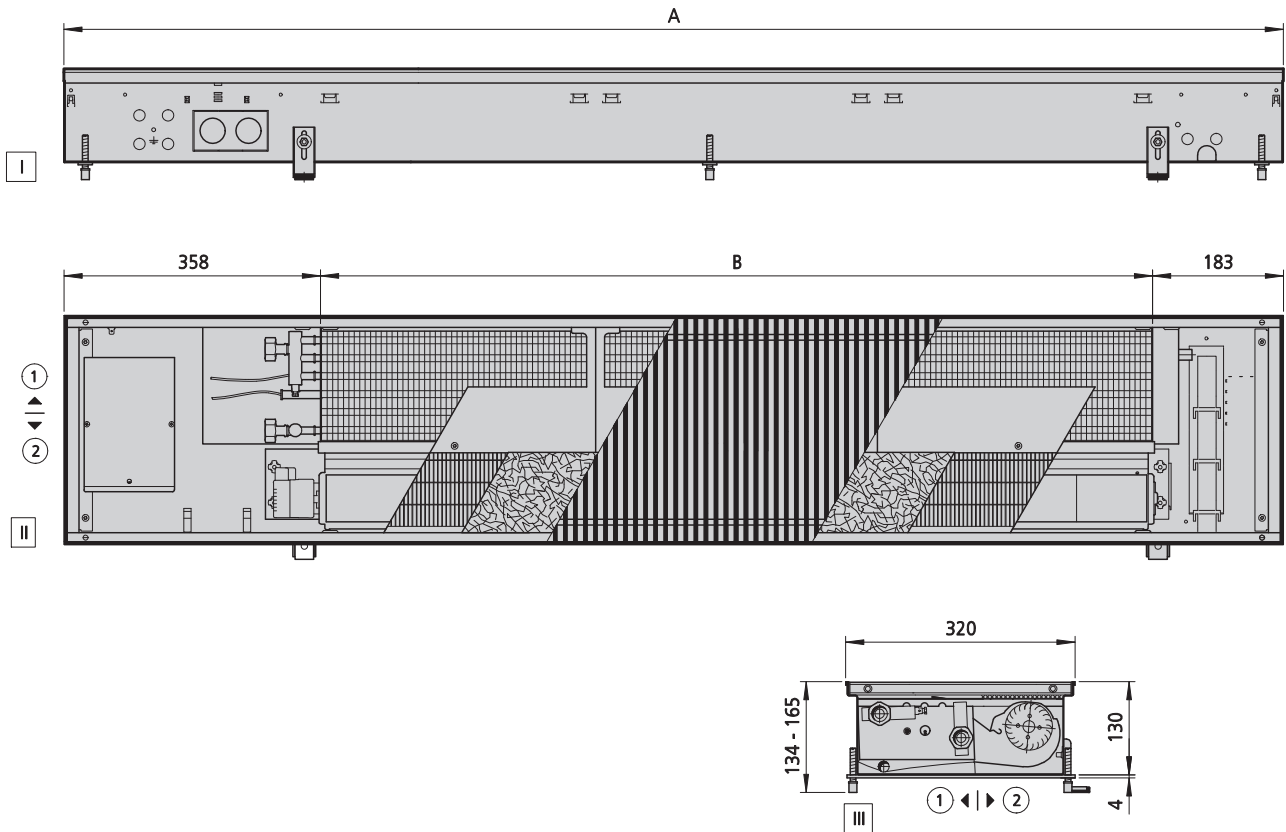

View

- I Front view
- II top view (without cover panel)
- III cross-section

Further information

- ① window side
- ② room side

Specifications

Article no.	Connection	Grille finish	Grille design	Length (A) [mm]	finned length (B) [mm]	Water content [l]	Weight [kg]
143326311113**	Eurokonus, same-end, heating/cooling connection side on left	Aluminium, natural anodised	Roll-up grille	915	375	0.6	18
143326311119**	Eurokonus, same-end, heating/cooling connection side on left	Aluminium, natural anodised	Roll-up grille	1200	660	1	23
143326311129**	Eurokonus, same-end, heating/cooling connection side on left	Aluminium, natural anodised	Roll-up grille	1700	1160	1.6	33
143326311135**	Eurokonus, same-end, heating/cooling connection side on left	Aluminium, natural anodised	Roll-up grille	2000	1460	2	40
143326311145**	Eurokonus, same-end, heating/cooling connection side on left	Aluminium, natural anodised	Roll-up grille	2500	1960	2.8	56
143326311155**	Eurokonus, same-end, heating/cooling connection side on left	Aluminium, natural anodised	Roll-up grille	3000	2460	3.5	60

Performance data

Length ¹⁾	Control voltage	electric heat output		Heat output		Cooling output, total			Cooling output, sensitive			Power consumption ²⁾	Amperage	Amperage when operating with an electric heating element	SFP	Air flow ³⁾	Sound pressure level ⁴⁾	Sound power level
		when operating with an electric heating element	Outlet air temperature	at LPHW 75/65 °C, t _{L1} = 20 °C	Outlet air temperature	at CHW 16/18, t _{L1} = 27 °C, 48% relative humidity	Cooling output, sensitive	Outlet air temperature	at CHW 7/12 °C, t _{L1} = 27 °C, 48% relative humidity	Cooling output, sensitive	Outlet air temperature							
[mm]	[V]	[W]	[°C]	[W]	[°C]	[W]	[W]	[°C]	[W]	[W]	[°C]	[W]	[mA]	[A]	[Ws/m ²]	[m ³ /h]	[dB(A)]	[dB(A)]
915	10	500	47.1	1960	61.1	274	274	19.4	563	460	14.5	7.9	82	2.26	248	114	36	44
	8	500	48.4	1813	63.2	246	246	19.2	507	413	14.2	6.6	68	2.24	234	101	31	39
	6	500	51.3	1551	67.8	198	198	19.0	412	332	13.6	5.6	58	2.23	259	78	24	32
	4	350	55.0	1248	74.8	149	149	18.7	310	247	13.0	5.0	52	1.57	328	55	20	28
	2	200	55.0	767	75.0	91	91	18.3	185	146	12.3	4.7	49	0.92	542	33	20	28
1200	10	1000	42.4	3248	54.1	517	517	19.3	1045	855	14.2	11.3	117	4.47	179	228	38	46
	8	1000	43.5	3012	55.9	454	454	19.1	922	750	13.9	8.5	88	4.43	152	201	33	41
	6	1000	46.1	2601	60.1	350	350	18.8	717	577	13.3	6.5	67	4.41	151	155	26	34
	4	700	50.3	2135	66.9	250	250	18.5	516	411	12.7	5.3	55	3.10	176	109	20	28
	2	400	53.5	1379	72.7	153	153	18.2	312	246	12.1	5.0	52	1.79	286	63	20	28
1700	10	1000	39.3	4933	48.7	927	927	19.3	1867	1528	14.2	16.7	172	4.60	146	411	38	46
	8	1000	39.7	4449	49.4	810	810	19.1	1638	1332	13.8	12.6	130	4.48	125	362	36	44
	6	1000	40.6	3632	51.1	613	613	18.7	1245	1002	13.2	9.3	96	4.44	120	280	29	37
	4	700	42.1	2768	53.8	413	413	18.4	838	668	12.5	6.8	70	3.11	125	196	20	28
	2	400	41.2	1565	53.2	214	214	18.0	423	333	11.9	5.1	53	1.79	163	113	20	28
2000	10	1000	39.3	5481	48.7	1030	1030	19.3	2074	1698	14.2	22.7	235	4.58	179	457	41	49
	8	1000	39.7	4943	49.4	900	900	19.1	1820	1480	13.8	17.0	176	4.52	152	402	36	44
	6	1000	40.6	4036	51.1	681	681	18.7	1383	1113	13.2	13.0	135	4.48	151	311	29	37
	4	700	42.1	3076	53.8	459	459	18.4	931	742	12.5	10.7	111	3.16	176	218	21	29
	2	400	41.2	1739	53.2	238	238	18.0	470	370	11.9	10.0	104	1.84	286	125	20	28
2500	10	1500	38.8	7410	47.8	1442	1442	19.3	2904	2377	14.2	28.0	290	6.81	158	639	41	49
	8	1500	38.9	6609	48.1	1260	1260	19.1	2547	2072	13.8	21.1	218	6.75	135	563	38	46
	6	1500	39.4	5256	48.9	952	952	18.7	1932	1555	13.2	15.8	163	6.68	131	435	31	39
	4	1050	39.9	3841	50.1	637	637	18.4	1286	1024	12.5	12.1	125	4.69	143	305	22	30
	2	600	37.3	1980	47.0	310	310	18.0	603	475	11.8	10.1	105	2.71	207	176	20	28
3000	10	1500	39.1	9716	48.3	1854	1854	19.3	3734	3056	14.2	33.3	345	6.86	146	822	41	49
	8	1500	39.3	8703	48.8	1620	1620	19.1	3275	2664	13.8	25.1	260	6.80	125	724	39	47
	6	1500	39.9	6975	49.9	1226	1226	18.7	2488	2003	13.2	18.5	192	6.71	119	559	32	40
	4	1050	40.7	5135	51.3	825	825	18.4	1669	1329	12.5	13.5	140	4.70	124	393	23	31
	2	600	38.0	2649	48.1	411	411	18.0	802	633	11.9	10.2	106	2.72	162	226	20	28

Use our calculation tools on our website to easily calculate heat outputs and other technical data with just a few clicks!

▶ <https://www.kampmanngroup.com/hvac/products/trench-technology/katherm-hk#Calculate-performance-data>

¹⁾ Versions with roll-up grille, Katherm HK with linear grille are available on request!

²⁾ Add an additional power consumption of 1 W per thermoelectric actuator, art. no. 194000146906.

³⁾ Values rounded up within the measurement tolerances.

⁴⁾ The sound pressure levels were calculated with an assumed room insulation of 8 dB(A). This corresponds to a distance of 2 m, a room volume of 100 m³ and a reverberation time of 0.5 s (in accordance with VDI 2081) Sound pressure level < 20 dB (A) and sound power level < 28 dB (A) outside the usual measuring and audible range.

Katherm HK

HK 360

2-pipe

Height 210 mm

Technical drawing (Dimensions in mm)

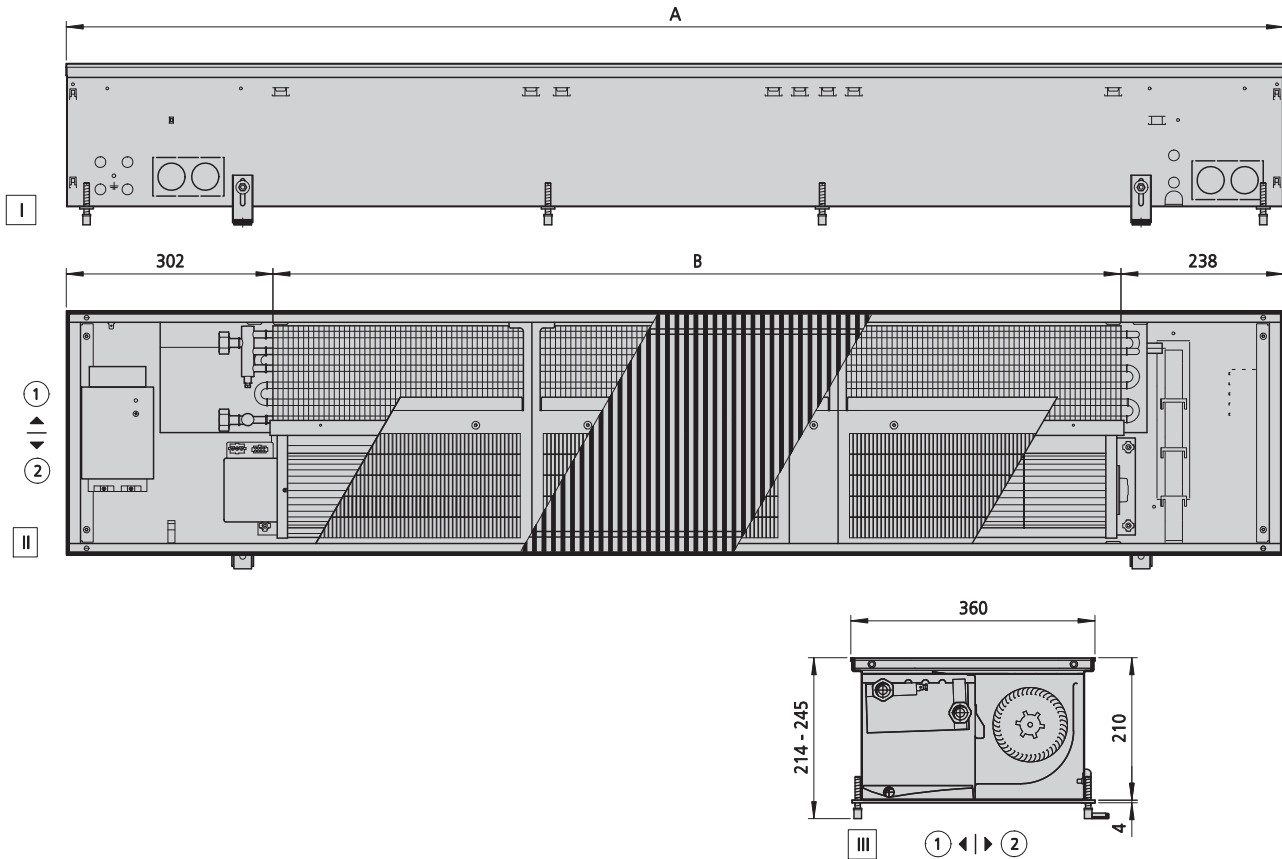

View

- I Front view
- II top view (without cover panel)
- III cross-section

Further information

- ① window side
- ② room side

Specifications

Article no.	Connection	Grille finish	Grille design	Length (A) [mm]	finned length (B) [mm]	Water content [l]	Weight [kg]
143362211114**	Eurokonus, same-end, heating/cooling connection side on left	Aluminium, natural anodised	Roll-up grille	950	410	0.6	25
143362211119**	Eurokonus, same-end, heating/cooling connection side on left	Aluminium, natural anodised	Roll-up grille	1200	660	0.9	32
143362211122**	Eurokonus, same-end, heating/cooling connection side on left	Aluminium, natural anodised	Roll-up grille	1350	810	1.1	36
143362211132**	Eurokonus, same-end, heating/cooling connection side on left	Aluminium, natural anodised	Roll-up grille	1850	1310	1.9	49
143362211140**	Eurokonus, same-end, heating/cooling connection side on left	Aluminium, natural anodised	Roll-up grille	2250	1710	2.4	59

Performance data

Length ¹⁾	Control voltage	Heat output		Heat output		Cooling output, total			Cooling output, total			Power consumption ²⁾	Amperage	SFP	Air flow ³⁾	Sound pressure level ⁴⁾	Sound power level
		at LPHW 75/65 °C, t _{1,1} = 20 °C	Outlet air temperature	at LPHW 55/45 °C, t _{1,1} = 20 °C	Outlet air temperature	at CHW 16/18, t _{1,1} =27 °C, 48% relative humidity	Cooling output, sensitive	Outlet air temperature	at CHW 7/12 °C, t _{1,1} = 27 °C, 48% relative humidity	Cooling output, sensitive	Outlet air temperature						
[mm]	[V]	[W]	[°C]	[W]	[°C]	[W]	[W]	[°C]	[W]	[W]	[°C]	[W]	[mA]	[Ws/ m ²]	[m ³ /h]	[dB(A)]	[dB(A)]
950	10	4645	48.9	2516	37.6	818	818	22.5	1631	1324	19.3	11.6	112	108	386	49	57
	8	3980	50.5	2153	38.5	665	665	21.6	1335	1075	17.8	7.9	77	91	313	41	49
	6	3166	53.4	1706	40.2	490	490	20.6	989	789	16.1	5.2	50	82	227	32	40
	4	2195	59.7	1174	43.8	303	303	19.5	607	479	14.2	3.3	32	90	133	21	29
	2	1223	75.0	640	55.0	120	120	18.4	215	168	12.3	2.3	22	156	53	20	28
1200	10	7152	46.8	3869	36.3	1352	1352	22.5	2690	2184	19.3	21.8	211	123	639	50	58
	8	6089	48.1	3291	37.1	1094	1094	21.6	2186	1760	17.7	13.3	129	92	519	42	50
	6	4833	50.7	2606	38.6	793	793	20.5	1587	1266	15.9	7.3	70	69	377	32	40
	4	3385	56.9	1812	42.2	470	470	19.4	936	739	14.0	3.7	36	61	220	22	30
	2	1933	75.0	1013	54.7	185	185	18.4	335	262	12.2	2.6	25	111	84	20	28
1350	10	8667	46.2	4684	35.9	1674	1674	22.5	3330	2704	19.3	27.0	261	123	792	51	59
	8	7335	47.4	3961	36.6	1354	1354	21.6	2704	2177	17.7	16.4	159	92	642	42	50
	6	5788	49.7	3119	38.0	979	979	20.5	1957	1561	15.9	9.0	87	69	466	33	41
	4	4048	55.6	2168	41.4	572	572	19.3	1135	896	13.9	4.5	44	60	272	23	31
	2	2332	75.0	1223	53.8	222	222	18.3	402	314	12.2	3.2	31	112	102	20	28
1850	10	12555	45.6	6769	35.5	2489	2489	22.5	4953	4021	19.3	38.6	373	118	1177	52	60
	8	10434	46.2	5615	35.8	2014	2014	21.6	4020	3238	17.7	24.4	236	92	955	44	52
	6	7941	47.4	4258	36.5	1455	1455	20.5	2904	2317	15.9	14.2	137	74	693	34	42
	4	5187	50.7	2758	38.3	837	837	19.3	1645	1299	13.9	7.9	76	70	405	24	32
	2	2708	64.8	1409	46.2	281	281	18.2	489	383	12.0	5.5	54	138	145	20	28
2250	10	16884	45.6	9103	35.5	3348	3348	22.5	6661	5408	19.3	54.0	521	123	1583	53	61
	8	14032	46.2	7551	35.8	2708	2708	21.6	5407	4354	17.7	33.0	318	92	1284	45	53
	6	10680	47.4	5726	36.5	1956	1956	20.5	3906	3115	15.9	18.0	174	70	933	36	44
	4	6976	50.7	3710	38.3	1125	1125	19.3	2213	1747	13.9	9.2	88	61	544	25	33
	2	3642	64.8	1895	46.2	377	377	18.2	658	515	12.0	6.4	61	118	195	20	28

Use our calculation tools on our website to easily calculate heat outputs and other technical data with just a few clicks!

▶ <https://www.kampmanngroup.com/hvac/products/trench-technology/katherm-hk#Calculate-performance-data>

¹⁾ Versions with roll-up grille, Katherm HK with linear grille are available on request!

²⁾ Add an additional power consumption of 1 W per thermoelectric actuator, art. no. 194000146906.

³⁾ Values rounded up within the measurement tolerances.

⁴⁾ The sound pressure levels were calculated with an assumed room insulation of 8 dB(A). This corresponds to a distance of 2 m, a room volume of 100 m³ and a reverberation time of 0.5 s (in accordance with VDI 2081) Sound pressure level < 20 dB (A) and sound power level < 28 dB (A) outside the usual measuring and audible range.

Katherm HK

HK 360

4-pipe

Height 210 mm

Technical drawing (Dimensions in mm)

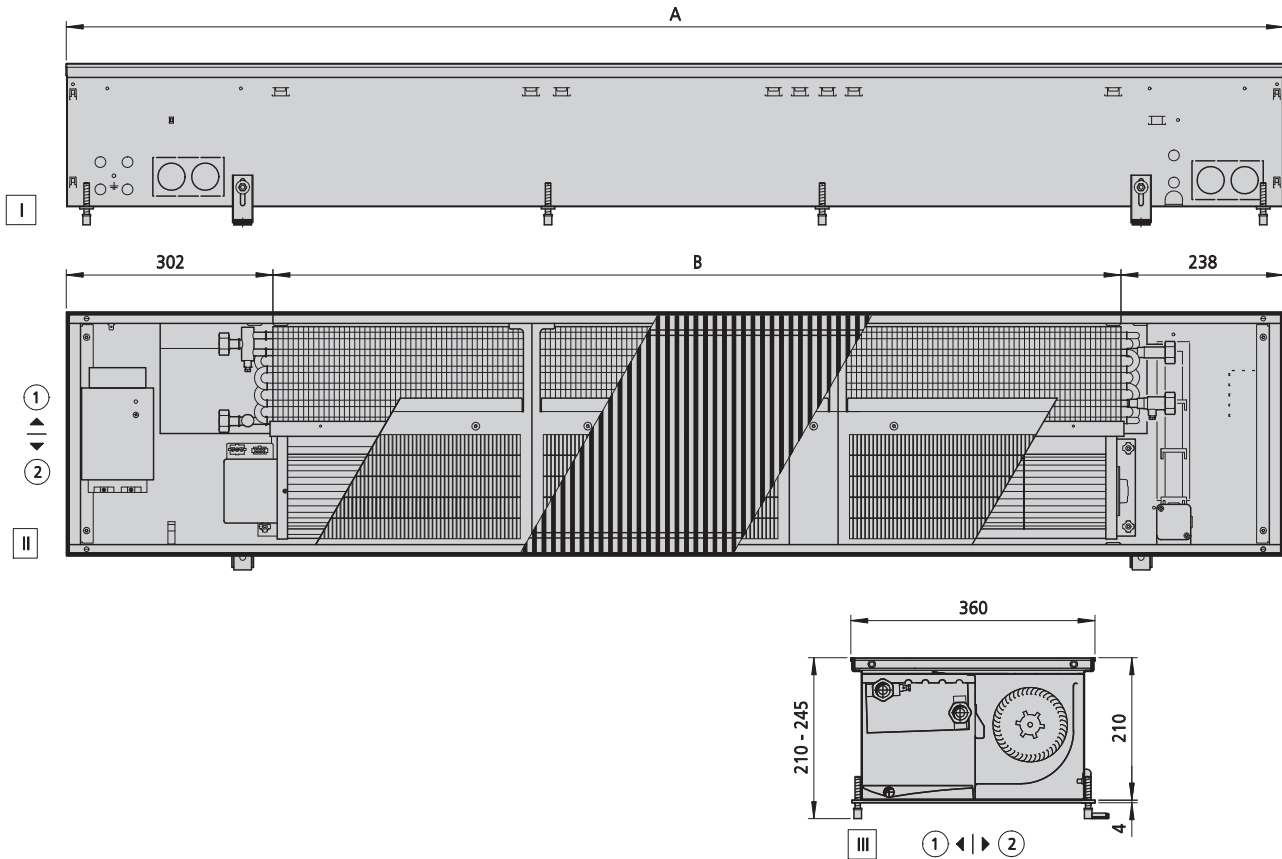

View

- I Front view
- II top view (without cover panel)
- III cross-section

Further information

- ① window side
- ② room side

Specifications

Article no.	Connection	Grille finish	Grille design	Length (A) [mm]	finned length (B) [mm]	Water content [l]	Weight [kg]
143364211114**	EuroKonus, opposite end, cooling connection side on left, heating connection side on right	Aluminium, natural anodised	Roll-up grille	950	410	0.6	25
143364211119**	EuroKonus, opposite end, cooling connection side on left, heating connection side on right	Aluminium, natural anodised	Roll-up grille	1200	660	0.9	32
143364211122**	EuroKonus, opposite end, cooling connection side on left, heating connection side on right	Aluminium, natural anodised	Roll-up grille	1350	810	1.1	36
143364211132**	EuroKonus, opposite end, cooling connection side on left, heating connection side on right	Aluminium, natural anodised	Roll-up grille	1850	1310	1.9	49
143364211140**	EuroKonus, opposite end, cooling connection side on left, heating connection side on right	Aluminium, natural anodised	Roll-up grille	2250	1710	2.4	59

Performance data

Length ¹⁾	Control voltage	Heat output		Heat output		Cooling output, total			Cooling output, total			Power consumption ²⁾	Amperage	SFP	Air flow ³⁾	Sound pressure level ⁴⁾	Sound power level
		at LPHW 75/65 °C, t _{1,1} = 20 °C	Outlet air temperature	at LPHW 55/45 °C, t _{1,1} = 20 °C	Outlet air temperature	at CHW 16/18, t _{1,1} =27 °C, 48% relative humidity	Cooling output, sensitive	Outlet air temperature	at CHW 7/12 °C, t _{1,1} = 27 °C, 48% relative humidity	Cooling output, sensitive	Outlet air temperature						
[mm]	[V]	[W]	[°C]	[W]	[°C]	[W]	[W]	[°C]	[W]	[W]	[°C]	[W]	[mA]	[Ws/ m ²]	[m ³ /h]	[dB(A)]	[dB(A)]
950	10	2982	38.5	1608	31.2	771	771	22.2	1539	1250	18.9	11.6	112	108	386	49	57
	8	2478	39.0	1334	31.5	628	628	21.4	1262	1016	17.4	7.9	77	91	313	41	49
	6	1886	39.9	1011	32.0	464	464	20.4	938	748	15.8	5.2	50	82	227	32	40
	4	1232	42.3	655	33.3	288	288	19.4	578	456	14.1	3.3	32	90	133	21	29
	2	643	52.5	335	39.0	114	114	18.4	203	159	12.3	2.3	22	175	47	20	28
1200	10	4944	38.5	2666	31.2	1273	1273	22.2	2534	2058	18.8	21.8	211	123	639	50	58
	8	4109	39.0	2211	31.5	1031	1031	21.3	2059	1658	17.3	13.3	129	92	519	42	50
	6	3127	39.9	1677	32.0	748	748	20.3	1498	1195	15.7	7.3	70	69	377	32	40
	4	2043	42.3	1086	33.3	445	445	19.3	888	701	13.8	3.7	36	61	220	22	30
	2	1066	52.5	555	39.0	176	176	18.3	318	249	12.2	2.6	25	119	79	20	28
1350	10	6121	38.5	3300	31.2	1576	1576	22.2	3137	2547	18.8	27.0	261	123	792	51	59
	8	5087	39.0	2737	31.5	1275	1275	21.3	2547	2051	17.3	16.4	159	92	642	42	50
	6	3872	39.9	2076	32.0	922	922	20.3	1844	1471	15.6	9.0	87	69	466	33	41
	4	2529	42.3	1345	33.3	541	541	19.2	1074	848	13.8	4.5	44	60	272	23	31
	2	1320	52.5	687	39.0	211	211	18.3	382	299	12.2	3.2	31	117	97	20	28
1850	10	9104	38.5	4908	31.2	2344	2344	22.2	4665	3787	18.8	38.6	373	118	1177	52	60
	8	7566	39.0	4071	31.5	1896	1896	21.3	3786	3049	17.3	24.4	236	92	955	44	52
	6	5758	39.9	3087	32.0	1370	1370	20.3	2735	2182	15.6	14.2	137	74	693	34	42
	4	3761	42.3	2000	33.3	788	788	19.2	1550	1223	13.7	7.9	76	70	405	24	32
	2	1964	52.5	1022	39.0	264	264	18.2	461	360	12.0	5.5	54	138	145	20	28
2250	10	12243	38.5	6601	31.2	3153	3153	22.2	6273	5093	18.8	54.0	521	123	1583	53	61
	8	10175	39.0	5475	31.5	2550	2550	21.3	5092	4101	17.3	33.0	318	92	1284	45	53
	6	7744	39.9	4152	32.0	1842	1842	20.3	3678	2934	15.6	18.0	174	70	933	36	44
	4	5058	42.3	2690	33.3	1060	1060	19.2	2084	1645	13.7	9.2	88	61	544	25	33
	2	2641	52.5	1374	39.0	356	356	18.2	620	485	12.0	6.4	61	118	195	20	28

Use our calculation tools on our website to easily calculate heat outputs and other technical data with just a few clicks!

▶ <https://www.kampmanngroup.com/hvac/products/trench-technology/katherm-hk#Calculate-performance-data>

¹⁾ Versions with roll-up grille, Katherm HK with linear grille are available on request!

²⁾ Add an additional power consumption of 1 W per thermoelectric actuator, art. no. 194000146906.

³⁾ Values rounded up within the measurement tolerances.

⁴⁾ The sound pressure levels were calculated with an assumed room insulation of 8 dB(A). This corresponds to a distance of 2 m, a room volume of 100 m³ and a reverberation time of 0.5 s (in accordance with VDI 2081) Sound pressure level < 20 dB (A) and sound power level < 28 dB (A) outside the usual measuring and audible range.

03 ▶ Design information

Standardraum: Tiefe 5,5 m
Kühllast $\approx 50 \text{ W/m}^2$

↓

ca. $275 \text{ W/m} \times 1,30 = \underline{\underline{358 \text{ W/Raster}}}$

Raster 1300 mm

Kathern HK

100 1200 100

Leerstahl mit Abdeckung für optionale Trennwand

32°C

↑ ca. 1,75 m

Wind. 1 m

↑ Pkw 16/18°C · 4 Läden 1200 mm Länge

Summe:

$t_i = 27^\circ\text{C}$
50% rel. Feuchte

⇒ Kathern HK 320/130 Sen. Kühlleistung 397 W/Raster ✓

Schalldruckpegel: $< 29 \text{ dB (A)}$ ✓ akzeptabel! ✓

Information on planning and design

Katherm HK are suitable for use in all kinds of buildings in which there is a cooling load owing to internal loads and the effects of sunlight.

They are generally positioned directly in front of the external façade without a large gap. Katherm HK can provide cost-effective and efficient cooling, particularly in front of large areas of glazing.

Air outlet

Katherm HK are positioned with the coil on the façade side. If it is arranged on the room side, the high air output would result in lower levels of comfort in the occupied zone.

Acoustics

When designing a system, it should be noted that disruptive noise may occur at higher fan speeds. The respective sound power levels of Katherm HK are indicated in the tables (see "Technical data"). The sound pressure levels were calculated with an assumed room insulation of 8 dB(A). This corresponds to a distance of 2 m, a room volume of 100 m³ and a reverberation time of 0.5 s (in accordance with VDI 2081).

As the sound level is not only due to the Katherm HK, but is also influenced by the number of Katherm HK and also very significantly by the acoustic characteristics of the room, the actual figure may vary in practice. We would recommend designing Katherm HK taking into account the respective permitted sound pressure level in the room.

Heat and cooling outputs

The heat and cooling outputs were calculated based on DIN EN 16430. We would recommend using our online calculation programs to convert to other operating conditions at:
kampmann.de/katherm-hk/calculation.

Katherm HK E Heat outputs

The heat output characteristic curve to determine the control voltage was measured taking into consideration DIN EN 60335, Part 1, Part 2 - 30 and Part 2 - 40.

Comfort

Comfort was calculated taking into consideration DIN EN ISO 7730 (May 2006) "Ergonomics of the thermal environment – analytical determination and interpretation of thermal comfort by calculation of the PMV and the PDB indexes and criteria of local thermal comfort" (ISO 7730:2004).

The air outlet and air flows have been optimised in detail in accordance with this standard.

Make use of our online calculation programs to calculate your heat outputs, cooling outputs and flow rates simply and easily with a couple of clicks!

► kampmanngroup.com/katherm-hk/calculation

Planning of Katherm HK E for optional heating in electric mode

Optional electric heating function

Electric heating is possible in addition to water-based heating and cooling with the 2-pipe Katherm HK E version with an integrated continuously variably

controlled electric heating element. This means that the heat requirement of a room can be met either by the coil and also directly by the electric heating element.

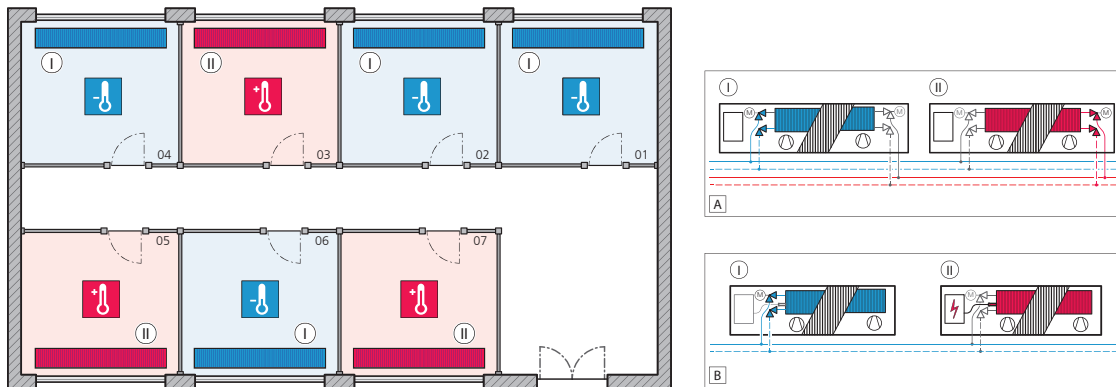

Example: Floor of an office building with multiple single offices

A 4-pipe operation with a coil (CHW cooling/LPHW heating)

B 2-pipe operation of the HK E with a coil (CHW cooling) and heating by the electric element

I Cooling

II Heating

Katherm HK E 2-pipe system as a comfort solution

In normal 2-pipe operation, rooms are either cooled (CHW cooling) or heated (LPHW heating) via the coil. The system needs to be centrally switched over to change from cooling to heating mode. The Katherm HK E with electric heating element offers a 2-pipe solution with the comfort and convenience of a 4-pipe system. The decisive benefits are as follows:

- ▶ Individual determination of the room climate by the user of the room. The electric heating element can be used for heating, regardless of the other offices, although the other offices might still be in cooling mode. The Katherm HK E takes over a 4-pipe function.
- ▶ Flexible room design becomes possible.
- ▶ The electric heating element can be used to provide full heating, depending on the heat requirement. In the event of a higher heat requirement, for instance with cold outside temperatures in winter, the heat requirement can be met by the coil in water-based heating mode.

Sustainable 4-pipe system solution at the cost of a 2-pipe system

The use of Katherm HK E offers the following benefits compared to a traditional 4-pipe system, which also have an impact on the sustainability rating of a building:

- ▶ Saving in terms of pipework for a 4-pipe system within the floors and risers, including distribution pipes, connection piping, fittings and vales.
- ▶ Significant raw material savings and lower material costs.
- ▶ Reduced CO₂ emissions along the value chain.
- ▶ Considerably shorter installation time and lower commission costs.
- ▶ Positive carbon footprint by the use of green electricity from renewable energy sources.

HK-E control functions

A. How does the control work?

The electric heating element and the EC tangential fan can be continuously variably controlled in the electric heating-power output. Heating or cooling operating mode is defined externally in the system setting via a potential-free contact. In cooling mode, chilled water is fed to the system and the room user has the option of individually cooling with chilled water (**CHW cooling**) or heating with the electric heating element (**electric heating**) depending on the day and the temperature. When the system is set to heating mode, LPHW is fed to the system – in this case, heating can only be provided by the coil (**LPHW heating**).

The following control concepts are available for the control of the Katherm HK E.

a. Electromechanical version (-00):

The control responds to on-site signals or Kampmann room thermostats. The switch-over between cooling/heating mode must be done by a contact on site. A potential-free collective fault signal is optionally available.

b. KaControl version (-C1):

The control is provided by the Kampmann KaControl system. Every unit is equipped with its own intelligence. The switch-over between cooling/heating mode must be done by a contact on site.

B. Switch-over between operating modes

The operating modes of the Katherm HK E can be switched via an external potential-free contact. When the contact is open, **LPHW heating** operating mode is specified. When the contact is closed, cooling is possible in **CHW cooling** operating mode or heating in **Electric heating** operating mode.

C. Electric heating operating mode

The fan starts up at the minimum fan speed at a control voltage of approx. 1.5 V. The electric heating element is switched on from approx. 2 V. This can regulate the heat output between 40% and 100% within a range of 2 V to 6 V. It means that the full heat output is reached at the design point at a low sound power level.

D. Safety shut-off device

Every Katherm HK E is fitted with a safety shut-off device. If the temperature of the grille surface rises impermissibly high if the unit is used incorrectly, for instance by covering the trench, the heat output is automatically reduced. If the temperature cannot be reduced, then the safety temperature limiter shuts down the unit. The fact that the safety temperature limiter has triggered and other fault messages can be reported via a potential-free alarm contact.

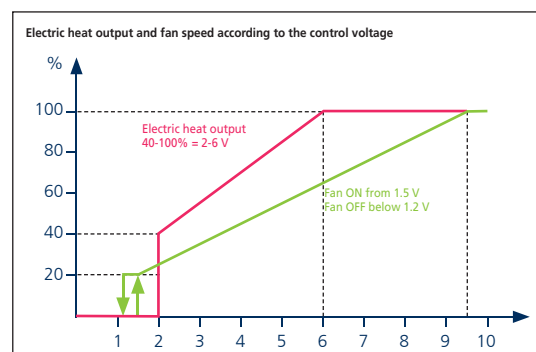

Water connections – Pipe openings

Katherm HK 245/160, 2-pipe, trench height 160 mm

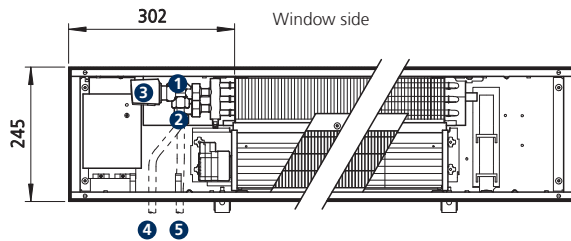

Top view

- 1 1/2" valve body, axial, type 346914 and/or type 346911 (flow-dependent)
- 2 1/2" return shut-off valve, angled, type 145953
- 3 Thermoelectric actuator, type 146906
Alternatively: Valve kit type 143241 or type 143211 (flow-dependent)
- 4 Heating/cooling supply
- 5 Heating/cooling return

Katherm HK 245/160, 4-pipe, trench height 160 mm

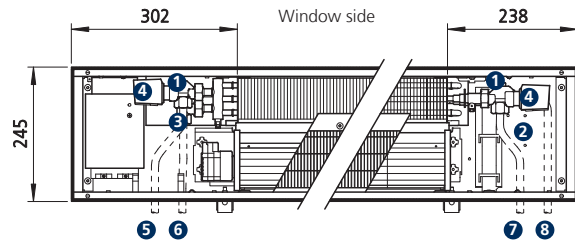

Top view

- 1 1/2" valve body, axial, type 346914 and/or type 346911 (flow-dependent)
- 2 1/2" return shut-off valve, straight, type 145952
- 3 1/2" return shut-off valve, angled, type 145953
- 4 Thermoelectric actuator, type 146906
Alternatively: Valve kit type 143441 or type 143411 (flow-dependent)
- 5 Cooling supply
- 6 Cooling return
- 7 Heating supply
- 8 Heating return

Katherm HK 290/160, 2-pipe, trench height 160 mm

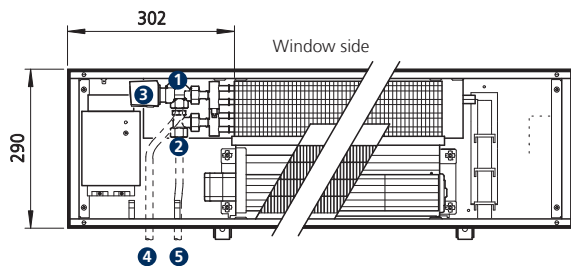

Top view

- 1 1/2" valve body, axial, type 346914 and/or type 346911 (flow-dependent)
- 2 1/2" return shut-off valve, angled, type 145953
- 3 Thermoelectric actuator, type 146906
Alternatively: Valve kit type 143241 or type 143211 (flow-dependent)
- 4 Heating/cooling supply
- 5 Heating/cooling return

Katherm HK 290/160, 4-pipe, trench height 160 mm

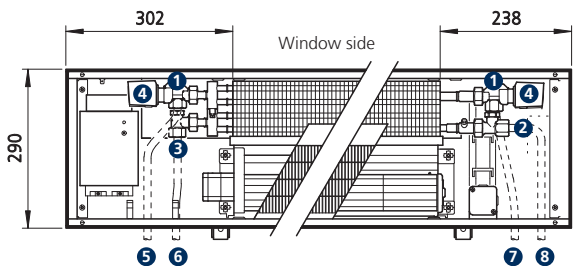

Top view

- 1 1/2" valve body, axial, type 346914 and/or type 346911 (flow-dependent)
- 2 1/2" return shut-off valve, straight, type 145952
- 3 1/2" return shut-off valve, angled, type 145953
- 4 Thermoelectric actuator, type 146906
Alternatively: Valve kit type 143441 or type 143411 (flow-dependent)
- 5 Cooling supply
- 6 Cooling return
- 7 Heating supply
- 8 Heating return

Katherm HK 320/130, 2-pipe, trench height 130 mm

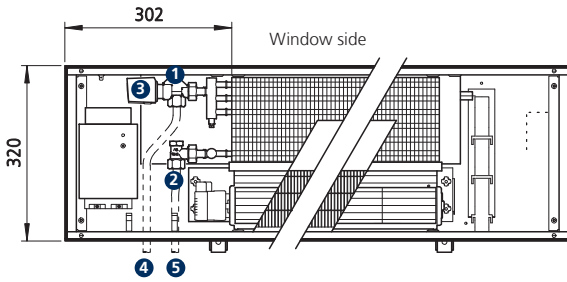

Top view

- 1 1/2" valve body, axial, type 346914 and/or type 346911 (flow-dependent)
- 2 1/2" return shut-off valve, angled, type 145953
- 3 Thermolectric actuator, type 146906
Alternatively: Valve kit type 143241 or type 143211 (flow-dependent)
- 4 Heating/cooling supply
- 5 Heating/cooling return

Katherm HK 320/130, 4-pipe, trench height 130 mm

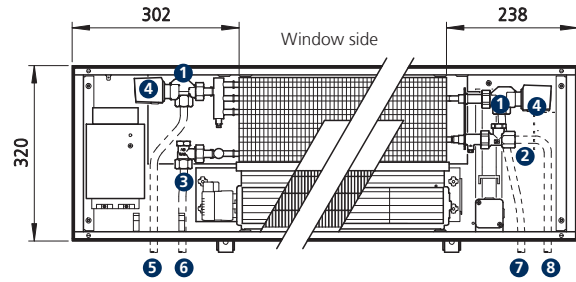

Top view

- 1 1/2" valve body, axial, type 346914 and/or type 346911 (flow-dependent)
- 2 1/2" return shut-off valve, straight, type 145952
- 3 1/2" return shut-off valve, angled, type 145953
- 4 Thermolectric actuator, type 146906
Alternatively: Valve kit type 143441 or type 143411 (flow-dependent)
- 5 Cooling supply
- 6 Cooling return
- 7 Heating supply
- 8 Heating return

Katherm HK 320/130 E, 2-pipe, trench height 130 mm

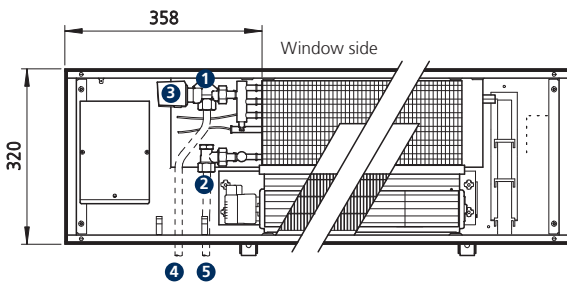

Top view

- 1 1/2" valve body, axial, type 346914 and/or type 346911 (flow-dependent)
- 2 1/2" return shut-off valve, angled, type 145953
- 3 Thermolectric actuator, type 146906
Alternatively: Valve kit type 143241 or type 143211 (flow-dependent)
- 4 Heating/cooling supply
- 5 Heating/cooling return

Katherm HK 360/210, 2-pipe, trench height 210 mm

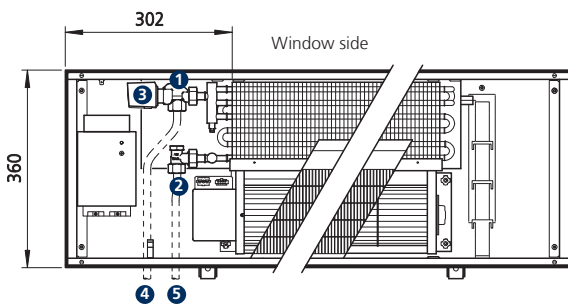

Top view

- 1 1/2" valve body, axial, for higher flow, type 346914
- 2 1/2" return shut-off valve, for higher flow, angled, type 145955
- 3 Thermolectric actuator, type 146906
Alternatively: Valve kit type 143241
- 4 Heating/cooling supply
- 5 Heating/cooling return

Katherm HK 360/210, 4-pipe, trench height 210 mm

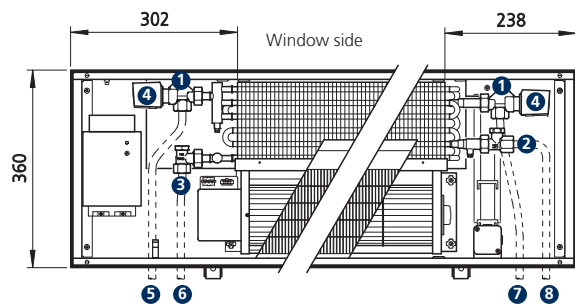

Top view

- 1 1/2" valve body, axial, for higher flow, type 346914
- 2 1/2" return shut-off valve, for higher flow, straight, type 145954
- 3 1/2" return shut-off valve, for higher flow, angled, type 145955
- 4 Thermolectric actuator, type 146906
Alternatively: Valve kit type 143441
- 5 Cooling supply
- 6 Cooling return
- 7 Heating supply
- 8 Heating return

04 ▶ Controls

24 V electromechanical version

Version for complete on-site control of the Katherm HK (not for Katherm HK 360) or via convenient clock thermostats.

Product features

- ▶ The operating voltage must be provided by a central on-site 24 V DC power supply.
- ▶ The external power supply ensures space-saving connections in the floor trench so that the hydraulic connection can be conveniently performed.
- ▶ In the event of a motor malfunction, e.g. overloading, the fault alarm is internally evaluated and the fan is automatically disabled.

Electromechanical control type 30456



Flush-mounted clock thermostat with 10-stage fan speed setting including day and week programme

Product features:

- ▶ large illuminated display with four sensor keys
- ▶ can be integrated into any 50 x 50 switch program
- ▶ can be integrated using an intermediate frame into a 55 x 55 switch program
- ▶ white cover panel and frame (similar to RAL 9010)
- ▶ integral room temperature sensor
- ▶ room/frost protection function (temperature measurement within the clock thermostats).
- ▶ integrated day or weekly program timer programs with automatic summer/winter changeover
- ▶ 24 V operating and output voltage (0-10 V fan control)
- ▶ for use with Katherm HK and HK E, max. 5 units

Information on cable laying

Note the following points with the cabling and wiring diagrams for the electrical installation:

- ▶ Comply with the details on the type of cable and cabling, taking into consideration VDE 0100.
 - ▶ Without *: NYM-J. The requisite number of wires, including PE conductor, is stated on the cable. Cross-sections are not stated, as the cable length is involved in the calculation of the cross-section.
 - ▶ With *: J-Y(ST)Y 0.8 mm. Lay separately from high voltage lines.
 - ▶ If other types of cables are used, they must be at least equivalent.
- ▶ The terminals on the unit are suitable for a maximum wire cross-section of 2.5 mm².
 - ▶ We recommend type F when using RCCBs. Refer to the provisions of DIN VDE 0100 Parts 400 and 500 when designing the rated fault current.
 - ▶ The electrical data listed in the following table needs to be considered when configuring the mains supply and fuses on site.

Electrical data for the Katherm HK 320/130, 245/160, 24 V electromechanical version (*24)

Trench length	Fans	Nominal voltage	Mains frequency	Nominal power	Nominal current	Operating current	Ri-analogue input	IP class	Protection class
[mm]	[Quantity]	[V DC]	[Hz]	[W]	[A]	[mA]	[kΩ]		
915	1 (3600)	24	/	6	0.25	/	200	IP00	III
1200	1 (3600)	24	/	11	0.46	/	200	IP00	III
1700	1 (10800)	24	/	18	0.75	/	200	IP00	III
2000	2 (6000, 6000)	24	/	22	0.92	/	100	IP00	III
2500	2 (10800, 6000)	24	/	29	1.21	/	100	IP00	III
3000	2 (10800, 10800)	24	/	35	1.46	/	100	IP00	III

Electrical data for the Katherm HK 290/160, 24 V electromechanical version (*24)

Trench length	Fans	Nominal voltage	Mains frequency	Nominal power	Nominal current	Operating current	Ri-analogue input	IP class	Protection class
[mm]	[Quantity]	[V DC]	[Hz]	[W]	[A]	[mA]	[kΩ]		
950	1 (380)	24	/	9	0.38	/	100	IP00	III
1200	1 (630)	24	/	14	0.60	/	100	IP00	III
1700	2 (630, 380)	24	/	24	1.00	/	50	IP00	III
2000	2 (630, 680)	24	/	29	1.20	/	50	IP00	III
2500	3 (630, 680, 380)	24	/	38	1.60	/	33	IP00	III
3000	3 (730, 730, 730)	24	/	44	1.90	/	33	IP00	III

Katherm HK, 24 V electromechanical, 2- or 4-pipe, valve actuator(s) 24 V AC/DC Open/Closed, actuation by BMS

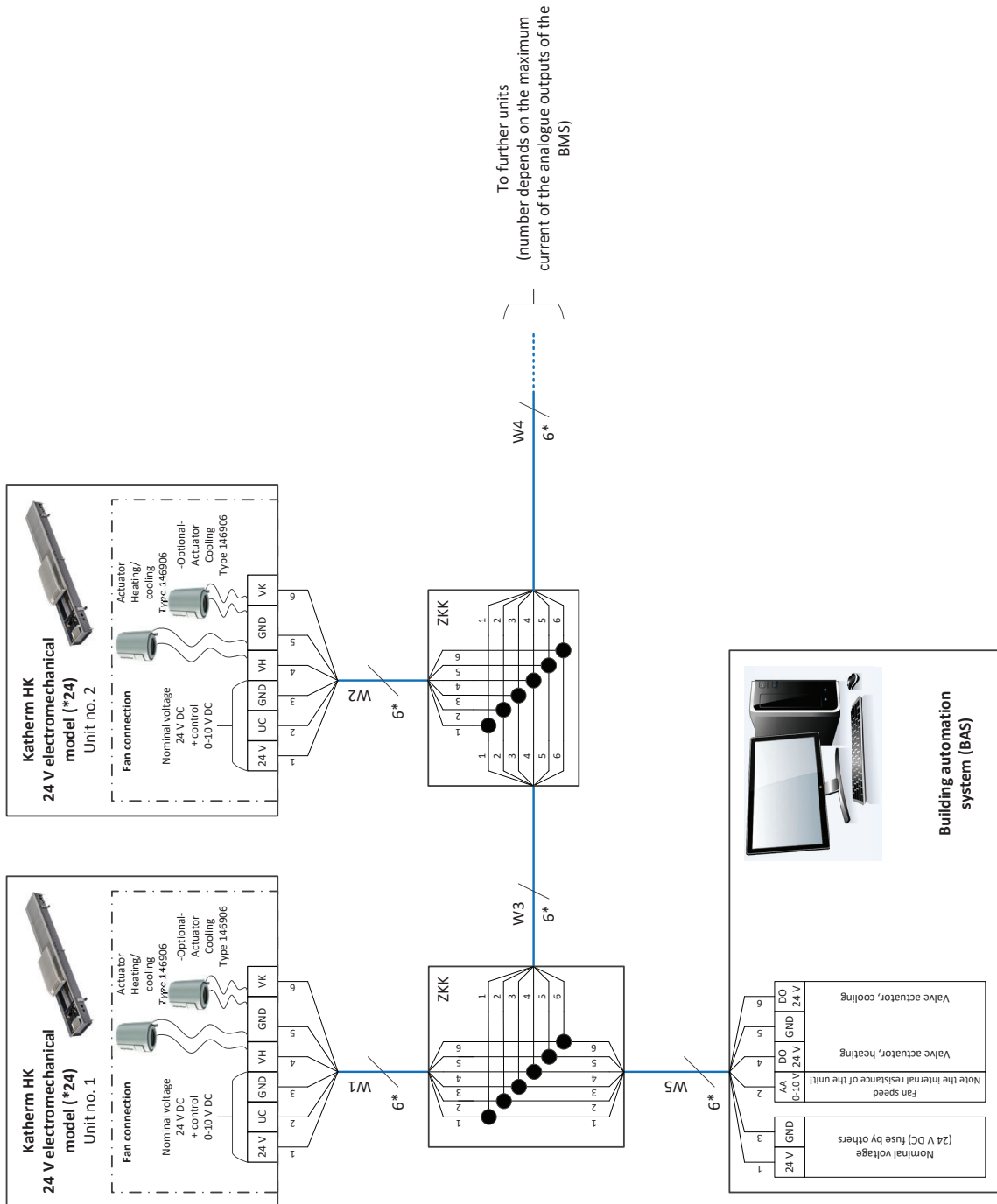

Control of Katherm HK electromechanical version (*00)

Product features

In the electromechanical version (*00), the Katherm HK has an integrated power supply unit 230 V AC/24 V DC. The factory-fitted fan is wired to a terminal. The appropriate terminals are available for valve actuators.

Fans

The fan speed of the EC fans used can be continuously variably controlled by a 0-10 V DC signal. The "intelligent" motor electronics detect any possible motor malfunction and automatically switch off the fan.

Control units

Kampmann offers extensive control accessories for operation.

Room thermostat, type 196000030155



Room thermostat for 3-stage speed control for surface wall-mounted installation in an attractive restrained design

Product features:

- ▶ 2- and 4-pipe applications, thermal valve actuators 230 V AC Open/Closed, normally closed
- ▶ ABS plastic housing, functional and robust design, pure white, similar to RAL 9010, for surface-mounting on a flush back box
- ▶ Simple operation using a large dial for temperature setting with mechanical range limitation of the temperature setpoint, operating mode selector switch, Standby, Manual fan, Automatic fan, 3-stage switch for pre-selecting fan speed when operating mode selector switch is in the "Manual fan" position
- ▶ control input for heating/cooling switch-over with 2-pipe systems
- ▶ control input can either be set to Comfort/ECO or ON/OFF switch-over
- ▶ room frost protection function $< 5\text{ }^{\circ}\text{C} \rightarrow$ heating valve open, fan stage 3
- ▶ optional use of the internal or external room temperature sensor (accessory)
- ▶ for use with Katherm HK, max. 5 units

Climate controller type 196000146928



Room temperature controller with setpoint display by means of arrow indicators in a visually understated design

Product features:

- ▶ 2- and 4-pipe applications, setpoint display by arrow indicators, control range 13-29 degrees
- ▶ ABS plastic housing, robust design, pure white, similar to RAL 9010, surface-mounted
- ▶ control input can either be set to Comfort/ECO or ON/OFF switch-over
- ▶ unit frost protection function $< 5\text{ }^{\circ}\text{C} \rightarrow$ valve(s) open
- ▶ Parallel operation of 5 units is possible
- ▶ for use with Katherm HK E, max. 5 units

Climate Controller type 196000148941 / type 196000148942 / type 196000148943 / type 196000148944



The Climate Controller is a control unit with a high-quality glass finish

Product features:

- ▶ 2- and 4-pipe - applications, thermal valve actuators 230 V AC Open/Closed, normally closed
- ▶ 2.5" LCD display
- ▶ high-quality glass surface with capacitive keys
- ▶ LED ring acts as key feedback
- ▶ selection of the value to be displayed (room temperature, setpoint, setpoint offset)
- ▶ Automatic LED backlight
- ▶ optional use of the internal or external room temperature sensor (accessory)
- ▶ room temperature control
- ▶ parametrisable room frost protection function → RT < 8 °C = heating valve open, fan stage 1
- ▶ parametrisable unit frost protection function → RT < 4° C = valve(s) open, fan off
- ▶ standby mode
- ▶ Eco/day switch-over
- ▶ manual or automatic mode
- ▶ functional display
- ▶ alarm display
- ▶ Timer program with 3 time channels, each with 4 switch-over points
- ▶ cleaning mode
- ▶ parametrisable language: German or English
- ▶ Modbus RTU slave interface to wire to higher-level building automation system (BAS) (only with type 148943 and type 148944)
- ▶ 3 control inputs with type 148941 and type 148942 or 2 control inputs with type 148943 and type 148944 (parametrisable functions e.g. window contact, motion detector, heating/cooling switch-over), external room sensor
- ▶ password-protected parameter level
- ▶ surface-mounted on a flush box
- ▶ pure white (type 148941 and type 148943) or black (type 148942 and type 148944)
- ▶ for use with Katherm HK, max. 4 units

Operating using on-site systems

Control via analogue and digital signals is also possible as an alternative to the Kampmann control units. The following analogue and digital inputs and / or outputs are needed:

- ▶ speed control via a 0-10 VDC signal, the fan starts up safely at 1.5 V DC
- ▶ control input for the detection of a possible condensate alarm → only with electromechanical version with condensate pump
- ▶ digital signals to control the valve actuator(s) according to the actuator version
- ▶ potential-free contact for switch-over (only with Katherm HK E)

Information on cable laying

The following points need to be taken into account with the cable laying and wiring plans stated for the electrical installation:

- ▶ Comply with the details on the type of cable and cabling, taking into consideration VDE 0100.
- ▶ Without *: NYM-J. The requisite number of wires, including PE conductor, is stated on the cable. Cross-sections are not stated, as the cable length is involved in the calculation of the cross-section.
- ▶ With *: J-Y(ST)Y 0.8 mm. Lay separately from high voltage lines.
- ▶ If other types of cables are used, they must be at least equivalent.
- ▶ The terminals on the unit are suitable for a maximum wire cross-section of 2.5 mm².
- ▶ We recommend type F when using RCCBs. Refer to the provisions of DIN VDE 0100 Parts 400 and 500 when designing the rated fault current.
- ▶ The electrical data listed in the following table needs to be considered when configuring the mains supply and fuses on site.

Electrical data for the Katherm HK 320/130, 245/160, 230 V electromechanical version (*00)

Trench length	Fans	Nominal voltage	Mains frequency	Nominal power	Nominal current	Operating current	Ri-analogue input	IP class	Protection class
[mm]	[Quantity]	[V AC]	[Hz]	[W]	[A]	[mA]	[kΩ]		
915	1 (3600)	230	50	7	0.82	/	200	IP00	I
1200	1 (6000)	230	50	12	0.12	/	200	IP00	I
1700	1 (10800)	230	50	19	0.17	/	200	IP00	I
2000	2 (6000, 6000)	230	50	23	0.24	/	100	IP00	I
2500	2 (10800, 6000)	230	50	30	0.29	/	100	IP00	I
3000	2 (10800, 10800)	230	50	36	0.34	/	100	IP00	I

Electrical data for the Katherm HK E 320/130, 230 V electromechanical version (*00)

Trench length	Fans	Nominal voltage	Mains frequency	Nominal power	Nominal current	Operating current	Ri-analogue input	IP class	Protection class
[mm]	[Quantity]	[V AC]	[Hz]	[W]	[A]	[mA]	[kΩ]		
915	1 (3600)	230	50	530	2.30	/	200	IP00	I
1200	1 (6000)	230	50	1030	4.60	/	200	IP00	I
1700	1 (10800)	230	50	1030	4.60	/	200	IP00	I
2000	2 (6000, 6000)	230	50	1030	4.60	/	100	IP00	I
2500	2 (10800, 6000)	230	50	1540	6.90	/	100	IP00	I
3000	2 (10800, 10800)	230	50	1540	6.90	/	100	IP00	I

Electrical data for the Katherm HK 290/160, 230 V electromechanical version (*00)

Trench length	Fans	Nominal voltage	Mains frequency	Nominal power	Nominal current	Operating current	Ri-analogue input	IP class	Protection class
[mm]	[Quantity]	[V AC]	[Hz]	[W]	[A]	[mA]	[kΩ]		
950	1 (380)	230	50	13	0.12	/	100	IP00	I
1200	1 (630)	230	50	19	0.16	/	100	IP00	I
1700	2 (630, 380)	230	50	29	0.22	/	50	IP00	I
2000	2 (630, 680)	230	50	35	0.26	/	50	IP00	I
2500	3 (630, 680, 380)	230	50	47	0.34	/	33	IP00	I
3000	3 (730, 730, 730)	230	50	53	0.38	/	33	IP00	I

Electrical data for the Katherm HK 360/210, 230 V electromechanical version (*00)

Trench length	Fans	Nominal voltage	Mains frequency	Nominal power	Nominal current	Operating current	Ri-analogue input	IP class	Protection class
[mm]	[Quantity]	[V AC]	[Hz]	[W]	[A]	[mA]	[kΩ]		
950	1 (380)	230	50	12	0.11	/	100	IP00	I
1200	1 (630)	230	50	22	0.21	/	100	IP00	I
1350	1 (780)	230	50	27	0.26	/	100	IP00	I
1850	2 (780, 730)	230	50	39	0.37	/	50	IP00	I
2250	2 (780, 780)	230	50	54	0.52	/	50	IP00	I

Katherm HK, 230 V electromechanical, 2- or 4-pipe, valve actuator(s) 230 V AC Open/Closed, optional condensate pump, with Climate Controller type 14894x

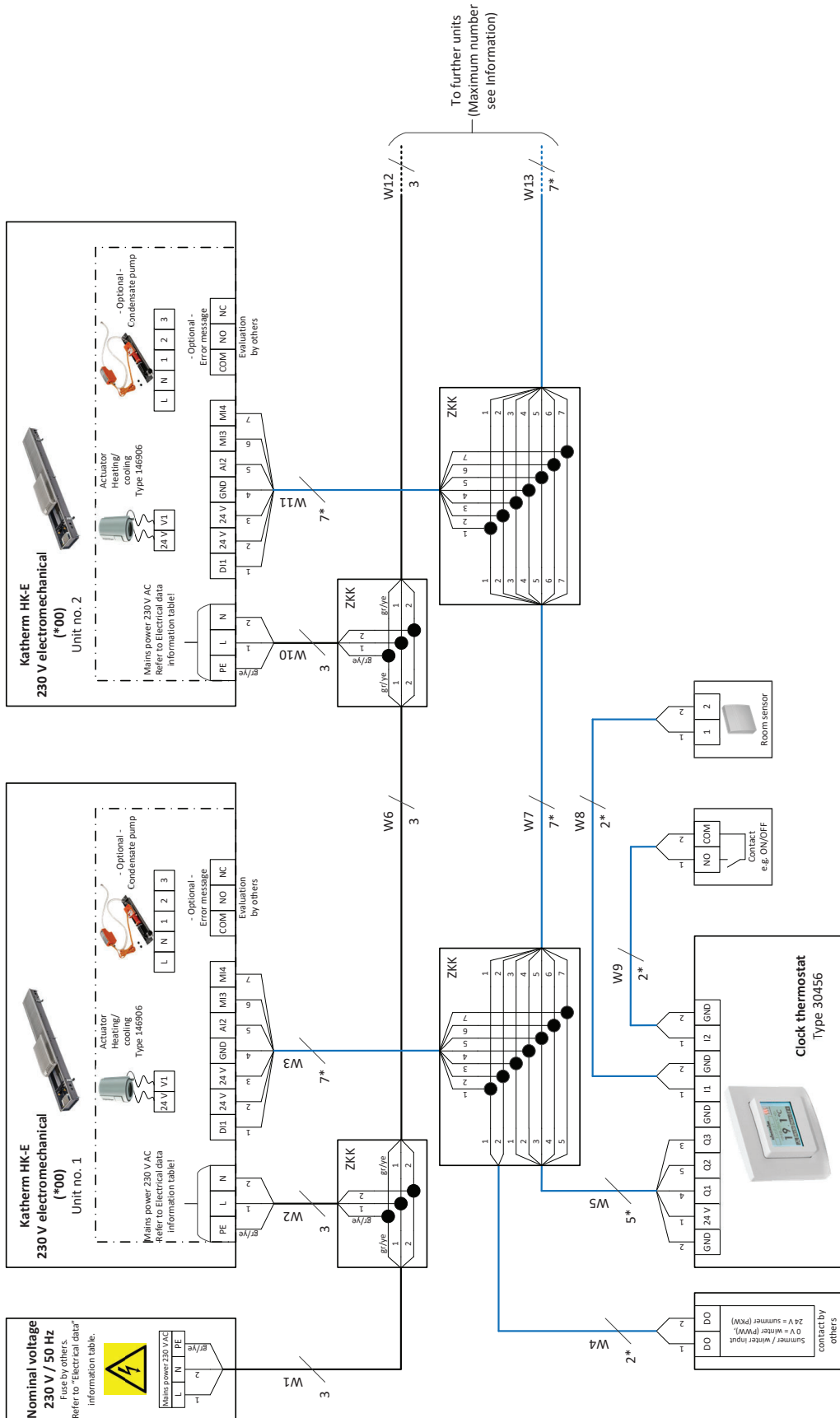

Katherm HK, 230 V electromechanical, 2- or 4-pipe valve actuator(s) 230 V AC Open/Closed, optional condensate pump, with room thermostat type 30155

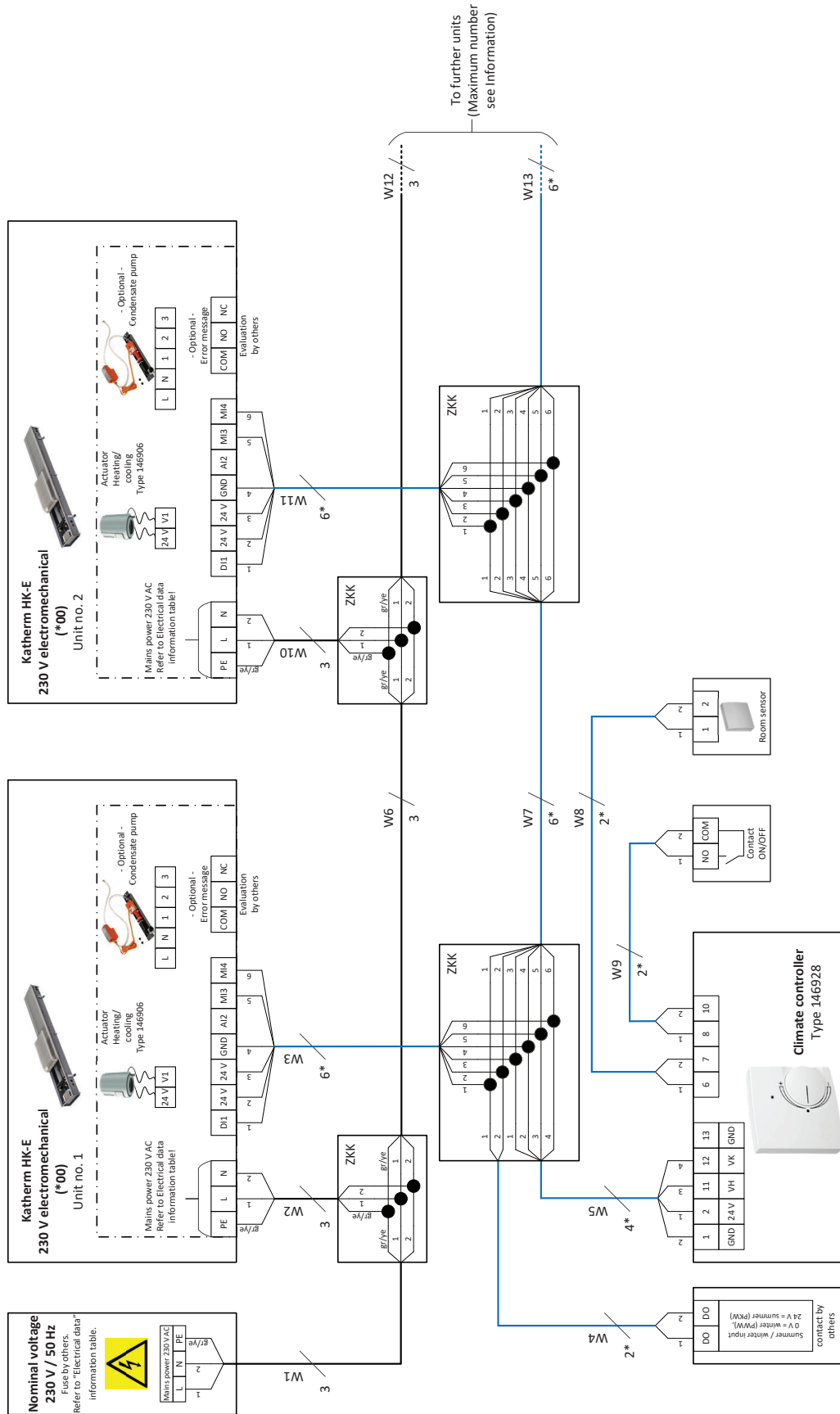

Katherm HK-E, 230 V electromechanical, 2-pipe, electric heating element, valve actuator 24 V AC/DC Open/Closed, optional condensate pump, actuation by BA

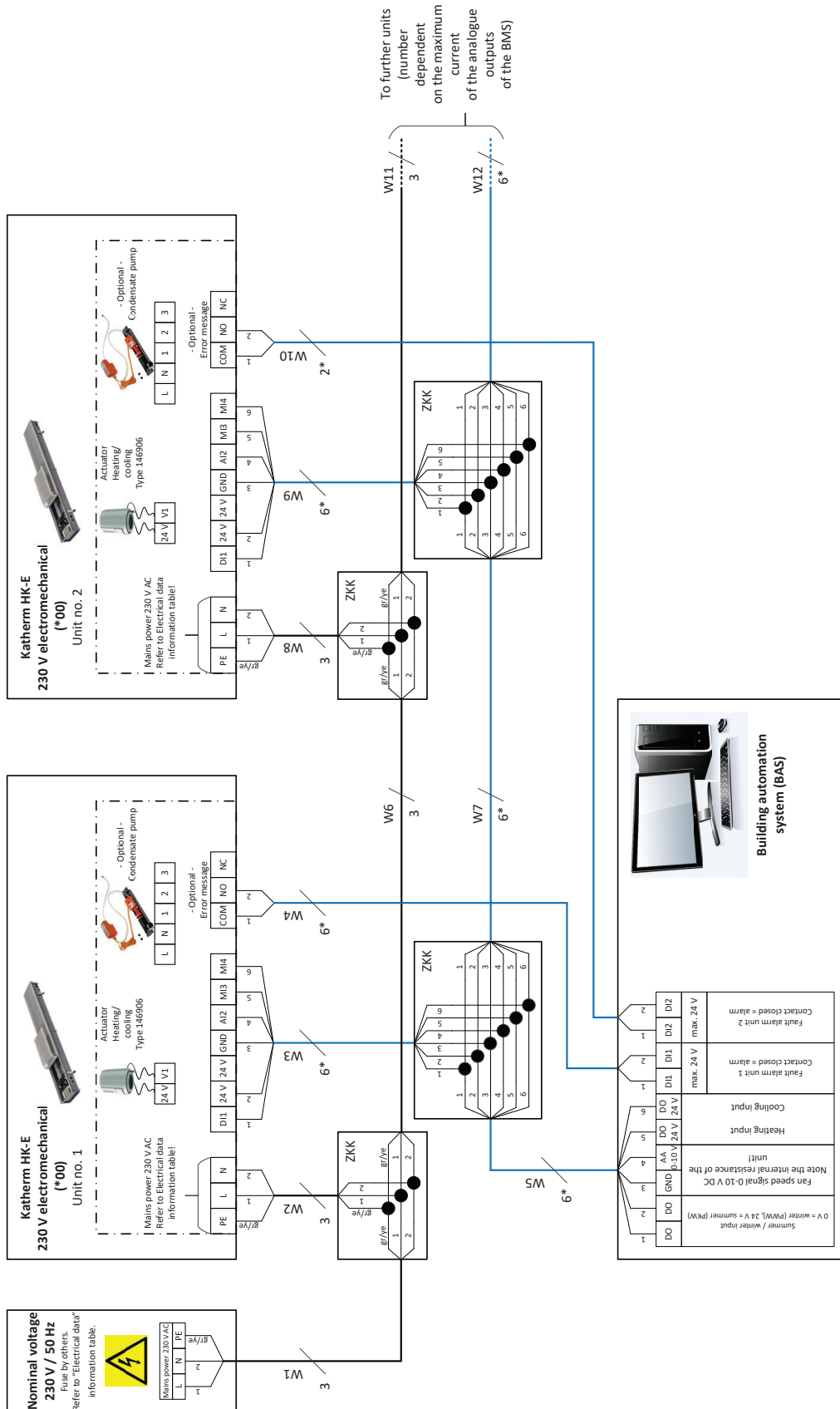

Katherm HK-E, 230 V electromechanical, 2-pipe, electric heating element, valve actuator 24 V AC/DC Open/Closed, optional condensate pump, clock thermostat type 30456

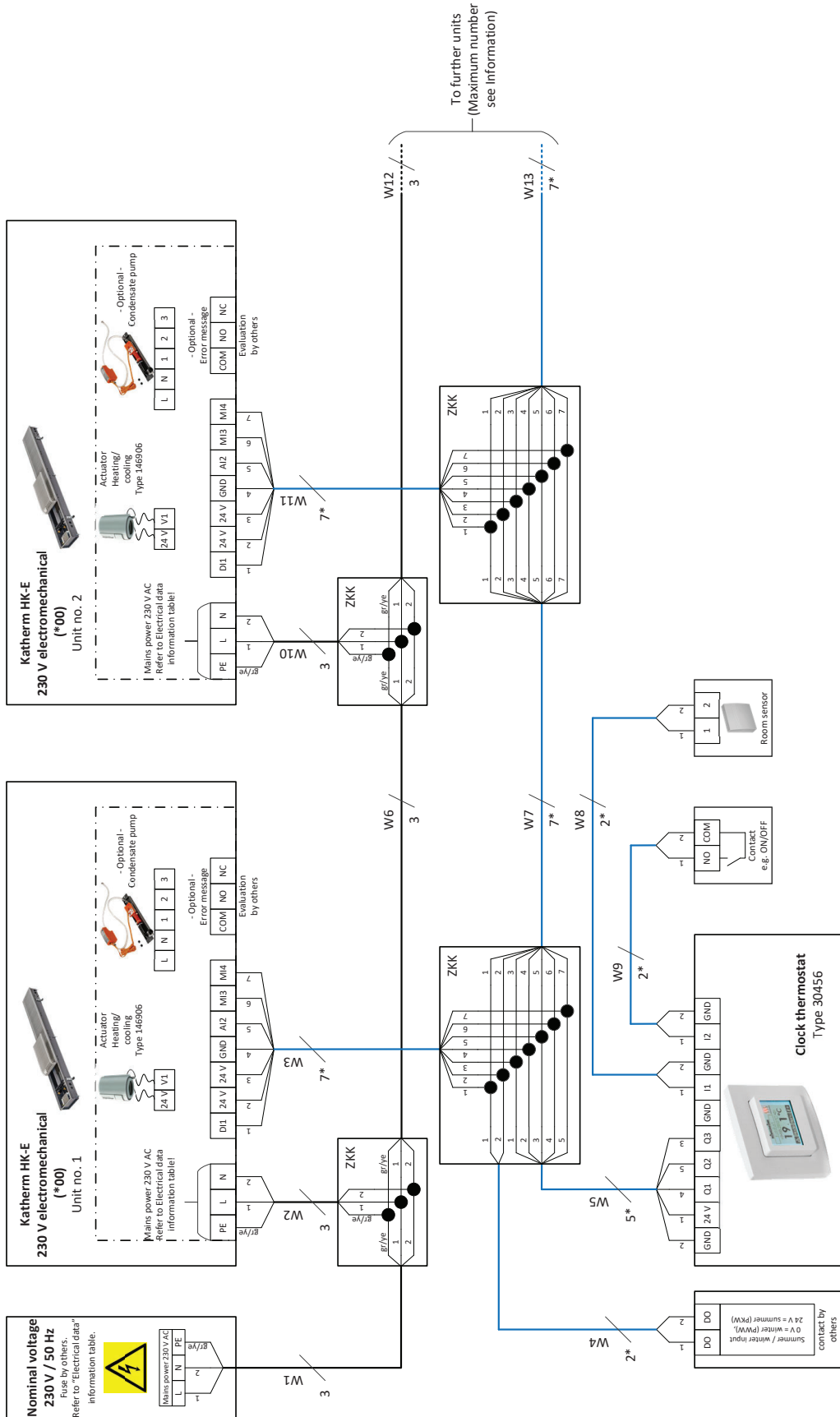

Katherm HK-E, 230 V electromechanical, 2-pipe, electric heating element, valve actuator 24 V AC/DC Open/Closed, optional condensate pump, Climate Controller type 146928

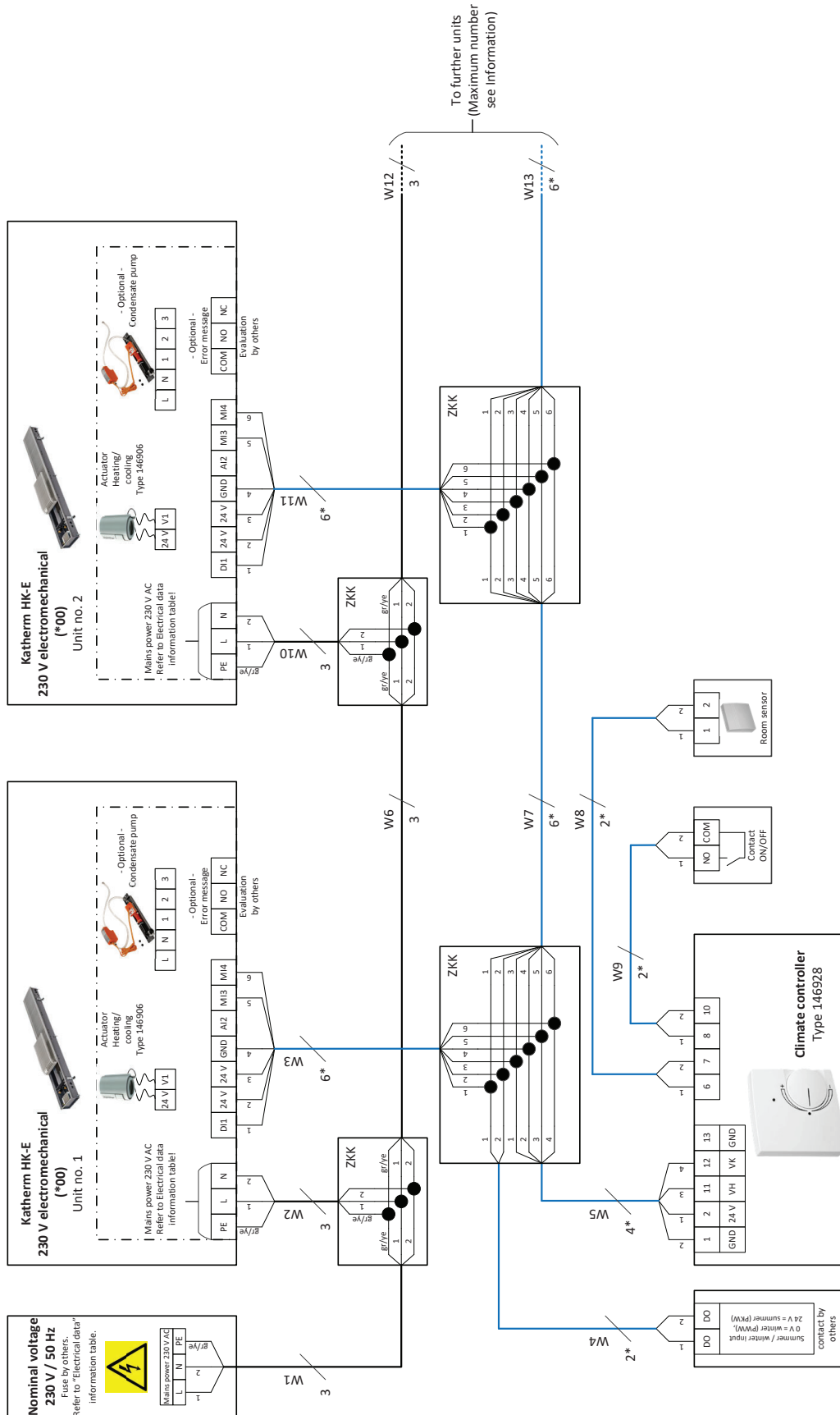

Control of Katherm HK, KaControl version

The all-inclusive solution!

Product features

Units configured for operation with KaControl are fully wired and fitted with all electrical parts ready for connection (with the exception of optional accessories). The built-in, high-performance, parametrisable KaControl microprocessor control provides all the functions that the Katherm HK needs. The "face" of the KaControl is the KaController control unit.

A group of up to six units can be formed using a KaController control unit without the need for additional addressing.

Optional plug-in interface cards offer the option of connecting to higher-level control systems.

Fans

The fan speed of the EC fans used in the units is controlled by a 0-10 V DC signal from the KaControl. The "intelligent" motor electronics detect any possible motor malfunction and automatically switch off the fan. A motor malfunction on the unit to which the KaController is connected is displayed on the KaController.

Control unit

Various versions of the KaController control unit are available for operation and control.

KaController

Type 196003210001



Type 196003210002



Type 196003210006



The KaController offers maximum operating convenience with a large display, one-touch operation and optionally also with side function keys for quick access. Based on the principle of "as little as possible, as much as required", even untrained users can intuitively get to grips with the control options. The displays are language-independent using pictograms. The basic functions are inputted in a user-friendly way using the KaController.

Product features of the KaController

- ▶ plastic housing, colour similar to RAL 9010 (type 196003210001 and 196003210002) or black (type 196003210006) for surface-mounting on a flush back box or surface-mounting with a surface-mounted frame (accessory)
- ▶ high-quality design of room control units, large PCD multifunctional display with energy-saving, automatically switching LED backlight
- ▶ push-turn navigator dial with endless turn/lock function
- ▶ side function keys for quick access (only with type 196003210002)
- ▶ integral temperature sensor
- ▶ individually adjustable basic display
- ▶ display of fault messages
- ▶ built-in weekly switching program
- ▶ password-protected parameter level
- ▶ 24 V DC/max 0.5 A switch output parametrisable to unit alarm, heat or cooling demand (only with 2-pipe applications)
- ▶ sequential control of the valve (Open/Closed) and fan speed via one (2-pipe) or two data points 0-10 V DC (4-pipe) → only with control without KaController
- ▶ one slot for optional interface cards for connection to a higher-level building automation system → optionally Modbus, KNX, BACnet (accessory)
- ▶ password-protected parameter level
- ▶ parallel operation of a maximum of 6 units is possible, extendible to a maximum of 30 units using additional CANbus cards type 3260701 (accessory) per unit

Any additional functions required can be parametrised and correspondingly coordinated.

KaControl control function

The parametrisable KaControl microprocessor control offers a wealth of functions. The following factory settings are set for the Venkon product:

- ▶ 2- and 4-pipe - applications, thermal valve actuators 24 V DC Open/Closed, normally closed
- ▶ room temperature control with 2-point valve control and demand-led fan control in automatic operation or optionally fixed stage selection
- ▶ room frost protection function → $RT < 8\text{ °C}$ = heating valve open, fan stage 1
- ▶ unit frost protection function → $RT < 4\text{ °C}$ = valve(s), fan off
- ▶ optional use of the internal or external room temperature sensor (accessory)
- ▶ in the event of an alarm being triggered on a device to which the KaController room control unit is connected, e.g. a motor malfunction or condensate alarm is detected by the KaControl and indicated on the KaController control unit
- ▶ control input for heating/cooling switch-over with 2-pipe systems
- ▶ control input can either be set to Comfort/ECO or ON/OFF switch-over

Information on cable laying

The following points need to be taken into account with the cable laying and wiring diagrams for the electrical installation:

- ▶ Comply with the details on the type of cable and cabling, taking into consideration DE 0100.
 - ▶ Without *: NYM-J. The requisite number of wires, including PE conductor, is stated on the cable. Cross-sections are not stated, as the cable length is involved in the calculation of the cross-section.
 - ▶ With *: J-Y(ST)Y 0.8 mm. Lay separately from high voltage lines.
 - ▶ With **: UNITRONIC BUS LD 0.22 mm². Lay separately from high voltage lines.
 - ▶ If other types of cables are used, they must be at least equivalent.
 - ▶ Length of the BUS line from the KaController to unit 1: max. 30 m.
 - ▶ Maximum number of parallel units: 6 units. CANbus cards type 3260701 needed for each unit (see accessories) maximum 30 no.
- ▶ Length of Bus line from unit 1 to the last unit max. 30 m. The cable length can be increased to 500 m using CANbus cards type 3260701 (see accessories).
 - ▶ The terminals on the unit for the mains power supply are suitable for a maximum wire cross-section of 2.5 mm².
 - ▶ We recommend type F when using RCCBs. Refer to the provisions of DIN VDE 0100 Parts 400 and 500 when designing the rated fault current.
 - ▶ The electrical data listed in the following table needs to be considered when configuring the on-site mains power supply and fuses.

Electrical data for Katherm HK 320/130, 245/160, KaControl version (*C1)

Trench length	Fans	Nominal voltage	Mains frequency	Nominal power	Nominal current	Operating current	Ri-analogue input	IP class	Protection class
[mm]	[Quantity]	[V AC]	[Hz]	[W]	[A]	[mA]	[kΩ]		
915	1 (3600)	230	50	7	0.82	/	200	IP00	I
1200	1 (6000)	230	50	12	0.12	/	200	IP00	I
1700	1 (10800)	230	50	19	0.17	/	200	IP00	I
2000	2 (6000, 6000)	230	50	23	0.24	/	100	IP00	I
2500	2 (10800, 6000)	230	50	30	0.29	/	100	IP00	I
3000	2 (10800, 10800)	230	50	36	0.34	/	100	IP00	I

Electrical data for Katherm HK 290/160, KaControl version (*C1)

Trench length	Fans	Nominal voltage	Mains frequency	Nominal power	Nominal current	Operating current	Ri-analogue input	IP class	Protection class
[mm]	[Quantity]	[V AC]	[Hz]	[W]	[A]	[mA]	[kΩ]		
950	1 (380)	230	50	13	0.12	/	100	IP00	I
1200	1 (630)	230	50	19	0.16	/	100	IP00	I
1700	2 (630, 380)	230	50	29	0.22	/	50	IP00	I
2000	2 (630, 680)	230	50	35	0.26	/	50	IP00	I
2500	3 (630, 680, 380)	230	50	47	0.34	/	33	IP00	I
3000	3 (730, 730, 730)	230	50	53	0.38	/	33	IP00	I

Electrical data for Katherm HK 360/210, KaControl version (*C1)

Trench length	Fans	Nominal voltage	Mains frequency	Nominal power	Nominal current	Operating current	Ri-analogue input	IP class	Protection class
[mm]	[Quantity]	[V AC]	[Hz]	[W]	[A]	[mA]	[kΩ]		
950	1 (380)	230	50	12	0.11	/	100	IP00	I
1200	1 (630)	230	50	22	0.21	/	100	IP00	I
1350	1 (780)	230	50	27	0.26	/	100	IP00	I
1850	2 (780, 730)	230	50	39	0.37	/	50	IP00	I
2250	2 (780, 780)	230	50	54	0.52	/	50	IP00	I

Katherm HK, KaControl C1, 2- or 4-pipe, valve actuator(s) 24 V DC Open/Closed, optional condensate pump, actuation 0-10 V DC via BA

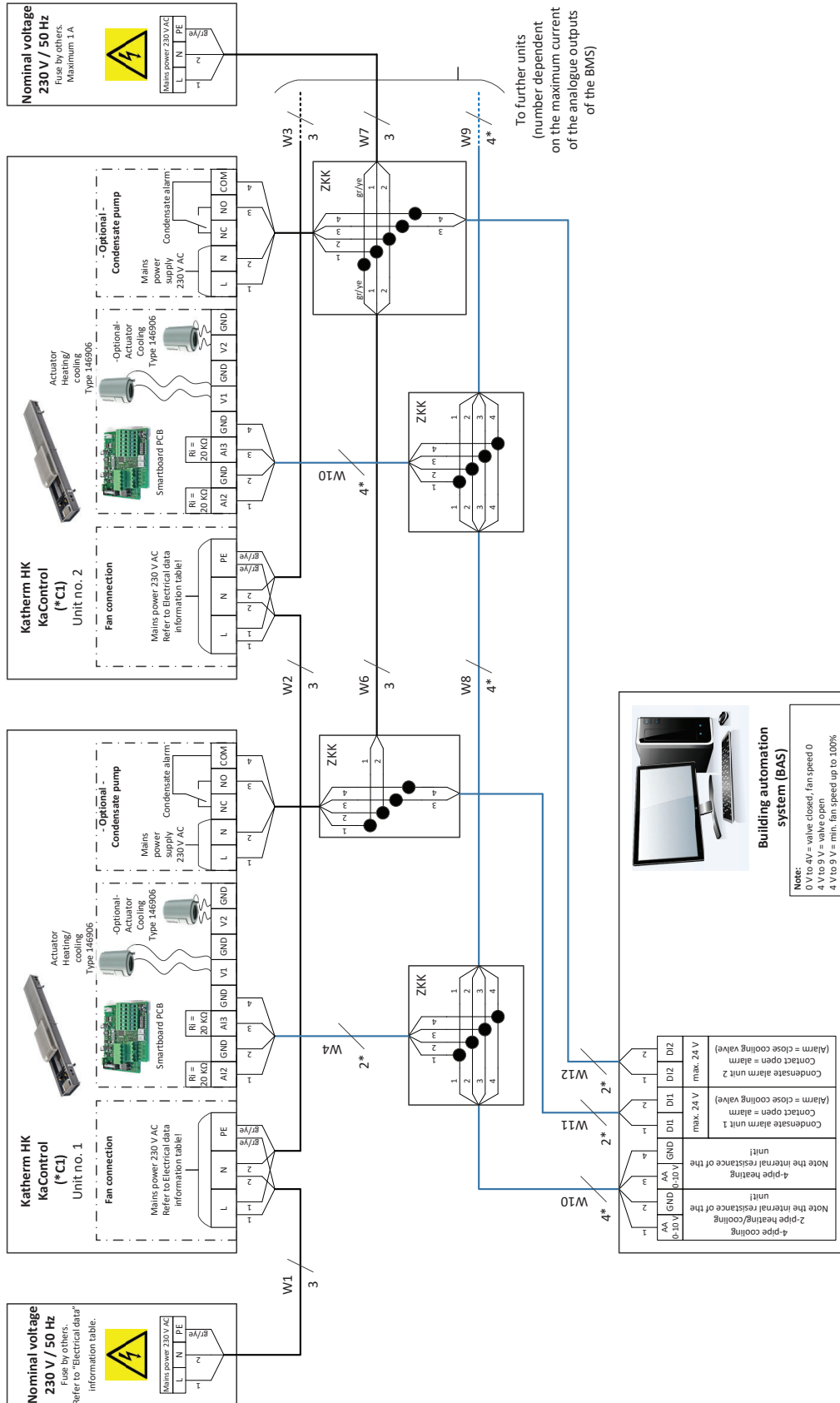

Katherm HK, KaControl C1, 2- or 4-pipe, valve actuator(s) 24 V DC Open/Closed, optional condensate pump, with KaController type 321000x

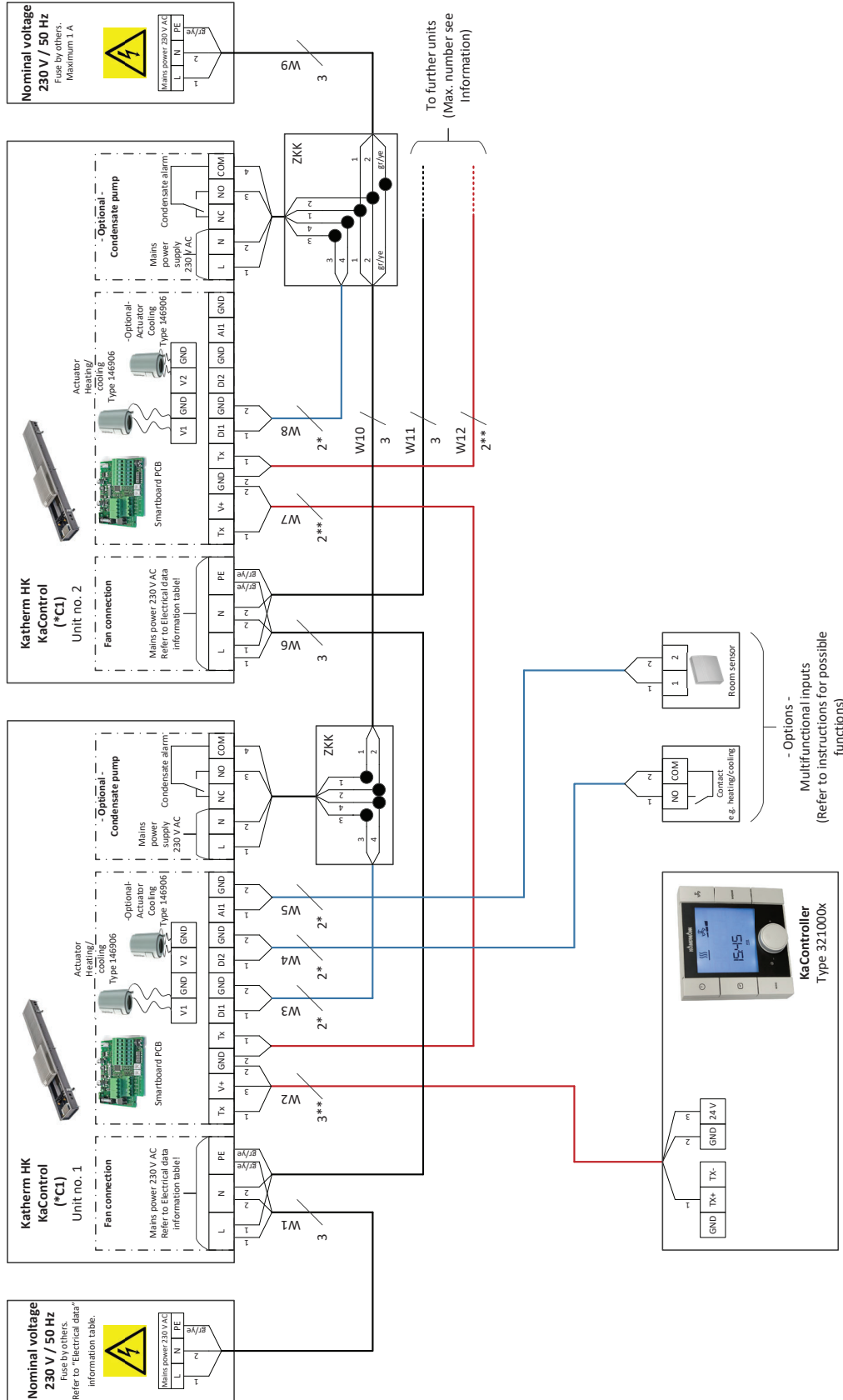

Katherm HK-E with KaControl, 2-pipe, electric heating element, valve actuator 24 V/DC Open/Closed, optional condensate pump, actuation by KaController

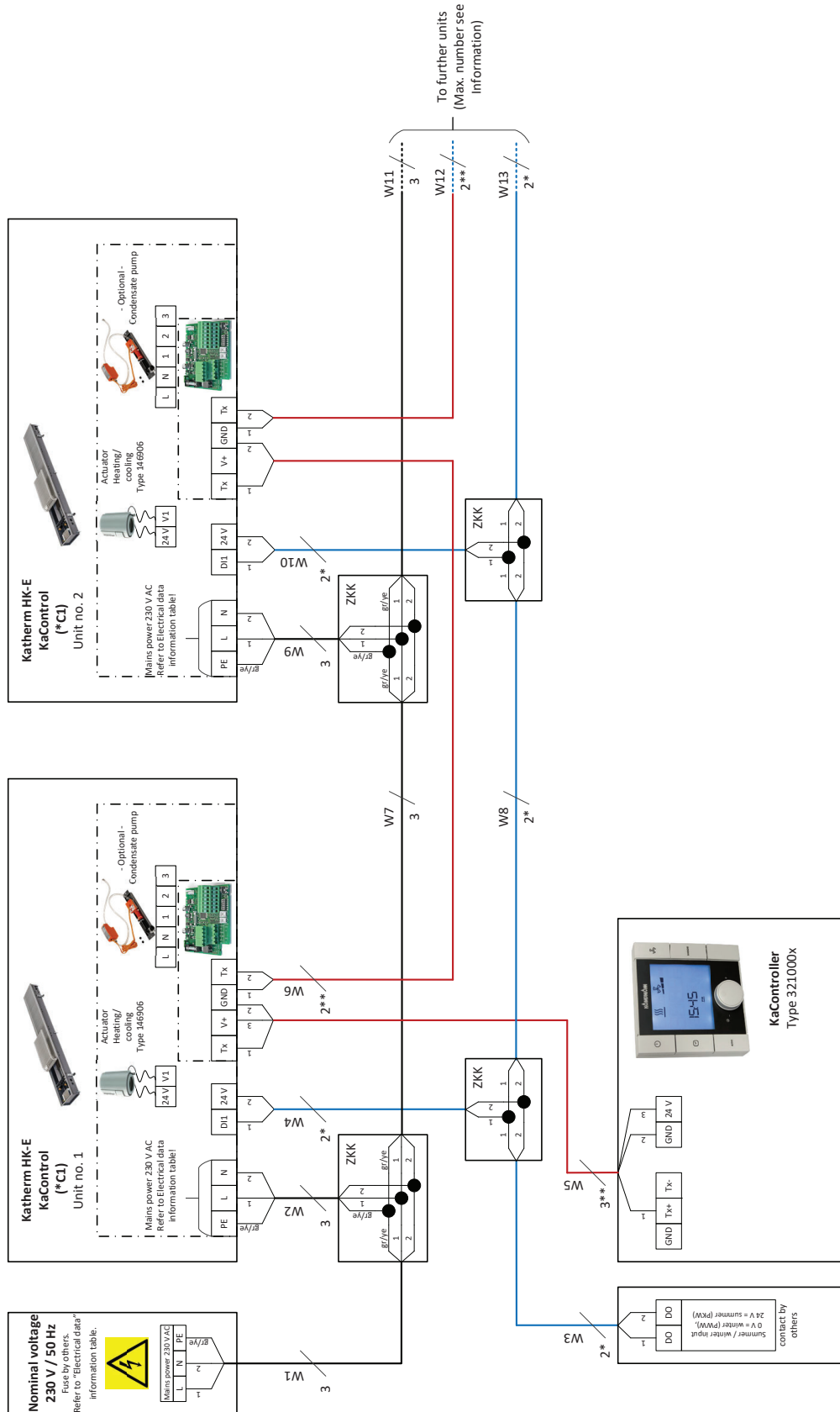

KaControl – Integration into intelligent building networks (IoT)

KaControl offers a wealth of options for integration into established communication networks. Various building automation strategies can be configured using different options.

Individual switching of units

Units with KaControl configuration can be directly integrated into on-site networks using optional communication interfaces. Control and monitoring is provided by fixed data points. Operation is provided by the KaController or by the control units belonging to the network.

Switching of groups

Up to six units with KaControl configuration can be operated in a single group. Groups of units can be directly integrated into on-site networks using optional communication interfaces. Control and monitoring is provided by fixed data points. Operation of a group is provided by the KaController or by control units belonging to the network.

Communication interfaces

The following communication interfaces can be supplied separately or factory-fitted.

- ▶ Modbus RTU
- ▶ KNX

Note:

More information on integration into intelligent building networks and the associated communication interfaces is available on request!

KaControl – system controller

The optional Modbus interface allows units with KaControl configuration to be networked into systems individually or into groups with factory-programmed higher-level Kampmann system controllers.

KaControl SEL control panel 4.0



- ▶ for the monitoring and control of up to 60 Kampmann secondary air units, split into up to 25 groups (zones), maximum 6 units per groups
- ▶ central and zone-wide heating/cooling switch-over
- ▶ own timer program per zone/room
- ▶ integrated web server
- ▶ optional BACnet licence is available

KaControl AUL control panel



- ▶ one Kampmann ventilation system
- ▶ up to 60 secondary air units or door air curtains split into up to 10 groups (zones), identical units required within a group, up to 6 units per group
- ▶ optional: KaController control unit for each group
- ▶ central heating (winter)/cooling (summer) switch-over of secondary air units or heating (winter)/ventilation (summer)
- ▶ 5 timer programs can be assigned to groups
- ▶ optional: BACnet IP gateway for connection to higher-level control systems for the units/zones

KaControl visualisation



- ▶ up to 100/300 units
- ▶ optional: KaController control unit for each group
- ▶ central heating (winter)/cooling (summer) switch-over of secondary air units or heating (winter)/ventilation (summer) of door air curtains
- ▶ central timer programs
- ▶ visualisation of Kampmann secondary air units, door air curtains and ventilation systems

Note:

More information on KaControl system controllers can be provided on request!

Kathern HK concept with KaControl and Modbus card, actuation via SEL 4.0 control panel



Mains 50 Hz

KaControl SEL4.0 control panel

Ethernet

- Outdoor temperature sensor
- Return air temperature sensor
- Chiller
- Heat generator
- Heating pump Heating/cooling
- Heating/cooling changeover valves
- Faults
-

Room / temperature zone 1

KaController

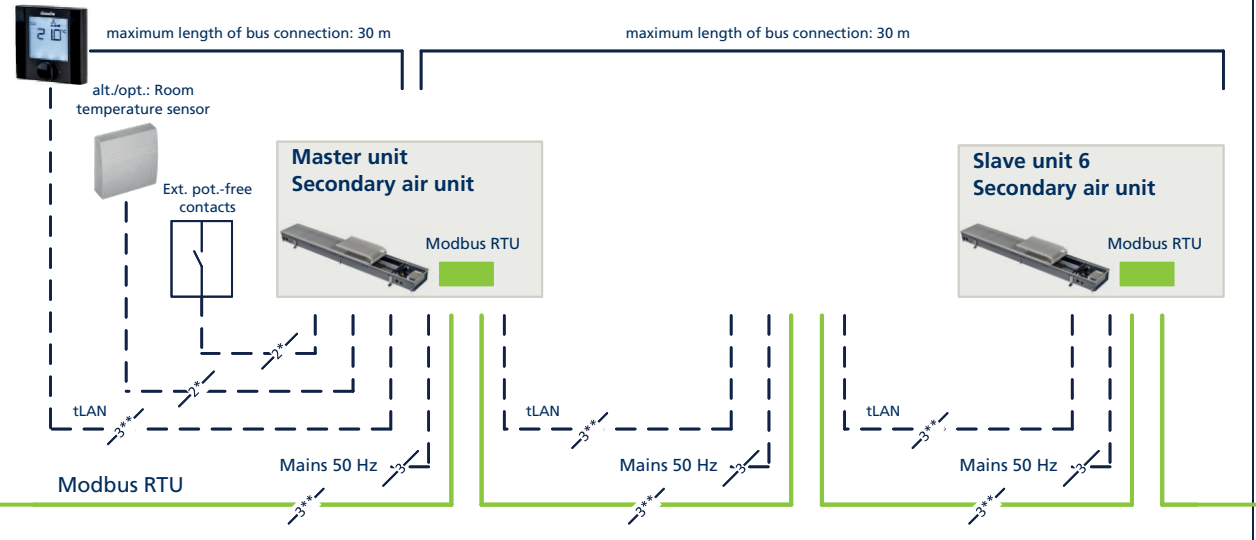

Room / temperature zone 25

KaController

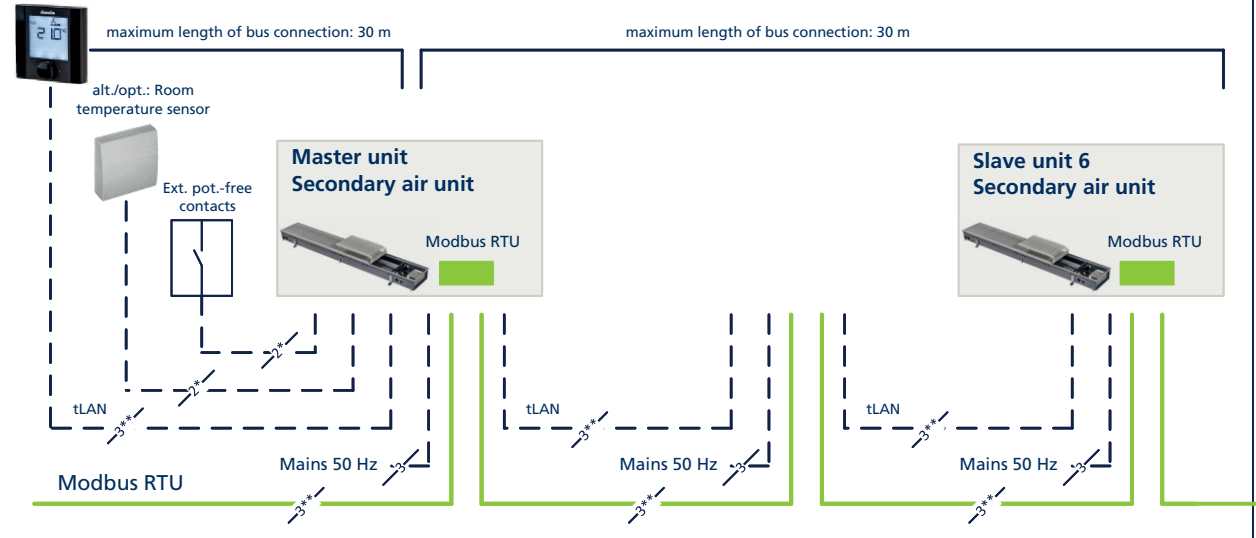

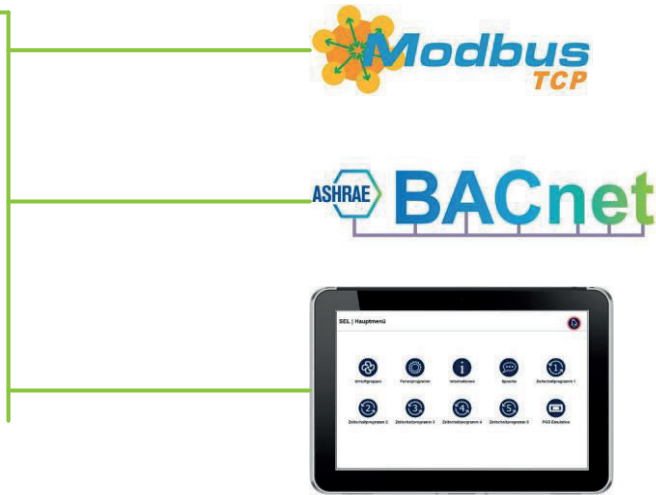

Room / temperature zone 2

KaController

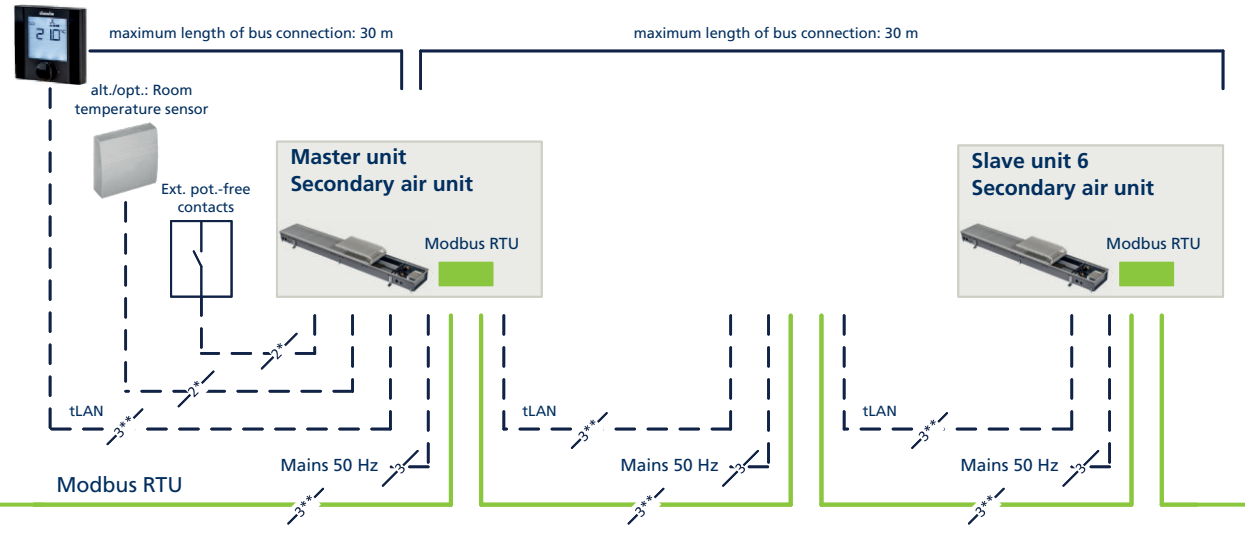





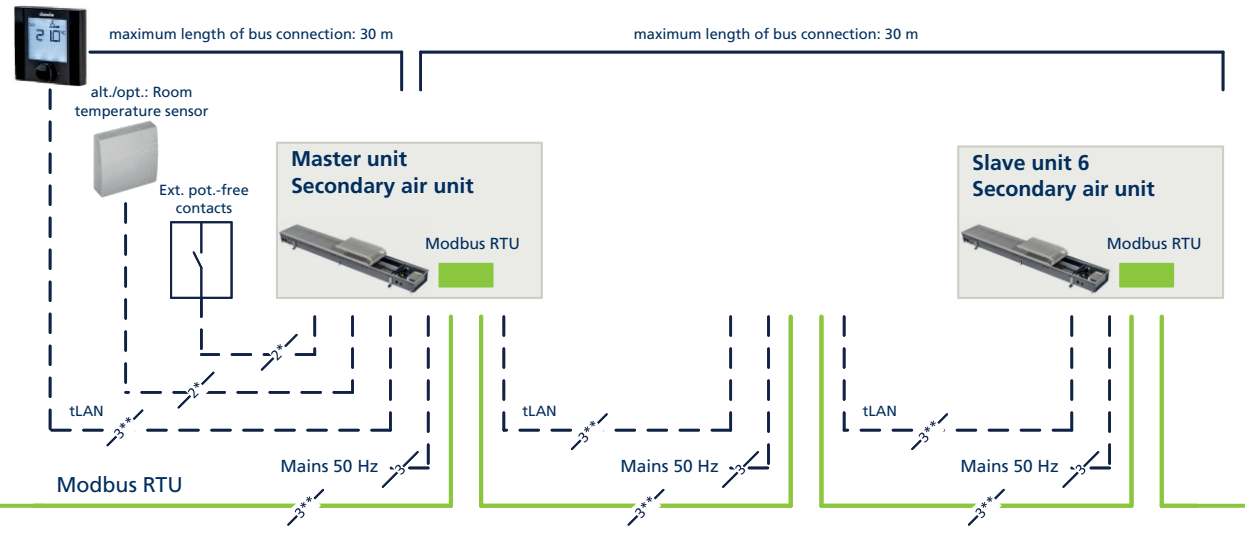



Room / Temperature zone "n"

KaController



05 ▶ Ordering information

Accessories

Article	Article	Properties	Dimensions [mm]	Suitable for	Article no.
Control accessories KaControl					
	KaController	with one-button operation, 24 V wall-mounted room control unit, with integral room temperature sensor, Protection class IP 30, Temperature setting range -8 - -35 °C, Colour similar to RAL 9010 pure white, plastic	86 x 52 x 86	all units with control option KaControl -C1	196003210001
	KaController	with one-button operation, 24 V wall-mounted room control unit, with integral room temperature sensor, Protection class IP 30, Colour similar to RAL 9017 traffic black, plastic	86 x 52 x 86	all units with control option KaControl -C1	196003210006
	KaController	with side operating keys, 24 V wall-mounted room control unit, with integral room temperature sensor, Protection class IP 30, Colour similar to RAL 9010 pure white, plastic	86 x 52 x 86	all units with control option KaControl -C1	196003210002
	Room temperature sensor	Wall-mounted, Surface-mounted, Protection class IP 30, Colour similar to RAL 9010 pure white, plastic Is the KaController installation site suitable for a temperature measurement? - If it is not suitable, e.g. behind a curtain, then a KaControl room temperature sensor should be chosen for each group!	101 x 110 x 23	all units with KaControl -C1 and climate controller art. no. 19600014894*	196003250110
	Clip-on pipe sensor	to detect the medium temperature, heating/cooling changeover function only in conjunction with 3-way valve!, Protection class IP 67, Temperature setting range -20 - 70 °C, Colour black Is there a risk of frost, e.g. due to the ingress of cold air – if so, then a KaControl clip-on pipe sensor should be chosen for each unit!	5 x 6 x 3000	all units with KaControl -C1 and climate controller art. no. 19600014894*	196003250115
	Serial KNX card	for integration into a KNX/EIB network, interface PCOS00KXNO, Type 3260702 The communication card slots into the free interface on the PCB.	35 x 20 x 80	all units with control option KaControl -C1	196003260702
	Serial CANbus card	to increase the number of units in a single-circuit system from 7 to a maximum of 30 units, one required per unit, Extension of the cable length from the first to the last unit from 30 m to 500 m Can only be used with the KaControl configuration.	35 x 30 x 60	all units with control option KaControl -C1	196003260301
	Serial Modbus card	Required for each device for connection to KaControl panels or on-site Modbus networks. The communication card slots into the free interface on the PCB.	31 x 12 x 61	all units with control option KaControl -C1	196003260101

CONTINUED ▶

Accessories

Article	Article	Properties	Dimensions	Suitable for	Article no.
			[mm]		

Control accessories electromechanical 230 V

	Room temperature controller	Heating/Cooling, with setpoint display by means of arrow indicators, 24 V AC/DC, 0 - 10 V, 50 Hz, for heating or cooling mode, Surface-mounted, Protection class III, Protection class IP 30, Temperature setting range -13 - -29 °C, Colour similar to RAL 9010 pure white	77 x 79 x 26	for extract air side, 5 Katherm QE or Katherm HK 320 E Trench Technology	194000146928
	Room thermostat	Heating/Cooling, 2- and 4-pipe, 3-stage. Only in conjunction with valves/valve kits with actuator, 230 V AC, Open/Closed, with OFF/Manual/Automatic fan switch-over, Surface-mounted, Temperature setting range 5 - 30 °C, Colour similar to RAL 9010 pure white	110 x 111 x 26	EC units electromechanical, 5 Katherm HK Trench Technology, 2 TOP or Ultra Unit Heaters, 5 Venkon Fan Coils, 2 KaCool D AF, KaCool W or KaDeck Fan Coils	196000030155
	Climate Controller	Heating/Cooling, 2- and 4-pipe, Without Modbus, only with valves/valve kits, 230 V AC, Open/Closed, continuously variable, with LCD operating menu and integrated timer program, Surface-mounted, Colour similar to RAL 9010 pure white	78 x 140 x 15	EC units electromechanical, 4 Katherm HK Trench Technology, 2 KaCool D AF, KaCool W, Venkon or KaDeck Fan Coils	196000148941
	Climate Controller	Heating/Cooling, 2- and 4-pipe, Without Modbus, only with valves/valve kits, 230 V AC, Open/Closed, continuously variable, with LCD operating menu and integrated timer program, Surface-mounted, Colour similar to RAL 9004 signal black	78 x 140 x 15	EC units electromechanical, 4 Katherm HK Trench Technology, 2 KaCool D AF, KaCool W, Venkon or KaDeck Fan Coils	196000148942

Control accessories electromechanical 24 V





	Clock thermostat	Heating/Cooling, 2- and 4-pipe, only in conjunction with valves/valve kits, 24 V Actuator, Open/Closed, continuously variable, with LCD operating menu and integrated timer program, heating/cooling change-over by means of external potential-free contact (low voltage), flush-mounted, Protection class IP 30, Colour similar to RAL 9010 pure white	85 x 46 x 81	EC units, electromechanical 24 V/230 V, 5 Katherm HK or Katherm HK 320 E Trench Technology	196000030456
---	------------------	--	--------------	--	---------------------

CONTINUED ▶





Accessories

Article	Article	Properties	Dimensions [mm]	Suitable for	Article no.
---------	---------	------------	--------------------	--------------	-------------

Valve kits





	Valve kit	Heating/Cooling, 2-pipe, includes pre-adjustable valve, angled return shut-off valve, 24 V actuator, with an axial valve, pre-adjustable, and an angled return shut-off valve, Connection 1/2", supplied separately	150 x 120 x 250	for heating/cooling switch-over, with plug, Katherm HK	194000143211
	Valve kit	Heating/Cooling, 4-pipe, includes 2 pre-settable valves, 2 actuators, 1 straight and 1 angled return shut-off valve, 24 V actuator, with two axial valves, pre-settable, one angled return shut-off valve, one straight return shut-off valve, and two thermoelectric actuators 24 V, Connection 1/2", supplied separately	150 x 120 x 250	for heating/cooling switch-over, with plug, Katherm HK	194000143411
	Valve kit	Heating/Cooling, 2-pipe, 1 pre-adjustable valve, actuator, angled return shut-off valve, 24 V actuator, with an axial valve, pre-adjustable, and an angled return shut-off valve, Connection 1/2", supplied separately	150 x 120 x 250	Katherm HK, for higher flow from 250 l/h	194000143241
	Valve kit	Heating/Cooling, 4-pipe, 2 pre-settable valves, 2 actuators, 1 straight and angled return shut-off valve respectively, 24 V actuator, with two axial valves, pre-settable, one angled return shut-off valve, one straight return shut-off valve, and two thermoelectric actuators 24 V, Connection 1/2", supplied separately	150 x 120 x 250	Katherm HK, for higher flow from 250 l/h	194000143441

Valves and return shut-off valves

	Valve body	Axial, pre-settable, Connection 1/2"	51 x 33 x 114	Katherm NK 137/182 (trench heights 92 mm and 120 mm), Katherm HK	194000346911
	Valve body	Axial, pre-settable, kvs value = 2.6, Connection 1/2"	35 x 50 x 110	Katherm HK, for higher flow from 250 l/h	194000346914
	Pre-setting key	Once per project necessary.	20 x 20 x 60	pre-settable valve bodies, valve kits and convector connection kit	194000346915
	Pre-setting set		40 x 55 x 55	pre-settable valve bodies and valve kits with higher flow rate	194000346916

CONTINUED ▶

Accessories

Article	Article	Properties	Dimensions	Suitable for	Article no.
			[mm]		
	Return shut-off valve	Straight, Connection 1/2"	80 x 60 x 100	Katherm NK, Katherm QK or Katherm HK	194000145952
	Return shut-off valve	Angled, Connection 1/2"	22 x 50 x 73	Katherm HK	194000145953
	Return shut-off valve	straight, Connection 1/2"	62 x 35 x 95	Katherm HK, for higher flow from 250 l/h	194000145954
	Return shut-off valve	angled, Connection 1/2"	33 x 74 x 71	Katherm HK, for higher flow from 250 l/h	194000145955

Valve actuators

	Thermoelectric actuator	230 V AC	39 x 39 x 67	room thermostat type 30155 and climate controller type 14894x, Katherm NK	194000146905
		24 V AC/DC	64 x 40 x 79	Katherm, control configuration KaControl -C1 and clock thermostat type 30456, Katherm QK or Katherm HK 320 E	194000146906

CONTINUED ▶

Accessories

Article	Article	Properties	Dimensions [mm]	Suitable for	Article no.
---------	---------	------------	--------------------	--------------	-------------

Filter

	Filter for air inlet	Replacement filter without frame	130 x 4 x 415	Width 290 mm, Length 950 mm	143014316014
			130 x 8 x 325	Width 290 mm, Length 1200 mm	143014316019
			130 x 12 x 415	Width 290 mm, Length 1700 mm	143014316029
			130 x 16 x 350	Width 290 mm, Length 2000 mm	143014316035
			130 x 20 x 415	Width 290 mm, Length 2500 mm	143014316045
			130 x 24 x 375	Width 290 mm, Length 3000 mm	143014316055
			115 x 4 x 380	Width 245 mm and 320 mm, Length 915 mm	143014313013
			115 x 8 x 325	Width 245 mm and 320 mm, Length 1200 mm	143014313019
			115 x 12 x 380	Width 245 mm and 320 mm, Length 1700 mm	143014313029
			115 x 16 x 325	Width 245 mm and 320 mm, Length 2000 mm	143014313035
			115 x 20 x 380	Width 245 mm and 320 mm, Length 2500 mm	143014313045
			115 x 24 x 380	Width 245 mm and 320 mm, Length 3000 mm	143014313055
			160 x 4 x 400	Width 360 mm, Length 950 mm	143014321014
			160 x 4 x 660	Width 360 mm, Length 1200 mm	143014321019
			160 x 8 x 800	Width 360 mm, Length 1350 mm	143014321022
160 x 8 x 400	Width 360 mm, Length 1850 mm	143014321032			
160 x 8 x 800	Width 360 mm, Length 2250 mm	143014321040			

Condensate tray/pump

	Connection kit for condensation pump	230 V 50 Hz, supplied separately	200 x 100 x 400	Width 245 mm, Height 160 mm	194000143819
				Width 290 mm, Height 160 mm	194000143815
				width 320 mm, height 130 mm and width 360 mm, height 210 mm	194000143813
		230 V 50 Hz, factory-fitted		Width 245 mm, Height 160 mm	194000143820
				Width 290 mm, Height 160 mm	194000143816
				width 320 mm, height 130 mm and width 360 mm, height 210 mm	194000143814

Installation covers

	Installation cover	to protect trench during installation, factory-fitted, grilles are packed separately	230 x 18 x 1000	Width 245 mm	194000100245
			275 x 19 x 1000	Width 290 mm	194000100290
			305 x 19 x 1000	Width 320 mm	194000100320
			345 x 19 x 1000	Width 360 mm	194000100360



Kampmanngroup.com/katherm-hk

