



**LUXURY
RADIATORS**

CATALOGUE
ROOM AND BATHROOM
DESIGNER RADIATORS



luxrad.com

INDEX

ROOM RADIATORS

● EVEREST	8-9
● SAHARA	10-11
● ZEUS	12-13
● KOBE	14-15
● SPRING	16-17
● COLUMNUS	18-19
● REBUS	20-21
● PORTAL	22-23
● KOLIBER	24-25
● FORTUNA	26-27
● FORTUNA DOUBLE	28-29
● FARTT	30-31
● NIAGARA	32-33
● NIAGARA DOUBLE	34-35
● NIAGARA HORIZONTAL WITH A THERMOSTAT	36-37
● NIAGARA STANDARD COLOUR WITH COVER	38-39
● NIAGARA WITH STAINLESS STEEL COVER	40-41
● NIAGARA WITH TEMPERED GLASS COVER	42-43
● NIAGARA WITH MIRROR COVER	44-45
● NIAGARA GLASS COVER WITH GRAPHIC	46-49
● NIAGARA LED	50-51
● NIAGARA WITH A MIRROR	53-53
● SLIM LINE	54-55
● VITRO	56-57
● V-LINE	58-59
● PAUER	60-61
● DUCTOR	62-63
● KOBE FULL	64-65
● AURORA	66-67
● AURORA DOUBLE	68-69
● AURORA CORNER	70-71
● AURORA WITH A MIRROR	72-73
● TOBA	74-75
● TOBA DOUBLE	76-77
● CHEBBI	78-79

BATHROOM RADIATORS

● OPTIMUS	84-85
● ATRIA	86-87
● CALIDO	88-89
● NEBRASKA	90-91
● SCALA NEW	92-93
● NEO	94-95
● ATAKAMA	96-97
● FLAG BIS	98-99
● NEPTUN	100-101
● MODEL E	102-103
● MODEL E COVERED	104-105

● TYP E	106-107
● ELEGANT	108-109
● POLLUX	110-111
● GOCTA	112-113
● PIKO	114-115
● MERKURY	116-117
● JUPITER	118-119
● KASTOR	120-121
● SALTO	122-123
● SALTO MAX	124-125
● SALTO I	126-127
● OVALTIC	128-129
● OVALTIC COVER	130-131
● KILE	132-133
● MARS	134-135
● KWADRO	136-137
● ELIPSO	138-139
● BARVA	140-141
● GAJA	142-143
● SATURN	144-145
● REGULAR	146-147
● REGULAR-G	148-149

CHROME RADIATORS

● L1	152-153
● L2	154-155
● L4	156-157
● NIAGARA CHROME	158-159

STAINLESS STEEL RADIATORS

● EVEREST SN	162-163
● SAHARA SN	164-165
● MAKALU	166-167
● GOCTA SN	168-169
● PIKO SN	170-171
● ATRIA SN	172-173
● TOBA SN	174-175

EXAMPLES OF GRAFIC'S APPLICATIONS

● VALVES, HEATERS	178-180
-------------------	---------

● HEATERS, ACCESSORIES	181
------------------------	-----

● HANGERS	182-183
-----------	---------

● TYPES OF CONNECTIONS	184-185
------------------------	---------

● COLOURS	186-187
-----------	---------



Luxrad Polska Mazur i Wspólnicy Sp. J. has been producing heaters designed for general use for 20 years. It all began in 1996, when a production facility was established in Komorów near Warsaw. Since then the number of satisfied customers is growing steadily, both at home and abroad.

"To create the highest quality products, in accordance with modern design, ergonomics and safety" – this motto guides the company's owners: Przemysław Mazur and Jakub Monkiewicz.

Drawing on the experience gained in the European markets, we make every effort to ensure that LUXRAD products serve not only their primary heating function, but also become an important element of interior design. Every year we work on expanding our product range by adding new models, in accordance with the prevailing architecture and design trends. All heaters hold the certificates of conformity due to European norm PN – EN 442.

- our heaters are sold everywhere in Europe
- in production we use the highest quality materials and components
- we employ over 250 qualified employees
- we offer 6 years of warranty and possibility to extend it up to 8 years

LUXRAD heaters will suit various interior arrangements. We were the first to promote models in colors other than white. Today we offer heaters in special veneers imitating wood or stone. The unique design is a key aspect for us when designing new models. Following trends but also our customer's tastes, as the first Polish manufacturer, we used glass in the production of radiators.

We enable the purchase of a radiator with lighting. In addition, we implement individual projects of our clients. In addition, we carry on individual projects of our clients.

This catalogue was enriched with new products that correspond to current trends in design. You will find here a wide range of our radiators, made of various materials and available in many colours. We invite you to cooperate with us and read the content of our website at www.luxrad.com in search of perfect radiators for your home.

Yours faithfully,



Monkiewicz Jakub

Luxrad Polska Mazur i Wspólnicy Sp. J.



2 additional years
of warranty
when purchasing
valves

info@luxrad.com

3

SETTINGS



SETTINGS



6+2
WARRANTY

2 additional years
of warranty
when purchasing
valves

info@luxrad.com



ROOM RADIATORS

● EVEREST	8-9
● SAHARA	10-11
● ZEUS	12-13
● KOBE	14-15
● SPRING	16-17
● COLUMNUS	18-19
● REBUS	20-21
● PORTAL	22-23
● KOLIBER	24-25
● FORTUNA	26-27
● FORTUNA DOUBLE	28-29
● FARTT	30-31
● NIAGARA	32-33
● NIAGARA DOUBLE	34-35
● NIAGARA HORIZONTAL WITH A THERMOSTAT	36-37
● NIAGARA STANDAR COLOUR WITH COVER	38-39
● NIAGARA WITH STAINLESS STEEL COVER	40-41
● NIAGARA WITH TEMPERED GLASS COVER	42-43
● NIAGARA WITH MIRROR COVER	44-45
● NIAGARA GLASS COVER WITH GRAPHIC	46-49
● NIAGARA LED	50-51
● NIAGARA WITH A MIRROR	53-53
● SLIM LINE	54-55
● VITRO	56-57
● V-LINE	58-59
● PAUER	60-61
● DUCTOR	62-63
● KOBE FULL	64-65
● AURORA	66-67
● AURORA DOUBLE	68-69
● AURORA CORNER	70-71
● AURORA WITH A MIRROR	72-73
● TOBA	74-75
● TOBA DOUBLE	76-77
● CHEBBI	78-79

EVEREST



Height [mm]	Width [mm]	Collector Spacing [mm]	Depth [mm]	Space between wall and power slots [mm]	Radiator Weight [kg]	Radiator capacity [dm ³]	Power level [W] 55/45/20	Power level [W] 75/65/20	Power level [W] 90/70/20
600	1 BUSHING	500	136	61	2.6	0.35	41	79	99
900	1 BUSHING	800	136	61	3.8	0.52	60	115	144
1100	1 BUSHING	1000	136	61	4.6	0.65	72	140	176
1500	1 BUSHING	1400	136	61	6.2	0.87	89	173	217
1800	1 BUSHING	1700	136	61	7.3	1.05	104	204	256
2000	1 BUSHING	1900	136	61	8.1	1.17	115	226	284
2500	1 BUSHING	2400	136	61	10.8	1.47	142	282	354

width (amount of pipe bushings): 285(4), 360(5), 435(6), 510(7), 585(8), 660(9), 735(10), 810(11), 885(12), 960(13), 1035(14), 1110(15). Selected values for 1 pipe bushing

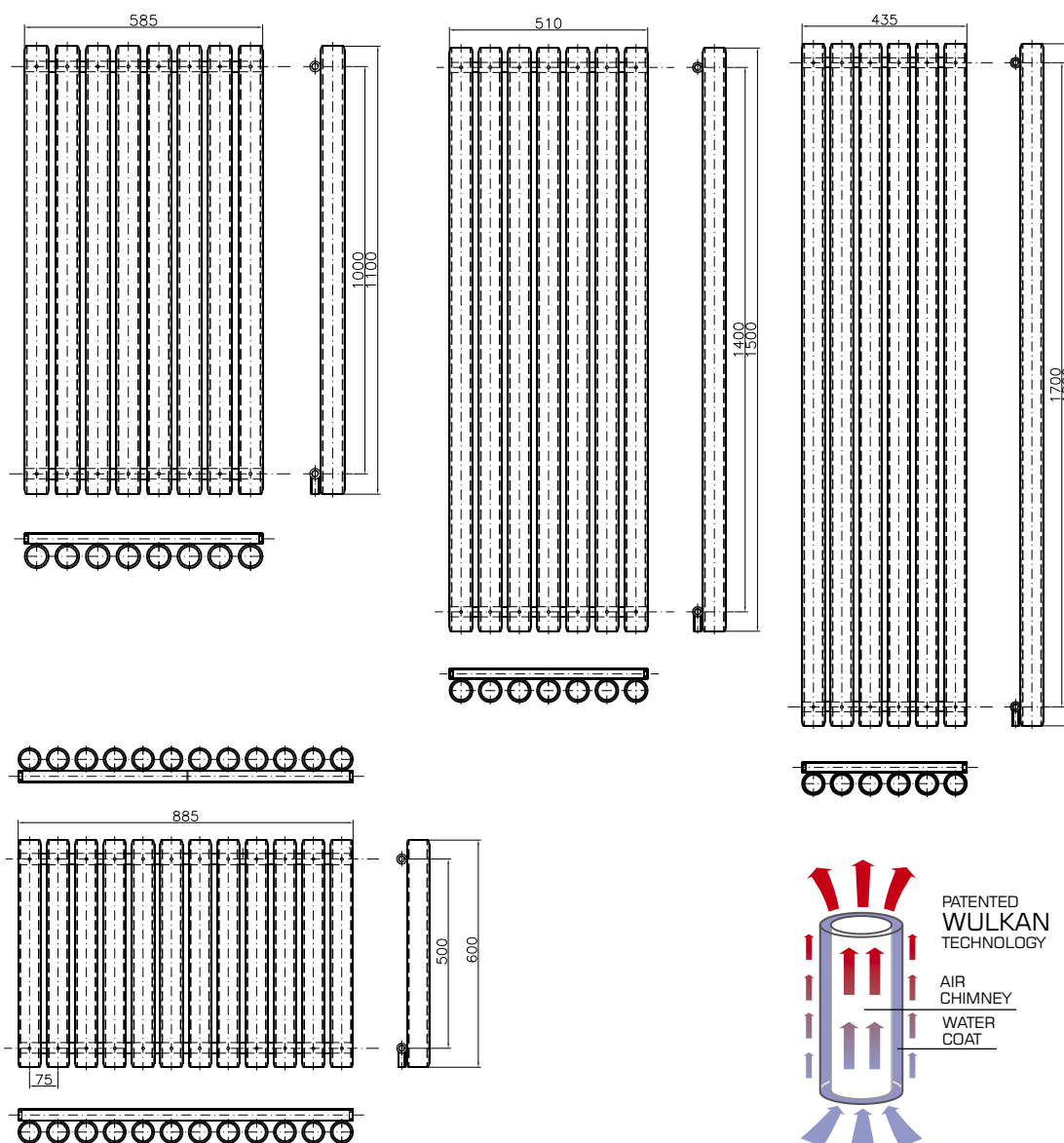

It is eye-catching

Everest oval shape surely draws attention. What is more important, however, is its high heat power output thanks to its specific design - made of single tubes in Wulkan technology - "pipe-in-pipe" in 60 mm diameter.



- › **Horizontal pipes:** round Ø 30
- › **Vertical pipes:** round Ø 60
- › **Detail work:** radiator made from low-carbon steel with powder coated finish on stainless steel
- › **Standard colours:** white RAL 9003 or anthracite RAL 7016
- › **Mounting:** mounting kit included
- › **Accessories:** radiator bracket enabling mounting to the division wall e.g. plasterboard with ease
- › **Further information:** non-standard size available to order



› **Types of connections:** page 184-185

› **Recommended valves kits** details on pages 178-179

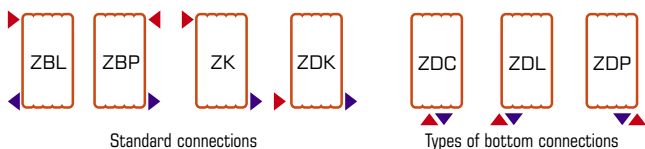

Axial valve



Straight valve



Angular valve



Combined valve

6+2
WARRANTY

2 additional years
of warranty
when purchasing
valves

info@luxrad.com

9

SAHARA



Height [mm]	Width [mm]	Collector Spacing [mm]	Depth [mm]	Space between wall and power slots [mm]	Radiator Weight [kg]	Radiator capacity [dm ³]	Power level [W] 55/45/20	Power level [W] 75/65/20	Power level [W] 90/70/20
600	1 BUSHING	500	106	61	0.94	0.11	16	32	40
900	1 BUSHING	800	106	61	1.41	0.17	24	47	59
1200	1 BUSHING	1100	106	61	1.88	0.23	33	64	80
1500	1 BUSHING	1400	106	61	2.36	0.29	40	79	99
1800	1 BUSHING	1700	106	61	2.83	0.34	48	95	119

width (amount of pipe bushings): 310(8), 390(10), 470(12), 550(14), 630(16), 710(18), 870(22), 1190(30).
 Selected values for 1 pipe bushing

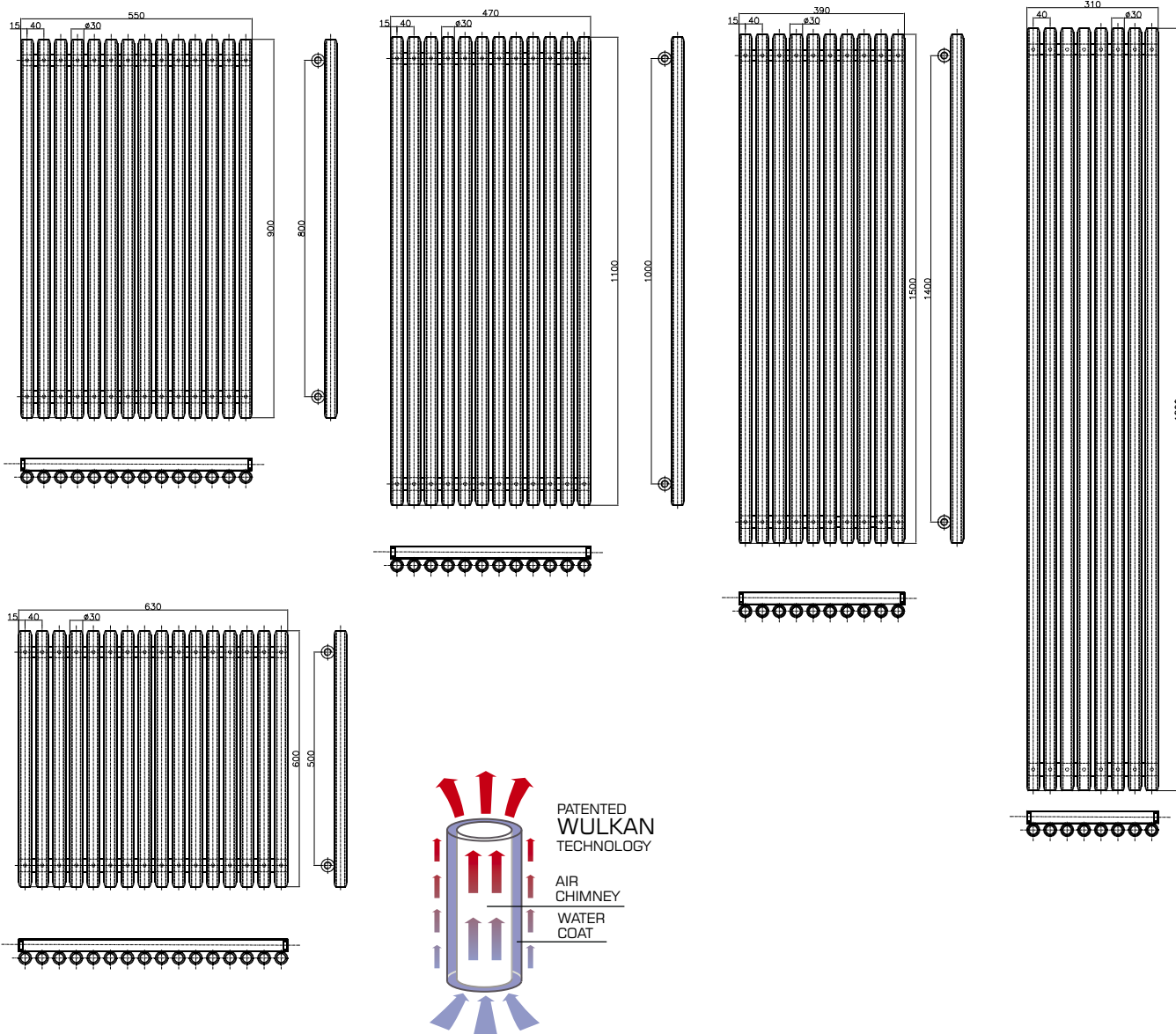

Ultimate heat emission

This product perfectly integrates an exceptional functionality in a beautiful design. Harmoniously formed cylinders 30 mm in diameter, truly satisfy aesthetic appetites.



- › **Horizontal pipes:** round Ø 30
- › **Vertical pipes:** round Ø 30
- › **Detail work:** radiator made from low-carbon steel with powder coated finish or stainless steel "INOX"
- › **Standard colours:** white RAL 9003 or anthracite RAL 7016
- › **Mounting:** mounting kit included
- › **Accessories:** radiator bracket enabling mounting to the division wall e.g. plasterboard with ease
- › **Further information:** non-standard size available to order



› **Types of connections:** page 184-185

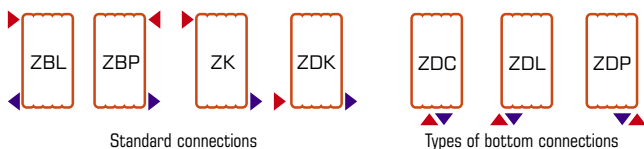

› **Recommended valves kits** details on pages 178-179

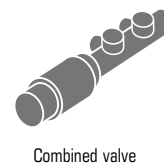

6+2
WARRANTY

2 additional years of warranty when purchasing valves

info@luxrad.com

11

ZEUS



Height [mm]	Width [mm]	Collector Spacing [mm]	Depth [mm]	Space between wall and power slots [mm]	Radiator Weight [kg]	Radiator capacity [dm ³]	Power level [W] 55/45/20	Power level [W] 75/65/20	Power level [W] 90/70/20
600	1 BUSHING	500	136	61	3.1	0.5	51	99	124
900	1 BUSHING	800	136	61	4.7	0.8	75	146	183
1100	1 BUSHING	1000	136	61	5.7	0.9	94	183	230
1500	1 BUSHING	1400	136	61	7.8	1.3	123	240	301
1800	1 BUSHING	1700	136	61	9.4	1.5	146	287	361
2000	1 BUSHING	1900	136	61	10.4	1.7	161	318	400

width (amount of pipe bushings): 285(4), 360(5), 435(6), 510(7), 585(8), 660(9), 735(10), 810(11), 885(12), 960(13), 1035(14), 1110(15). Selected values for 1 pipe bushing

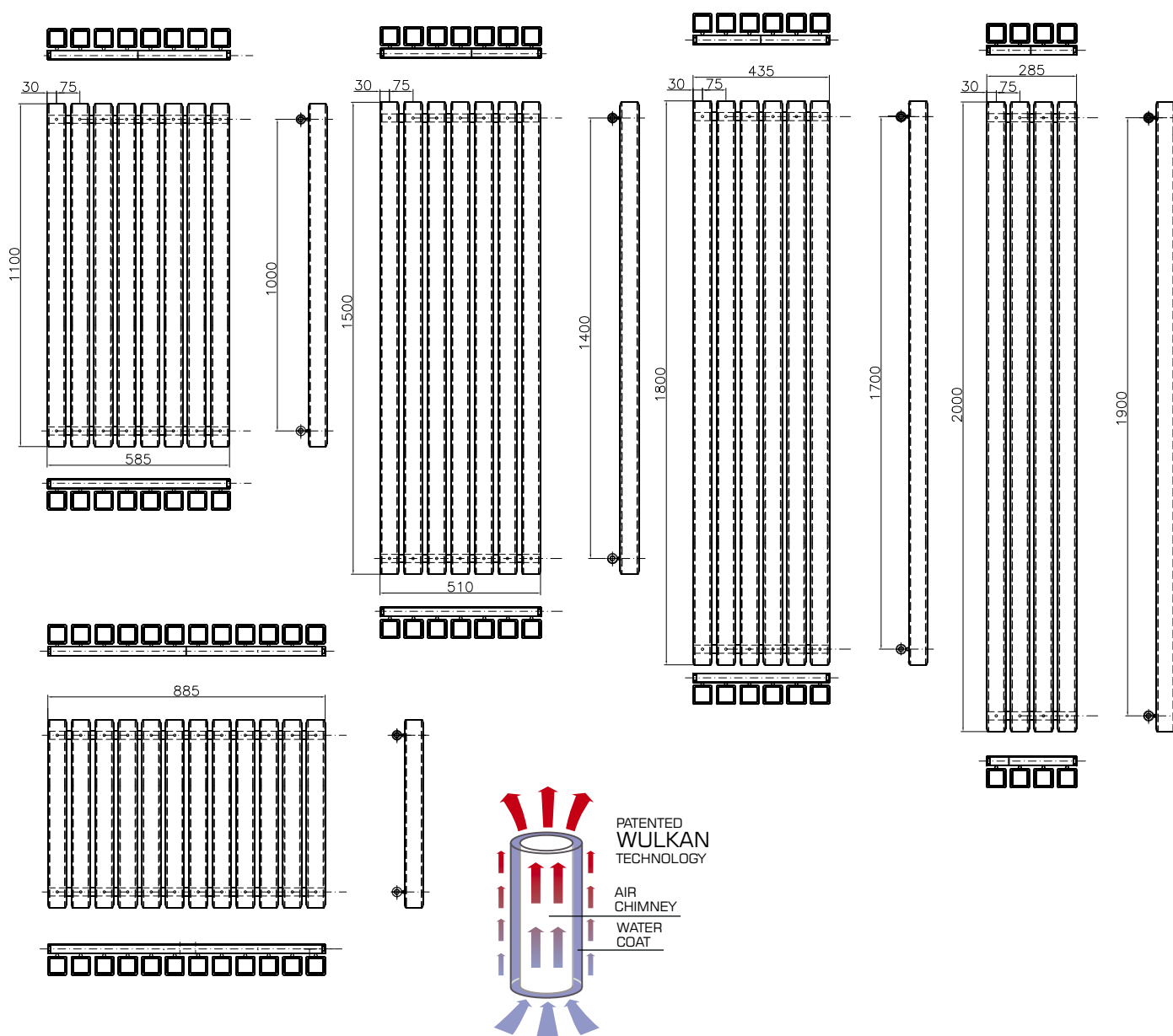

Unusual effect

ZEUS radiators draw attention through their interesting design coupled with high efficiency. Solid square pipes used, characteristics for this product, allow for a truly aesthetic fitting in any room.



- **Horizontal pipes:** round Ø 30
- **Vertical pipes:** square 60 x 60 mm
- **Detail work:** radiator made from low-carbon steel with powder coated finish
- **Standard colours:** white RAL 9003 or anthracite RAL 7016
- **Mounting:** mounting kit included
- **Accessories:** radiator bracket enabling mounting to the division wall e.g. plasterboard with ease
- **Further information:** non-standard size available to order



➤ **Types of connections:** page 184-185

➤ **Recommended valves kits** details on pages 178-179

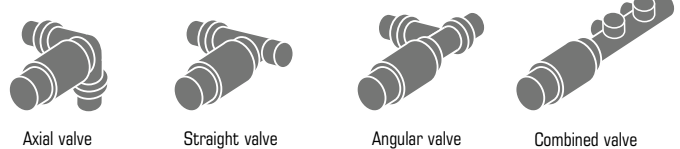
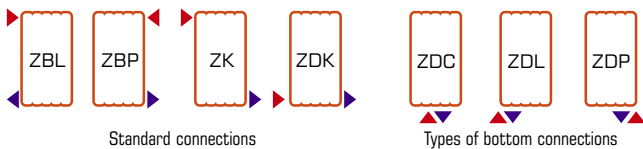

6+2
WARRANTY

2 additional years
of warranty
when purchasing
valves

Height [mm]	Width [mm]	Collector Spacing [mm]	Depth [mm]	Space between wall and power slots [mm]	Radiator Weight [kg]	Radiator capacity [dm ³]	Power level [W] 55/45/20	Power level [W] 75/65/20	Power level [W] 90/70/20
600	1 BUSHING	500	106	61	1.17	0.2	21	42	52
900	1 BUSHING	800	106	61	1.76	0.3	31	62	77
1100	1 BUSHING	1000	106	61	2.15	0.36	41	81	101
1500	1 BUSHING	1400	106	61	2.93	0.49	51	101	127
1800	1 BUSHING	1700	106	61	3.51	0.59	62	121	152

width (amount of pipe bushings): 310(8), 390(10), 470(12), 550(14), 630(16), 710(18), 870(22), 1190(30).
 Selected values for 1 pipe bushing

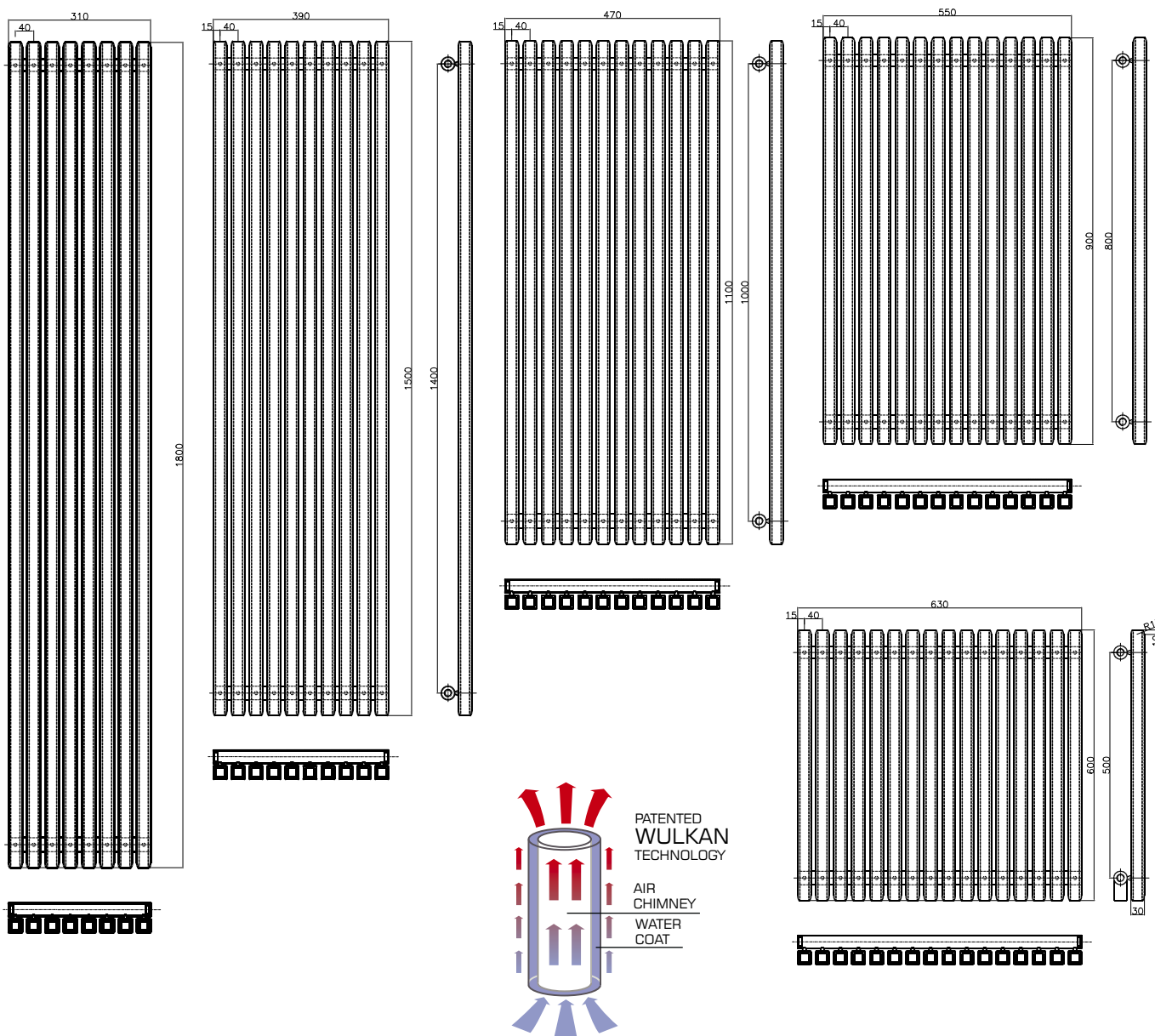

Square and modern

This is how KOBE product appears in a square form. 30 mm square profiles coupled with an innovative construction create a radiator, which can be mounted in any surroundings. Moreover, the figures for heating efficiency really speak for themselves.



- › **Horizontal pipes:** round Ø 30
- › **Vertical pipes:** square 30 x 30 mm
- › **Detail work:** radiator made from low-carbon steel with powder coated finish
- › **Standard colours:** white RAL 9003 or anthracite RAL 7016
- › **Mounting:** mounting kit included
- › **Accessories:** radiator bracket enabling mounting to the division wall e.g. plasterboard with ease
- › **Further information:** non-standard size available to order



Electric version available



Hydro-electric version available

› **Types of connections:** page 184-185

› **Recommended valves kits** details on pages 178-179

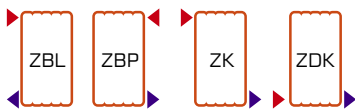

Standard connections



Types of bottom connections



Axial valve



Straight valve



Angular valve

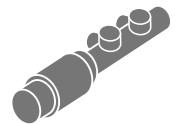

Combined valve

6+2
WARRANTY

2 additional years of warranty when purchasing valves

info@luxrad.com

15

SPRING



Height [mm]	Width [mm]	Collector Spacing [mm]	Depth [mm]	Space between wall and power slots [mm]	Radiator Weight [kg]	Radiator capacity [dm ³]	Power level [W] 55/45/20	Power level [W] 75/65/20	Power level [W] 90/70/20
SPRING 1									
1050	300	50	122	3	17.4	2.2	215	406	510
1050	400	50	122	4	23.1	2.9	287	542	681
1050	500	50	122	5	28.8	3.7	359	677	851
1450	300	50	122	3	24	3	297	561	705
1450	400	50	122	4	31.9	4.1	396	748	940
1450	500	50	122	5	39.8	5.1	495	935	1176
1750	300	50	122	3	29.1	3.7	366	690	868
1750	400	50	122	4	38.7	4.9	488	920	1157
1750	500	50	122	5	48.4	6.1	610	1151	1447
SPRING 2									
1050	115	50	135	1	11.6	1.5	115	216	271
1050	300	50	135	2	17.9	2.3	229	431	542
1050	400	50	135	3	26.9	3.4	342	646	812
1450	115	50	135	1	15.2	1.9	158	298	374
1450	300	50	135	2	25.3	3.2	315	595	748
1450	400	50	135	3	37	4.8	473	893	1123
1750	115	50	135	1	17.9	2.3	194	366	460
1750	300	50	135	2	30.4	3.9	388	733	922
1750	400	50	135	3	45.7	5.8	582	1099	1382

SPRING 2"

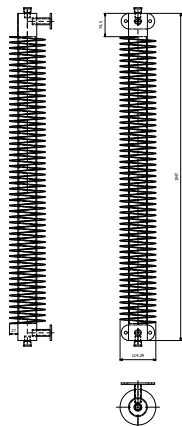

SPRING 2"

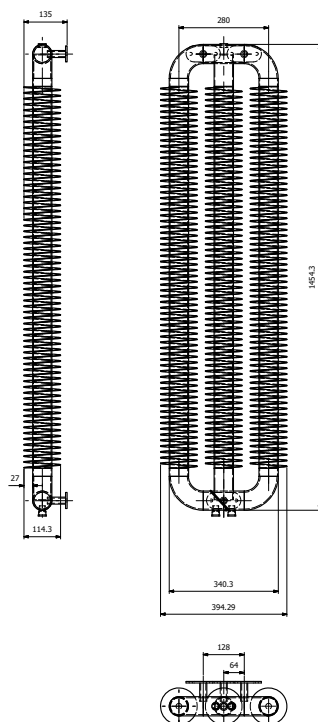

SPRING 1"

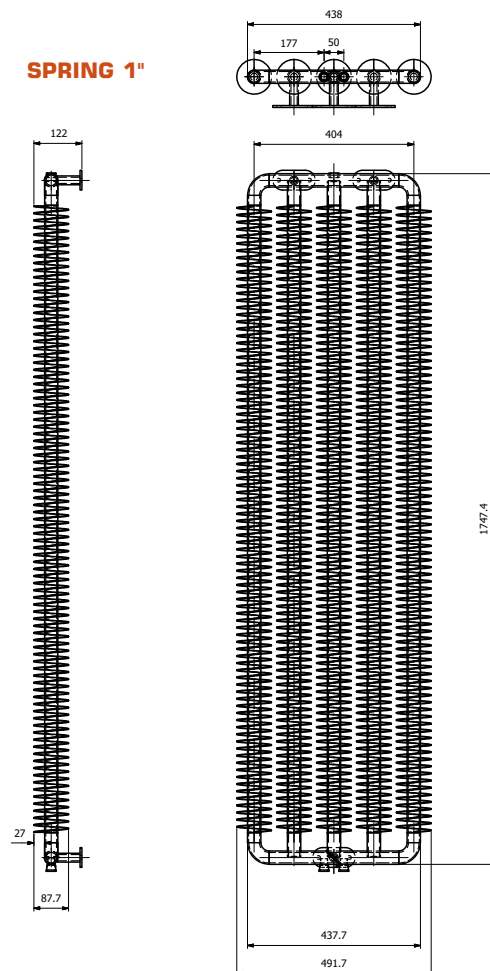

SPRING



Unique design

Heater characterized by a slim appearance. Wave shape around a pipe adds character to it. Thanks to this connection, heater will meet the most demanding expectations. Available horizontal and vertical.

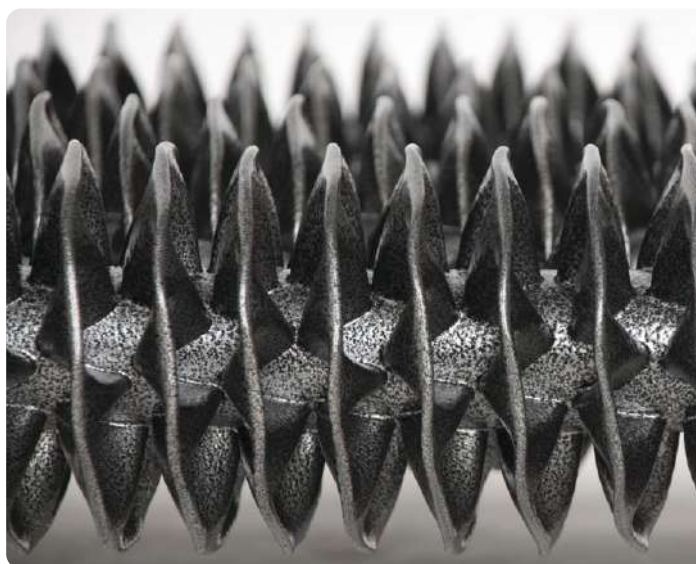

- › **Vertical pipes:** round
- › **Horizontal pipes:** 1" or 2" with ribs
- › **Detail work:** low-carbon steel, powder coated finish
- › **Standard colours:** white RAL 9003, anthracite RAL 7016
- › **Mounting:** mounting kit included

Horizontal version available only for a single-pipe radiator



Horizontal version available



Warranty



Maximum temperature



Maximum work pressure

› **Types of connections:** page 184-185



Standard connections

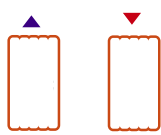

one-pipe version

› **Recommended valves kits** details on pages 178-179



Axial valve



Straight valve



Angular valve



Combined valve

6+2
WARRANTY

2 additional years of warranty when purchasing valves

info@luxrad.com

17

COLUMNUS



Classic with modernity

Radiators from the Columnus series are characterised by a combination of classic and modernity. Thanks to their rounded shapes, they can be used in any interior. The modular structure gives a wide range of arrangement possibilities. Going further, we can also choose any color using the RAL template and the LUXRAD special color palette.



- › **Vertical elements:** columnar, 2- and 3-pipe
- › **Construction:** low carbon steel, powder coated
- › **Standard colour:** RAL 9010 white
- › **Mounting brackets:** included with the radiator
- › **The radiator may be finished in a colourless finish.**



› **Types of connections:** page 184-185

› **Recommended valves kits** details on pages 178-179

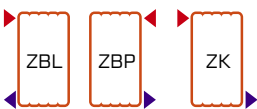

Rodzaje podłączeń



Types of bottom connections



Axial valve



Straight valve



Angular valve

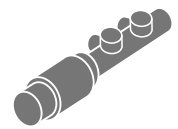

Combined valve

6+2
WARRANTY

2 additional years
of warranty
when purchasing
valves

info@luxrad.com

19

REBUS



Height [mm]	Width [mm]	Collector Spacing [mm]	Depth [mm]	Space between wall and power slots [mm]	Radiator Weight [kg]	Radiator capacity [dm ³]	Power level [W] 55/45/20	Power level [W] 75/65/20	Power level [W] 90/70/20
REBUS									
1030	485	50	87	53	29.5	3.7	187	352	442
1530	485	50	87	53	43.6	5.3	279	527	662
1830	485	50	87	53	52.3	6.3	335	633	796
REBUS II									
1030	485	50	91	47	39.7	6.9	327	616	774
1530	485	50	91	47	60.3	10.2	489	923	1161
1830	485	50	91	47	72.3	12.1	587	1107	1392

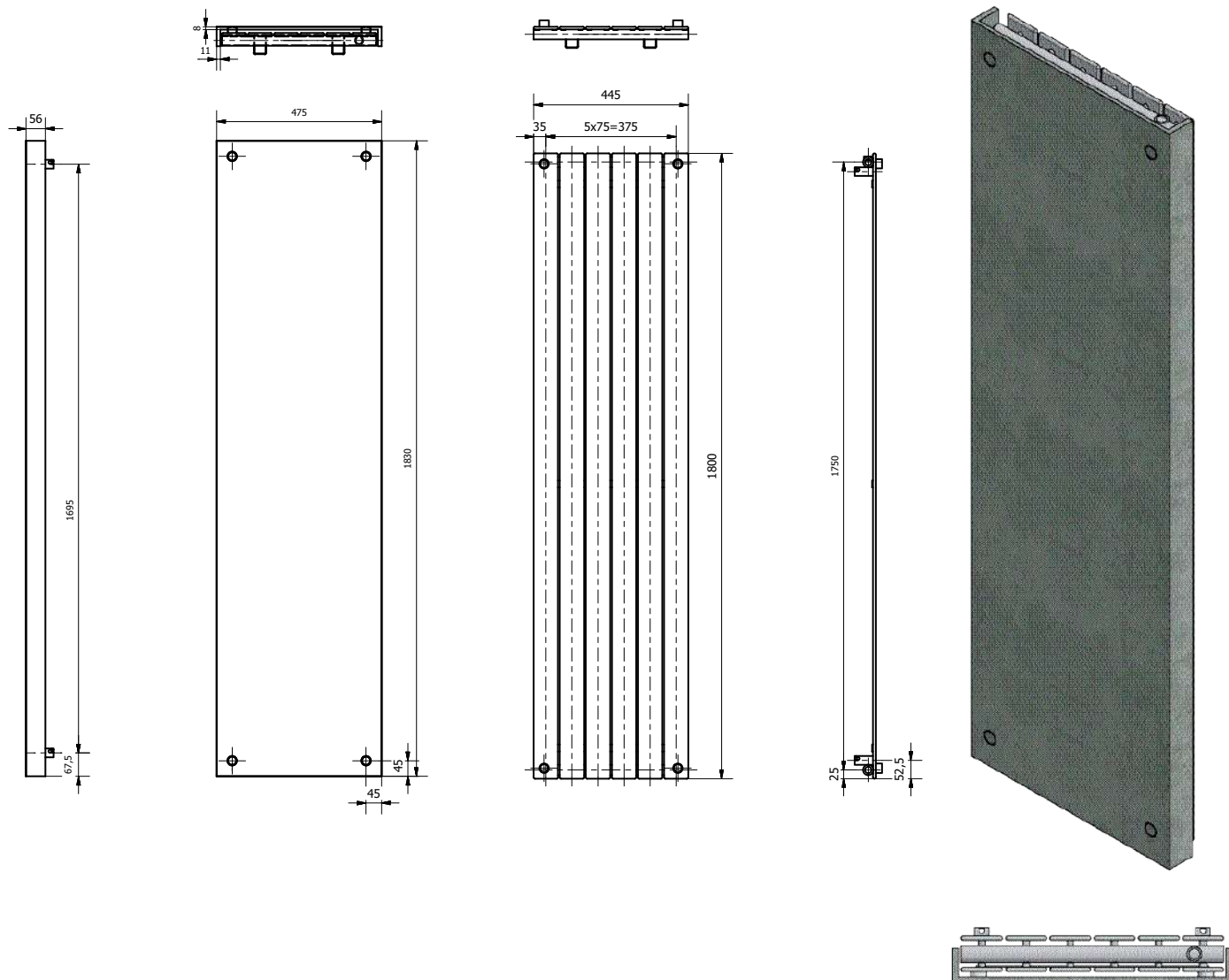

REBUS



Concrete heater in industrial style

Heater, whose main trump is its architectural concrete housing. It's simple in design, relying only on proportions, colour and the material's texture. Additionally, while keeping a low weight, its durability and stiffness has good heat accumulation properties. Available singular and dual.



- › **Horizontal pipes:** round \varnothing 30
- › **Vertical panels:** rectangular 8 x 70 mm
- › **Housing:** architectural concrete mounted to the heater
- › **Detail work:** low-carbon steel, powder coated finish, housing – architectural concrete 8 mm
- › **Standard colours:** white, grey, black
- › **Mounting:** mounting kit included
- › **Other informations:** non-standard sizes available to order

Due to the properties of the material used (concrete) the actual colour may vary from the one shown in the photo.



Warranty



Maximum temperature

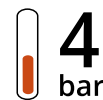

Maximum work pressure

› **Types of connections:** page 184-185



Standard connections



Types of bottom connections

› **Recommended valves kits** details on pages 178-179



Axial valve



Straight valve



Angular valve

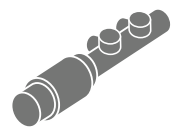

Combined valve

6+2
WARRANTY

2 additional years
of warranty
when purchasing
valves

info@luxrad.com

21

PORTAL



Height [mm]	Width [mm]	Collector Spacing [mm]	Depth [mm]	Space between wall and power slots [mm]	Radiator Weight [kg]	Radiator capacity [dm ³]	Power level [W] 55/45/20	Power level [W] 75/65/20	Power level [W] 90/70/20
1500	500	50	104-114	66-76	26.4	6.2	396	747	939
1800	500	50	104-114	66-76	31.7	7.45	474	895	1125

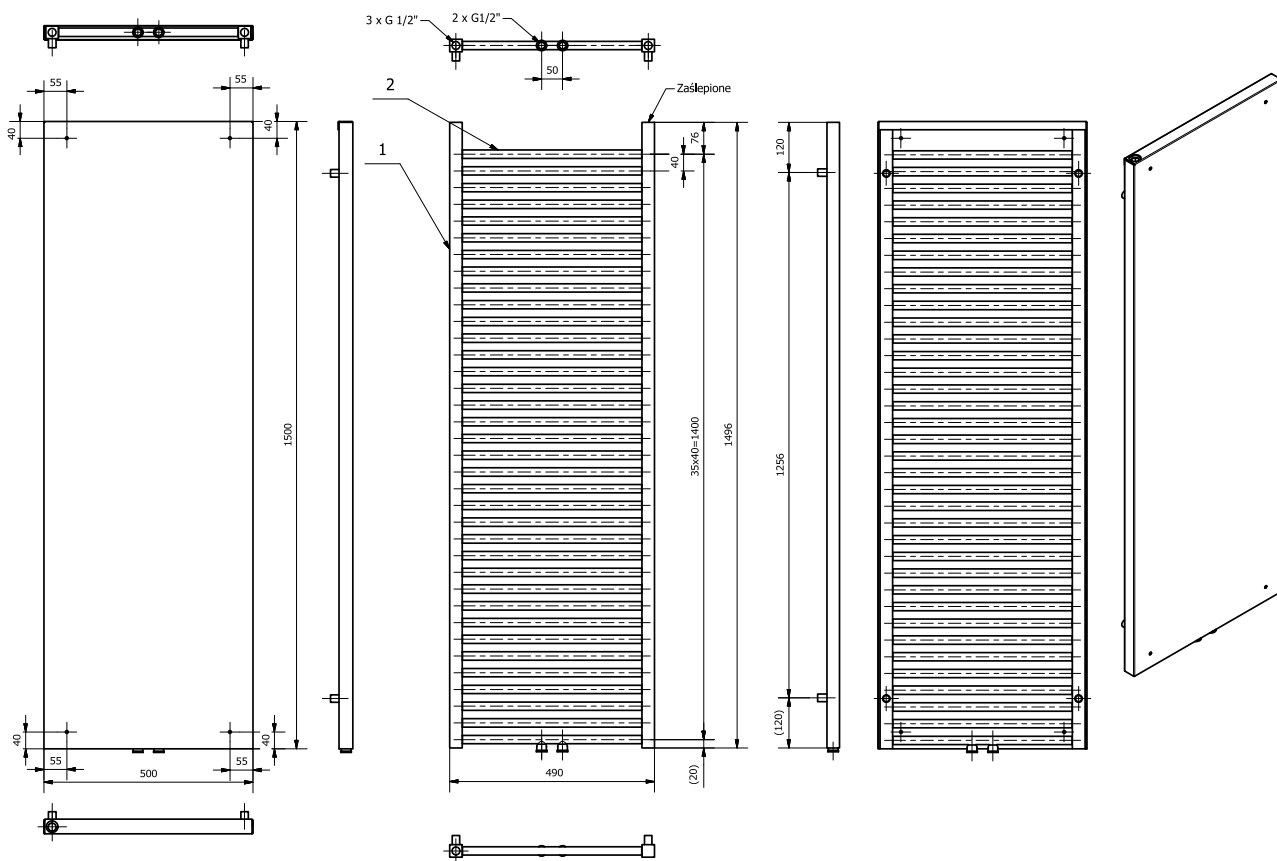

PORTAL



Depth effect

PORTAL – a novelty in our offer. This heater was created for modern interiors, where the decorative element is also to make an impression. Steel construction is combined with a mirror, which gives an effect of depth. The mirror is equipped with LED lighting, to which a remote control is attached. This allows us to set a color that is most suitable for us at the given moment. The heater will work both in the living room, corridor and bathroom. By combining several functions in one product we also save room, which is ideal for small spaces.



- › **Horizontal pipes:** square 30 x 30 mm
- › **Vertical pipes:** round Ø 20 mm
- › **Cover:** 4 mm mirror with LED backlight
- › **Detail work:** radiator made from low-carbon steel with powder coated finish
- › **Housing colour:** RAL 9005 MAT
- › **Other information:** possibility to produce non-standard dimensions, RGB LED tape in the set with 220 V power supply and wireless controller. 2-year warranty for the LED strip



Warranty



Maximum temperature



Electric version available



Hydro-electric version available



Maximum work pressure

› **Types of connections:** page 184-185



Standard

› **Recommended valves kits** details on pages 178-179



Axial valve



Straight valve



Angular valve

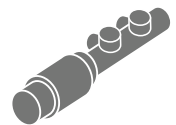

Combined valve

6+2
WARRANTY

2 additional years
of warranty
when purchasing
valves

info@luxrad.com

23

KOLIBER



Height [mm]	Width [mm]	Collector Spacing [mm]	Depth [mm]	Radiator Weight [kg]	Radiator capacity [dm ³]	Power level [W] 55/45/20	Power level [W] 75/65/20	Power level [W] 90/70/20
1500	317 (340)	383	275	16.1	2	348	656	825
1600	317 (340)	383	275	17	2.16	367	693	871
1700	317 (340)	383	275	17.9	2.28	388	731	919

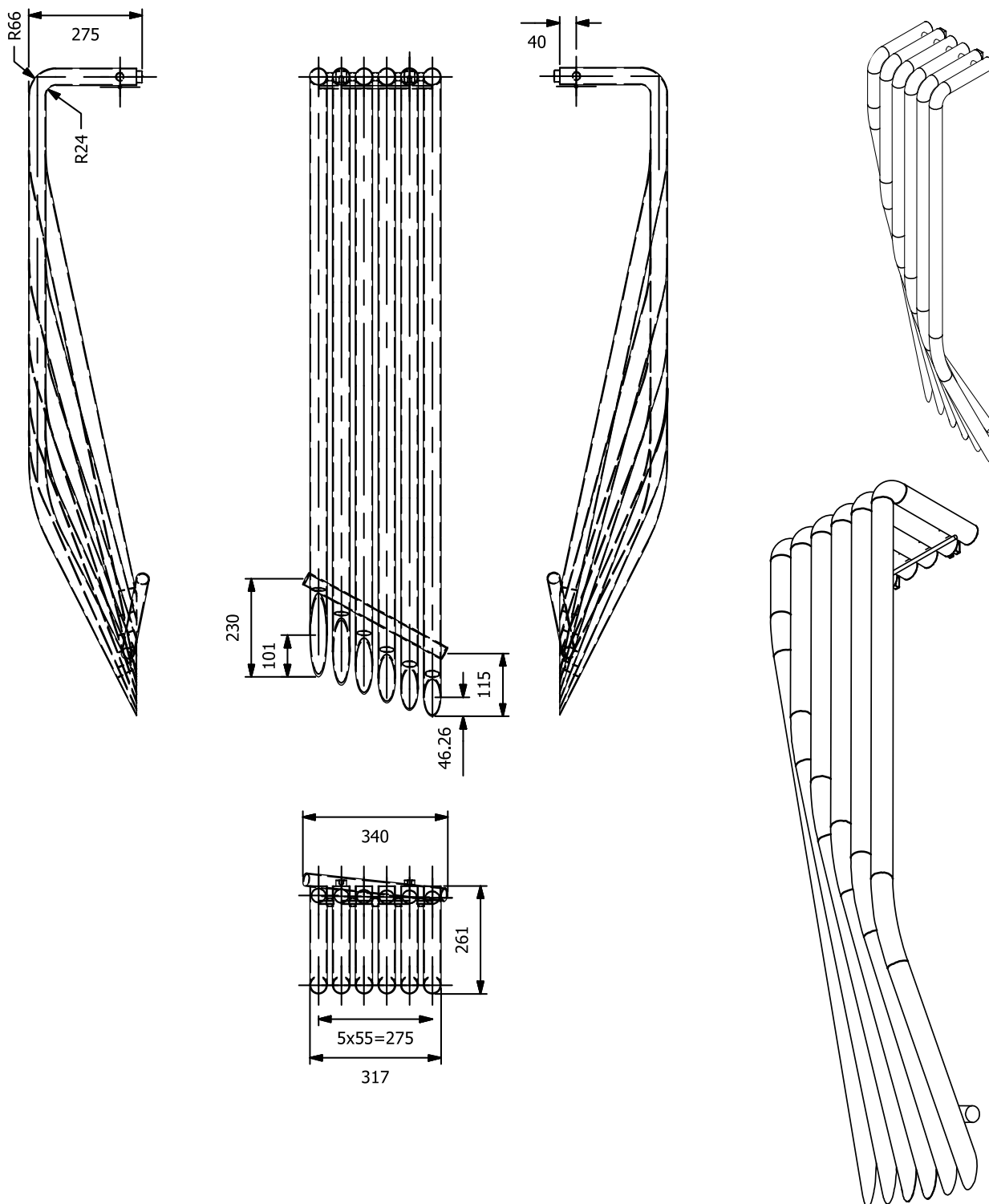

Heater of a new generation

Exceptional functionality and unique design inspired by nature. Irregular shape of pipes gives optical illusion that makes it look like on each side it takes a completely different form. It will perfectly fit in simply designed indoors as well as in those designed with more creativity.



- › **Pipes:** round Ø 30mm
- › **Vertical pipes:** round Ø 42mm
- › **Detail work:** low-carbon steel, powder coated finish
- › **Standard colours:** white RAL 9003 or anthracite RAL 7016
- › **Mounting:** mounting kit included

KOLIBER

design by
Drezner Dominika



› **Recommended valves kits** details on pages 178-179

› **Types of connections:** page 184-185



Standardowe



Angular valve

6+2
WARRANTY
2 additional years
of warranty
when purchasing
valves

info@luxrad.com

25

FORTUNA



Height [mm]	Width [mm]	Collector Spacing [mm]	Depth [mm]	Space between wall and power slots [mm]	Radiator Weight [kg]	Radiator capacity [dm ³]	Power level [W] 55/45/20	Power level [W] 75/65/20	Power level [W] 90/70/20
600	468	550	99	61	6.88	4.4	190	359	451
600	584	550	99	61	8.59	5.5	238	449	564
600	816	550	99	61	12.03	7.7	333	628	790
600	990	550	99	61	14.6	9.4	405	763	959
600	1164	550	99	61	17.18	11	453	854	1074
1000	236	950	99	61	5.3	3.5	150	286	359
1000	352	950	99	61	8	5.2	225	429	539
1000	410	950	99	61	9.4	6.1	262	500	629
1000	468	950	99	61	10.77	7	300	572	719
1000	584	950	99	61	13.46	8.7	375	715	899
1000	642	950	99	61	14.8	9.5	412	786	988
1500	236	1450	99	61	7.82	5.1	219	416	523
1500	352	1450	99	61	11.73	7.7	329	625	786
1500	410	1450	99	61	13.6	8.9	384	729	917
1500	468	1450	99	61	15.64	10.2	439	833	1047
1500	584	1450	99	61	19.54	12.8	548	1041	1309
1500	642	1450	99	61	21.5	14.1	603	1145	1440
1800	236	1750	99	61	9.28	6.1	258	494	621
1800	352	1750	99	61	13.92	9.1	388	742	933
1800	410	1750	99	61	16.24	10.6	452	865	1088
1800	468	1750	99	61	18.56	12.2	517	989	1244
1800	584	1750	99	61	23.19	15.2	647	1236	1554
1800	642	1750	99	61	25.5	16.8	712	1360	1710
2000	236	1950	99	61	10.3	6.7	285	547	688
2000	352	1950	99	61	15.4	10	427	820	1031
2000	410	1950	99	61	18	11.7	498	956	1202
2000	468	1950	99	61	20.6	13.5	569	1093	1374
2000	584	1950	99	61	25.7	16.8	711	1366	1718
2000	642	1950	99	61	28.3	18.6	783	1503	1890

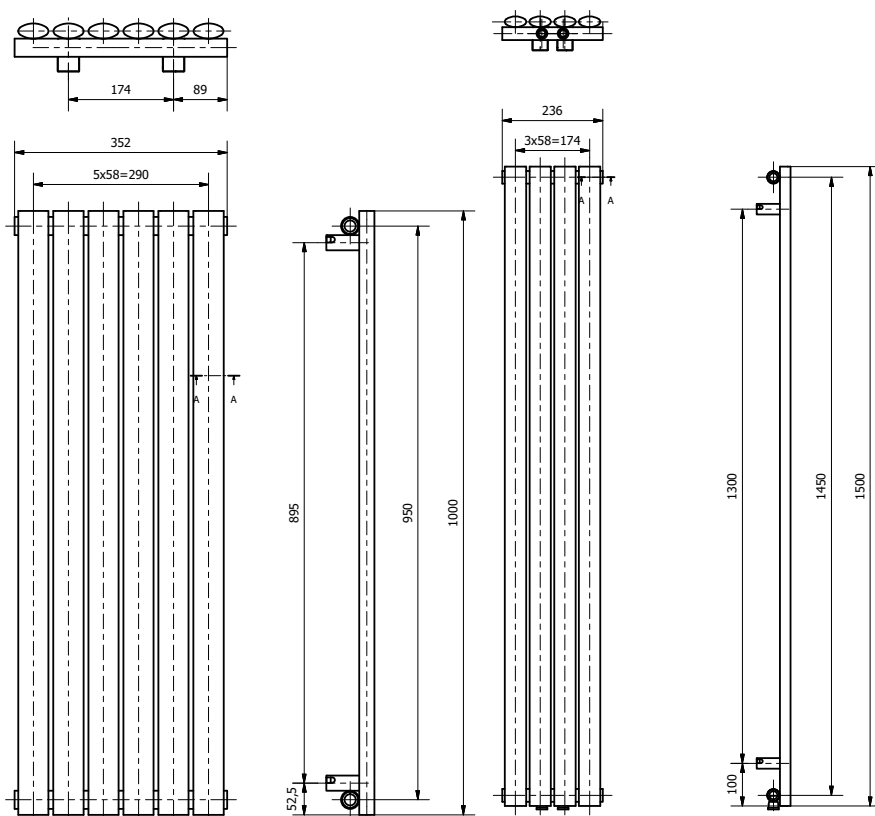

**Horizontal version:
H - Width
B - Height**

**In horizontal version
50 mm connections
are unavailable.**

FORTUNA



Slim and tough

Elliptic shape of FORTUNA radiator follow modern trends. Main advantage of this model is possibility of using it in case of high water pressure. FORTUNA will fit perfectly in any kind of room.



- › **Horizontal pipes:** round Ø 30
- › **Vertical pipes:** elliptic 25 x 50 mm
- › **Detail work:** radiator made from low-carbon steel with powder coated finish
- › **Standard colours:** white RAL 9003 or anthracite RAL 7016
- › **Mounting:** mounting kit included
- › **Accessories:** radiator bracket enabling mounting to the division wall e.g. plasterboard with ease
- › **Further information:** non-standard size available to order. In horizontal version ZDC unavailable



› **Types of connections:** page 184-185

› **Recommended valves kits** details on pages 178-179

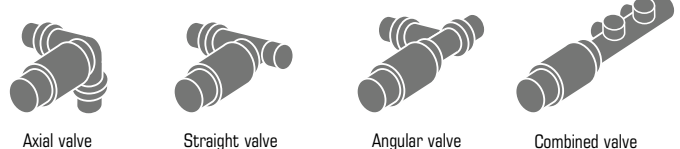
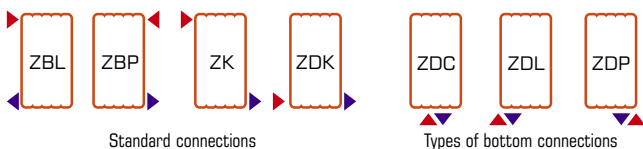

6+2
WARRANTY

2 additional years
of warranty
when purchasing
valves

info@luxrad.com

27

FORTUNA DOUBLE



Height [mm]	Width [mm]	Collector Spacing [mm]	Depth [mm]	Space between wall and power slots [mm]	Radiator Weight [kg]	Radiator capacity [dm ³]	Power level [W] 55/45/20	Power level [W] 75/65/20	Power level [W] 90/70/20
600	468	550	99	61	12.72	8.3	284	524	659
600	584	550	99	61	15.89	10.4	340	625	786
600	816	550	99	61	22.25	14.5	437	812	1021
600	990	550	99	61	27.01	17.6	504	944	1187
600	1164	550	99	61	31.78	20.7	628	1186	1491
1000	236	950	99	61	10.2	6.7	266	495	622
1000	352	950	99	61	15.3	10	374	699	879
1000	410	950	99	61	17.9	11.7	425	797	1002
1000	468	950	99	61	20.5	13.4	476	893	1123
1000	584	950	99	61	25.63	16.8	570	1075	1352
1000	642	950	99	61	28.1	18.4	616	1164	1464
1500	236	1450	99	61	15.12	10	395	731	919
1500	352	1450	99	61	22.68	14.9	566	1051	1322
1500	410	1450	99	61	26.4	17.3	647	1205	1515
1500	468	1450	99	61	30.24	19.9	726	1355	1704
1500	584	1450	99	61	37.79	24.9	876	1640	2063
1500	642	1450	99	61	41.5	27.3	947	1777	2235
1800	236	1750	99	61	18.04	11.9	475	873	1098
1800	352	1750	99	61	27.06	17.8	684	1262	1587
1800	410	1750	99	61	31.57	20.8	783	1448	1821
1800	468	1750	99	61	36.07	23.8	879	1630	2050
1800	584	1750	99	61	45.09	29.7	1064	1980	2490
1800	642	1750	99	61	49.5	32.6	1151	2146	2699
2000	236	1950	99	61	20	13.2	529	967	1216
2000	352	1950	99	61	30	19.7	764	1402	1763
2000	410	1950	99	61	35	23.1	877	1612	2027
2000	468	1950	99	61	40	26.4	985	1815	2283
2000	584	1950	99	61	50.1	33	1191	2204	2772
2000	642	1950	99	61	55	36.2	1290	2392	3009

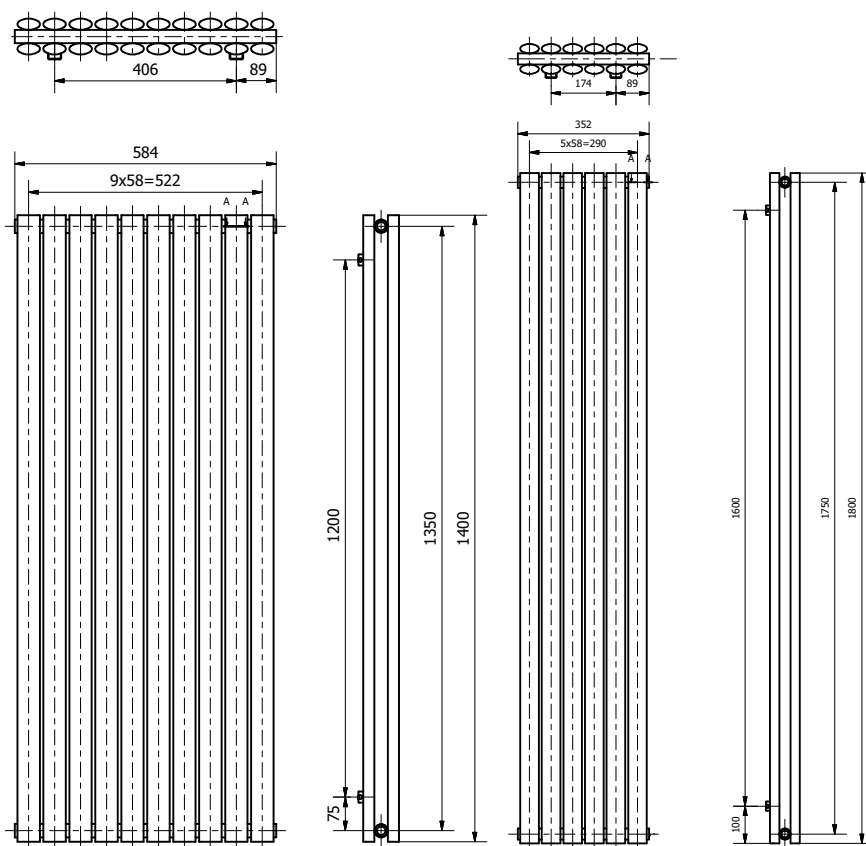

**Horizontal version:
H - Width
B - Height**

**In horizontal version
50 mm connections
are unavailable.**

FORTUNA DOUBLE



Durable and solid

FORTUNA double is tougher sister from Fortuna family. It can handle warm up for bigger interiors and will give them original design. Adapted for work in high pressure heating systems.



- › **Horizontal pipes:** round Ø 30
- › **Vertical pipes:** elliptic 25 x 50 mm
- › **Detail work:** radiator made from low-carbon steel with powder coated finish
- › **Standard colours:** white RAL 9003 or anthracite RAL 7016
- › **Mounting:** mounting kit included
- › **Accessories:** radiator bracket enabling mounting to the division wall e.g. plasterboard with ease
- › **Further information:** non-standard size available to order. In horizontal version ZDC unavailable.



› **Types of connections:** page 184-185

› **Recommended valves kits** details on pages 178-179

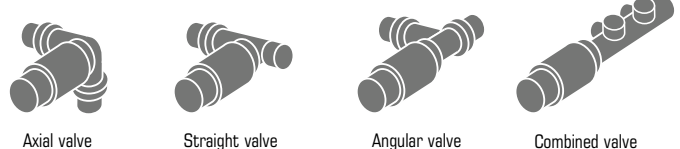
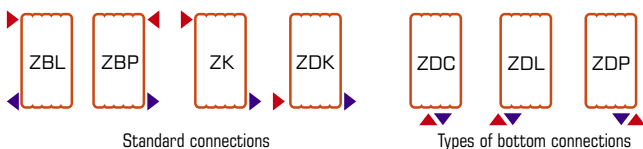

FARTT



Height [mm]	Width [mm]	Collector Spacing [mm]	Depth [mm]	Space between wall and power slots [mm]	Radiator Weight [kg]	Radiator capacity [dm ³]	Power level [W] 55/45/20	Power level [W] 75/65/20	Power level [W] 90/70/20
600	475	550	125	61	8.26	5.95	171	322	405
600	520	550	125	61	9.01	6.5	186	352	442
600	565	550	125	61	9.77	7.04	202	381	479
600	610	550	125	61	10.52	7.58	217	410	515
600	655	550	125	61	11.28	8.13	233	440	553
600	700	550	125	61	12.03	8.67	249	469	590
1200	430	1150	125	61	14.1	10.33	309	586	737
1200	475	1150	125	61	15.52	11.36	340	645	811
1200	520	1150	125	61	16.83	12.4	371	704	885
1200	565	1150	125	61	18.34	13.43	401	762	958
1200	610	1150	125	61	19.76	14.47	432	821	1032
1500	295	1450	125	61	12.06	8.89	268	513	645
1500	385	1450	125	61	15.52	11.43	345	660	830
1500	475	1450	125	61	18.98	13.98	422	806	1013
1500	565	1450	125	61	22.43	16.52	499	953	1198
1500	610	1450	125	61	24.16	17.79	537	1026	1290
1500	655	1450	125	61	25.89	19.07	575	1100	1383
1500	700	1450	125	61	27.62	20.34	614	1173	1475
1800	340	1750	125	61	16.55	12.19	364	704	885
1800	385	1750	125	61	18.62	13.72	409	792	996
1800	475	1750	125	61	22.77	16.77	500	968	1217
1800	565	1750	125	61	26.92	19.83	591	1144	1439
1800	610	1750	125	61	28.99	21.35	637	1232	1549
1800	655	1750	125	61	31.07	22.88	682	1320	1660
1800	700	1750	125	61	33.14	24.41	728	1408	1771

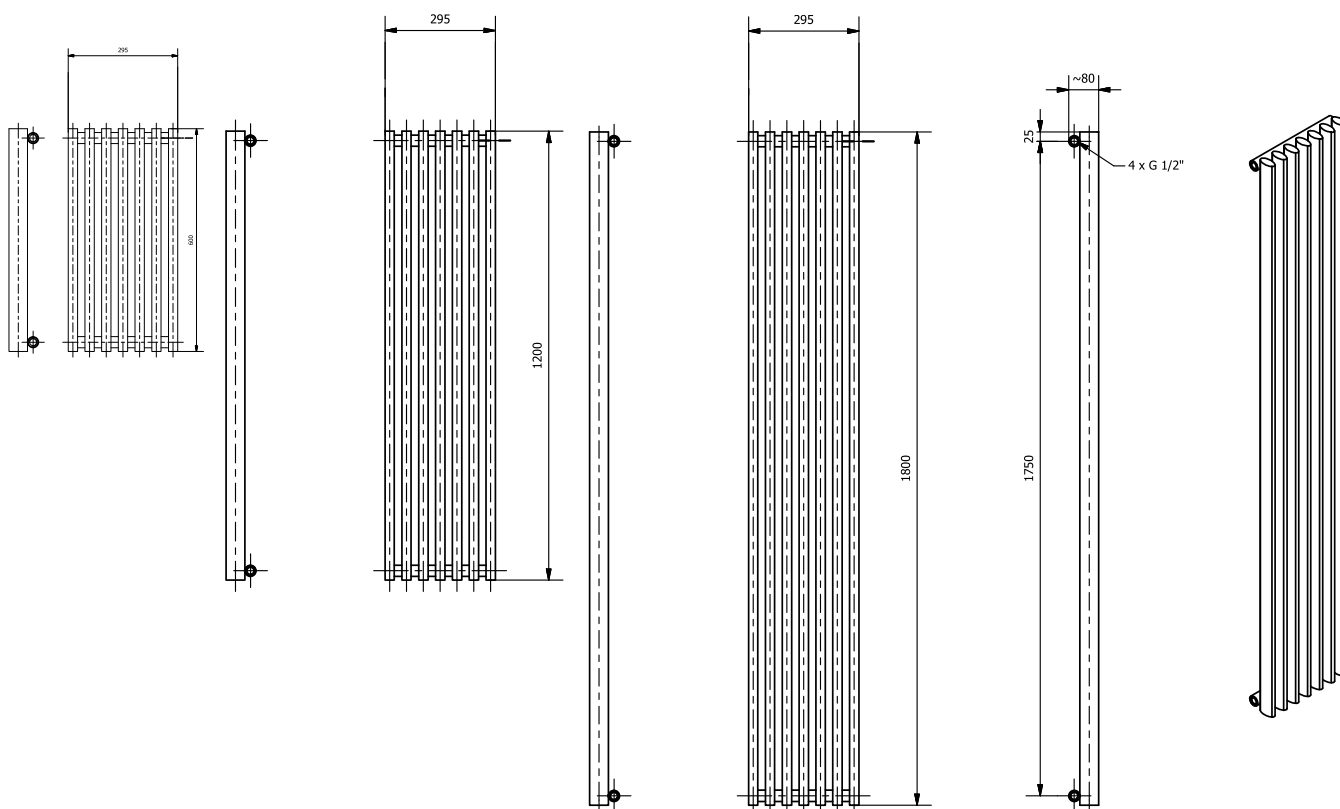

Extraordinary appearance

Fartt is a modern style radiator which is characterised by high power. It is built from vertical, elliptic pipes which makes it perfect for every interior.



- › **Horizontal pipes:** round Ø 30
- › **Vertical pipes:** elliptic 25 x 50 mm
- › **Detail work:** radiator made from low-carbon steel with powder coated finish
- › **Standard colours:** white RAL 9003 or anthracite RAL 7016
- › **Mounting:** mounting kit included
- › **Accessories:** radiator bracket enabling mounting to the division wall e.g. plasterboard with ease
- › **Further information:** non-standard size available to order. In horizontal version ZDC unavailable.



› **Types of connections:** page 184-185

› **Recommended valves kits** details on pages 178-179

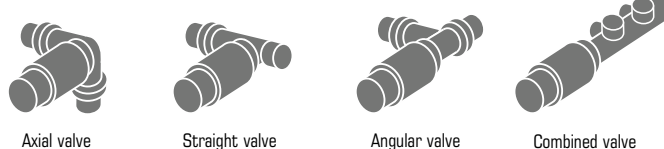
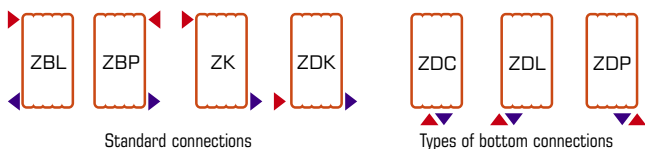

6+2
WARRANTY
2 additional years of warranty when purchasing valves

NIAGARA



Height [mm]	Width [mm]	Collector Spacing [mm]	Depth [mm]	Space between wall and power slots [mm]	Radiator Weight [kg]	Radiator capacity [dm ³]	Power level [W] 55/45/20	Power level [W] 75/65/20	Power level [W] 90/70/20
600	295	550	74	52	6.29	1.59	112	214	269
600	445	550	74	52	9.5	2.4	168	321	403
600	595	550	74	52	12.7	3.3	224	427	537
600	745	550	74	52	14.3	4.1	279	534	671
600	895	550	74	52	17.1	4.9	335	641	806
600	1045	550	74	52	19.9	5.7	392	748	940
1000	295	950	74	52	9.6	2.4	177	342	430
1000	445	950	74	52	14.5	3.7	267	513	645
1000	595	950	74	52	19.2	5	356	684	860
1000	745	950	74	52	23.9	6.2	446	855	1075
1000	895	950	74	52	28.6	7.5	534	1026	1290
1000	1045	950	74	52	33.3	8.7	600	1152	1449
1500	295	1450	74	52	13.65	3.5	263	500	629
1500	445	1450	74	52	20.6	5.3	394	749	942
1500	595	1450	74	52	27.4	7.1	525	999	1256
1500	745	1450	74	52	34.1	8.9	631	1202	1512
1500	895	1450	74	52	40.9	10.7	758	1442	1814
1500	1045	1450	74	52	47.7	12.5	884	1682	2115
1800	295	1750	74	52	16	4	310	593	745
1800	445	1750	74	52	24.3	6.3	465	891	1120
1800	595	1750	74	52	35.6	8.4	598	1143	1437
1800	745	1750	74	52	40.3	10.5	747	1428	1796
1800	895	1750	74	52	48.3	12.6	896	1714	2156
1800	1045	1750	74	52	56.2	16.2	1046	1999	2514
2000	295	1950	74	52	17.7	4.5	342	657	826
2000	445	1950	74	52	26.7	6.9	513	985	1239
2000	595	1950	74	52	44	9.3	659	1264	1590
2000	745	1950	74	52	44.4	11.6	823	1579	1986
2000	895	1950	74	52	53.2	13.9	988	1895	2383
2000	1045	1950	74	52	62	19.5	1153	2211	2781

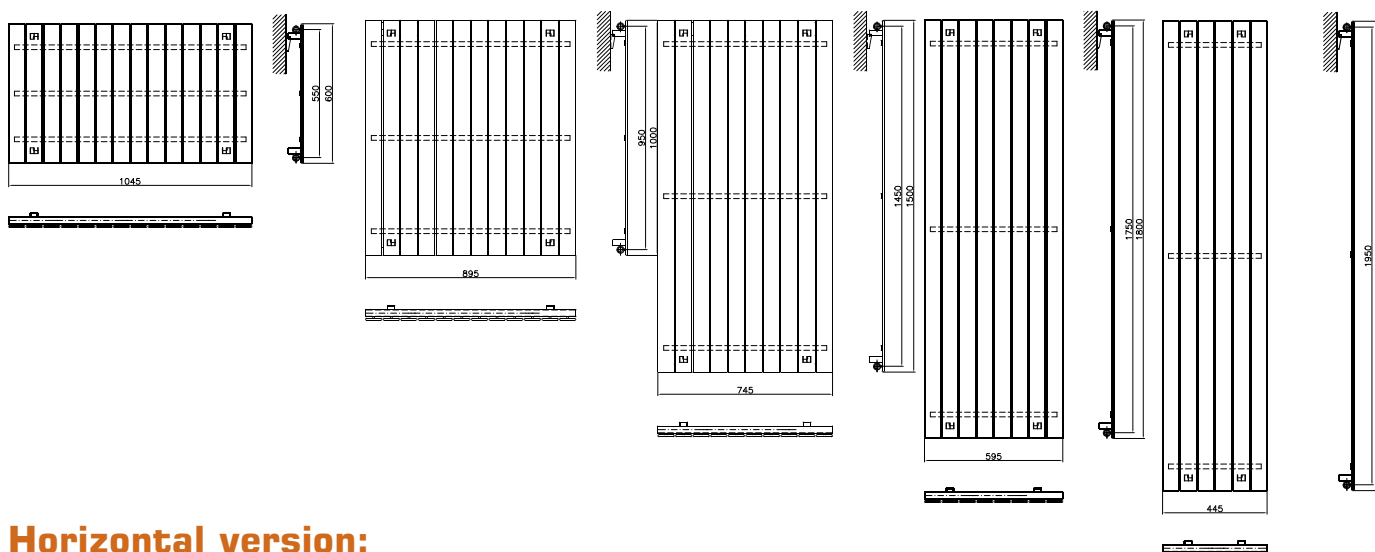

Horizontal version:
H - Width
B - Height

NIAGARA



Subtle charm

Thanks its flat, smooth design, this product presents itself as an elegant source of heat matching any setting. What is more, vertically arranged panels create a modern visualisation, which match all interior design concepts.



- › **Horizontal pipes:** round Ø 30
- › **Vertical pipes:** rectangular 8 x 70 mm
- › **Detail work:** radiator made from low-carbon steel with powder coated finish
- › **Standard colours:** white RAL 9003 or anthracite RAL 7016
- › **Mounting:** mounting kit included
- › **Accessories:** side covers
- › **Further information:** non-standard size available to order



› **Types of connections:** page 184-185

› **Recommended valves kits** details on pages 178-179

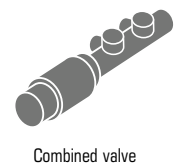
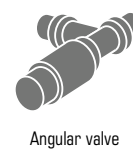
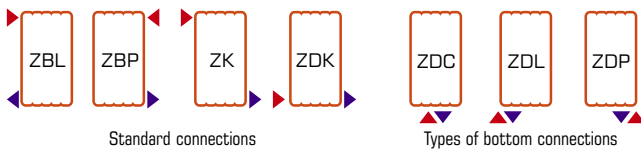

6+2
WARRANTY

2 additional years
of warranty
when purchasing
valves

info@luxrad.com

NIAGARA DOUBLE



Height [mm]	Width [mm]	Collector Spacing [mm]	Depth [mm]	Space between wall and power slots [mm]	Radiator Weight [kg]	Radiator capacity [dm ³]	Power level [W] 55/45/20	Power level [W] 75/65/20	Power level [W] 90/70/20
600	295	550	68	47	10	3	154	297	373
600	445	550	68	47	15.4	4.4	232	446	561
600	595	550	68	47	20.4	5.8	309	594	747
600	745	550	68	47	25.4	7.3	387	743	934
600	895	550	68	47	30.4	8.7	465	891	1120
600	1045	550	68	47	35.4	10.2	542	1040	1308
1000	295	950	68	47	16	5	242	475	597
1000	445	950	68	47	24.7	6.9	364	712	895
1000	595	950	68	47	32.9	9.3	485	950	1195
1000	745	950	68	47	29.3	8.4	607	1187	1493
1000	895	950	68	47	49.1	13.9	728	1424	1791
1000	1045	950	68	47	57.3	16.2	849	1662	2090
1500	295	1450	68	47	25	7	360	690	868
1500	445	1450	68	47	37.3	10.2	540	1035	1302
1500	595	1450	68	47	49.6	13.5	721	1381	1737
1500	745	1450	68	47	62	16.9	901	1726	2171
1500	895	1450	68	47	74.2	20.3	1082	2071	2605
1500	1045	1450	68	47	86.5	23.7	1262	2416	3039
1800	295	1750	68	47	29	8	423	817	1027
1800	445	1750	68	47	44.3	12.1	714	1377	1732
1800	595	1750	68	47	59	16.1	927	1789	2250
1800	745	1750	68	47	73.7	20.1	1059	2044	2571
1800	895	1750	68	47	88.3	24.2	1270	2453	3085
1800	1045	1750	68	47	103	28.2	1483	2862	3600
2000	295	1950	68	47	32	9	464	901	1133
2000	445	1950	68	47	49	13.4	779	1513	1903
2000	595	1950	68	47	65.2	17.8	1013	1965	2471
2000	745	1950	68	47	81.5	22.3	1162	2254	2835
2000	895	1950	68	47	97.7	26.8	1394	2706	3404
2000	1045	1950	68	47	114	31.2	1627	3156	3970

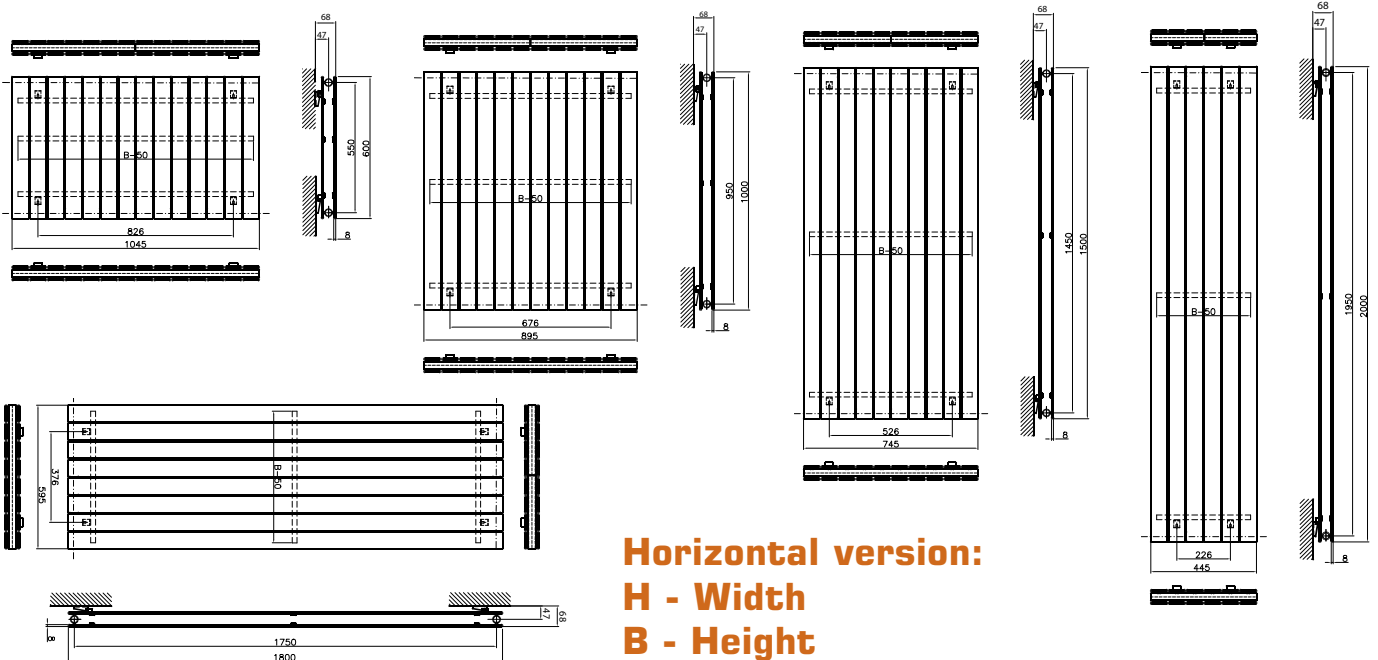

NIAGARA DOUBLE



Doubled Subtle charm

Thanks its flat, smooth design, NIAGARA double presents itself as an elegant source of heat matching any setting. Vertically or horizontal arranged panels create a modern visualisation, which match all interior design concepts.



- › **Horizontal pipes:** round Ø 30
- › **Vertical pipes:** rectangular 8 x 70 mm
- › **Detail work:** radiator made from low-carbon steel with powder coated finish
- › **Standard colours:** white RAL 9003 or anthracite RAL 7016
- › **Mounting:** mounting kit included
- › **Accessories:** side covers
- › **Further information:** non-standard size available to order
Panels mounted on both sides of the power collectors



› **Types of connections:** page 184-185

› **Recommended valves kits** details on pages 178-179

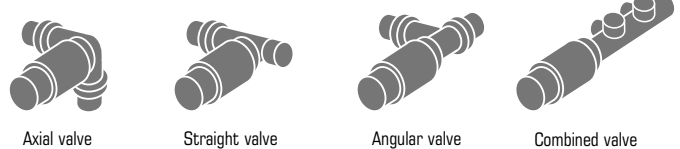
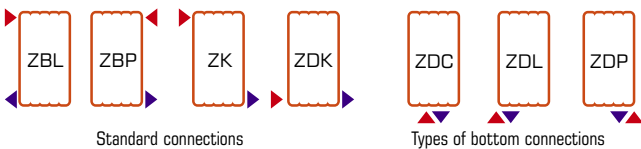

6+2
WARRANTY

2 additional years
of warranty
when purchasing
valves

info@luxrad.com

35

NIAGARA HORIZONTAL

WITH A THERMOSTAT



Technical specification for single version

Height [mm]	Width [mm]	Collector Spacing [mm]	Depth [mm]	Space between wall and power slots [mm]	Radiator Weight [kg]	Radiator capacity [dm ³]	Power level [W] 55/45/20	Power level [W] 75/65/20	Power level [W] 90/70/20
295	600	50	74	44	4.6	1.1	112	214	269
295	1000	50	74	44	7.2	1.7	177	342	430
295	1500	50	74	44	10.4	2.3	262	499	627
370	600	50	74	44	5.8	1.4	140	268	337
370	1000	50	74	44	9	2.1	222	428	538
370	1500	50	74	44	13	2.9	328	624	784
445	600	50	74	44	6.9	1.7	168	321	403
445	1000	50	74	44	10.8	2.5	267	513	645
445	1500	50	74	44	15.6	3.5	394	749	942
520	600	50	74	44	8	2	196	375	471
520	1000	50	74	44	12.5	2.3	311	599	753
520	1500	50	74	44	18.2	4.1	459	874	1099
595	600	50	74	44	9.2	2.3	224	427	537
595	1000	50	74	44	14.3	3.3	356	684	860
595	1500	50	74	44	20.8	4.7	525	999	1256

Technical specification for double version

Height [mm]	Width [mm]	Collector Spacing [mm]	Depth [mm]	Space between wall and power slots [mm]	Radiator Weight [kg]	Radiator capacity [dm ³]	Power level [W] 55/45/20	Power level [W] 75/65/20	Power level [W] 90/70/20
295	600	50	86	56	8.5	1.9	155	297	373
295	1000	50	86	56	13.7	3	242	475	597
295	1500	50	86	56	20.1	4.3	360	690	868
370	600	50	86	56	10.6	2.4	193	372	467
370	1000	50	86	56	17	3.7	303	593	745
370	1500	50	86	56	25.1	5.4	450	862	1084
445	600	50	86	56	12.7	2.9	232	446	561
445	1000	50	86	56	20.4	4.5	364	712	895
445	1500	50	86	56	30.1	6.5	540	1035	1302
520	600	50	86	56	14.8	3.4	270	520	654
520	1000	50	86	56	23.8	5.2	424	831	1045
520	1500	50	86	56	35.1	7.6	630	1208	1519
595	600	50	86	56	16.9	3.9	309	594	747
595	1000	50	86	56	27.2	6	485	950	1195
595	1500	50	86	56	40.1	8.6	721	1381	1737

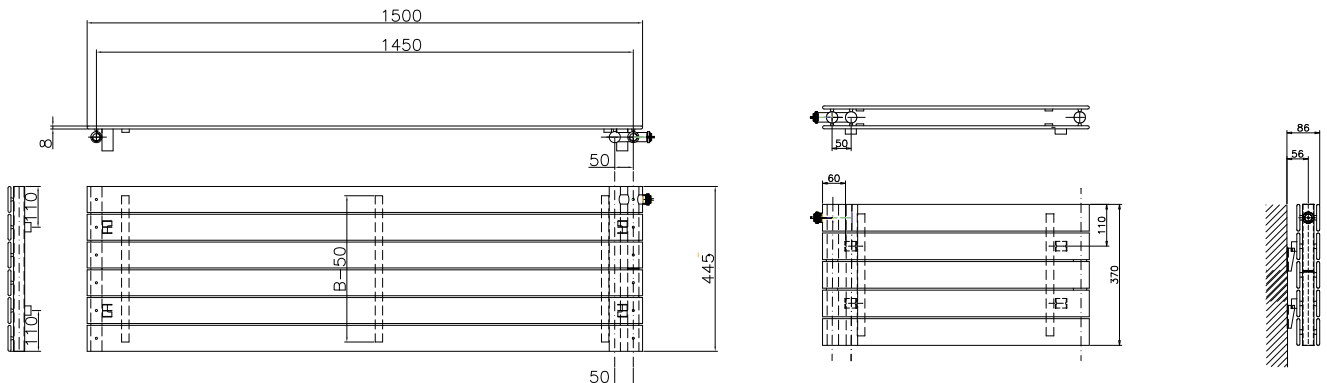

NIAGARA HORIZONTAL WITH A THERMOSTAT



Decorative, Energy-efficient

Designed as an alternative for flat radiators. The horizontal Niagara with a built in thermostat displays yet another concept in the arrangement of modern interiors.



Thermostatic head and insert included

- › **Horizontal pipes:** round Ø 30
- › **Vertical pipes:** rectangular 8 x 70 mm
- › **Thermostat:** mounting thread M 30 x 1,5
- › **Detail work:** radiator made from low-carbon steel with powder coated finish
- › **Standard colours:** white RAL 9003 or anthracite RAL 7016
- › **Mounting:** mounting kit included
- › **Accessories:** side covers
- › **Further information:** Thermostatic head included



› **Types of connections:** page 184-185

› **Recommended valves kits** details on pages 178-179



Standard connections



Combined valve



NIAGARA

STANDARD COLOUR WITH COVER



Height [mm]	Width [mm]	Collector Spacing [mm]	Depth [mm]	Space between wall and power slots [mm]	Radiator Weight [kg]	Radiator capacity [dm ³]	Power level [W] 55/45/20	Power level [W] 75/65/20	Power level [W] 90/70/20
1000	300	950	76	52	9	2.4	162	314	395
1000	450	950	76	52	13.5	3.6	245	472	593
1000	600	950	76	52	17.9	4.7	328	629	791
1500	300	1450	76	52	13.5	3.5	242	460	578
1500	450	1450	76	52	20.2	5.3	363	690	868
1500	600	1450	76	52	26.8	7	484	919	1156
1800	300	1750	76	52	16.2	4.2	285	546	686
1800	450	1750	76	52	24.3	6.3	428	820	1031
1800	600	1750	76	52	32.3	8.4	551	1052	1323

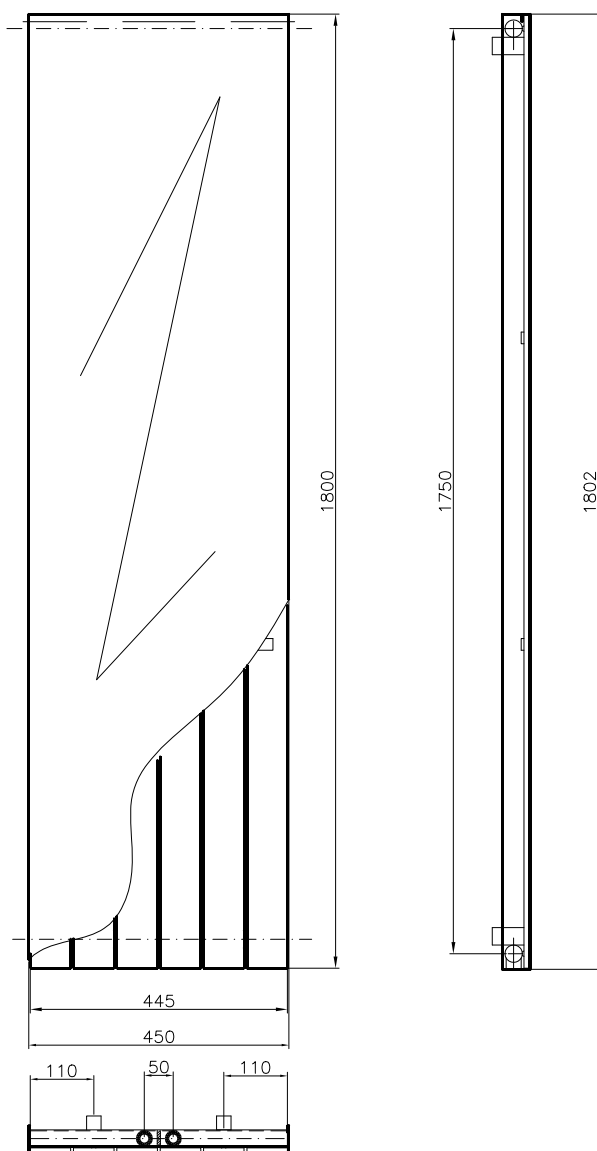

Horizontal version:
H - Width
B - Height

NIAGARA

STANDARD COLOUR WITH COVER



Functional and discreet

This is how Niagara presents itself when covered with its smooth, exceptionally easy to clean & maintain surface. It is a very discreet element of interior design, as well as a modern source of heat. Design and functionality in one.



- › **Horizontal pipes:** round Ø 30
- › **Vertical pipes:** rectangular 8 x 70 mm
- › **Cover:** 1,5 mm laser-curved, pasted steel
- › **Detail work:** radiator made from low-carbon steel with powder coated finish cover - low-carbon steel with powder coated finish
- › **Standard colours:** white RAL 9003 or anthracite RAL 7016
- › **Mounting:** mounting kit included
- › **Further information:** non-standard size available to order



› **Types of connections:** page 184-185

› **Recommended valves kits** details on pages 178-179

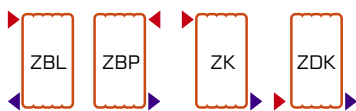

Standard connections



Types of bottom connections



Axial valve



Straight valve



Angular valve



Combined valve

6+2
WARRANTY

2 additional years
of warranty
when purchasing
valves

info@luxrad.com

39

NIAGARA

WITH STAINLESS STEEL COVER



Height [mm]	Width [mm]	Collector Spacing [mm]	Depth [mm]	Space between wall and power slots [mm]	Radiator Weight [kg]	Radiator capacity [dm ³]	Power level [W] 55/45/20	Power level [W] 75/65/20	Power level [W] 90/70/20
1000	300	950	76	52	9	2.4	162	314	395
1000	450	950	76	52	13.5	3.6	245	472	593
1000	600	950	76	52	17.9	4.7	328	629	791
1500	300	1450	76	52	13.5	3.5	242	460	578
1500	450	1450	76	52	20.2	5.3	363	690	868
1500	600	1450	76	52	26.8	7	484	919	1156
1800	300	1750	76	52	16.2	4.2	285	546	686
1800	450	1750	76	52	24.3	6.3	428	820	1031
1800	600	1750	76	52	32.3	8.4	551	1052	1323

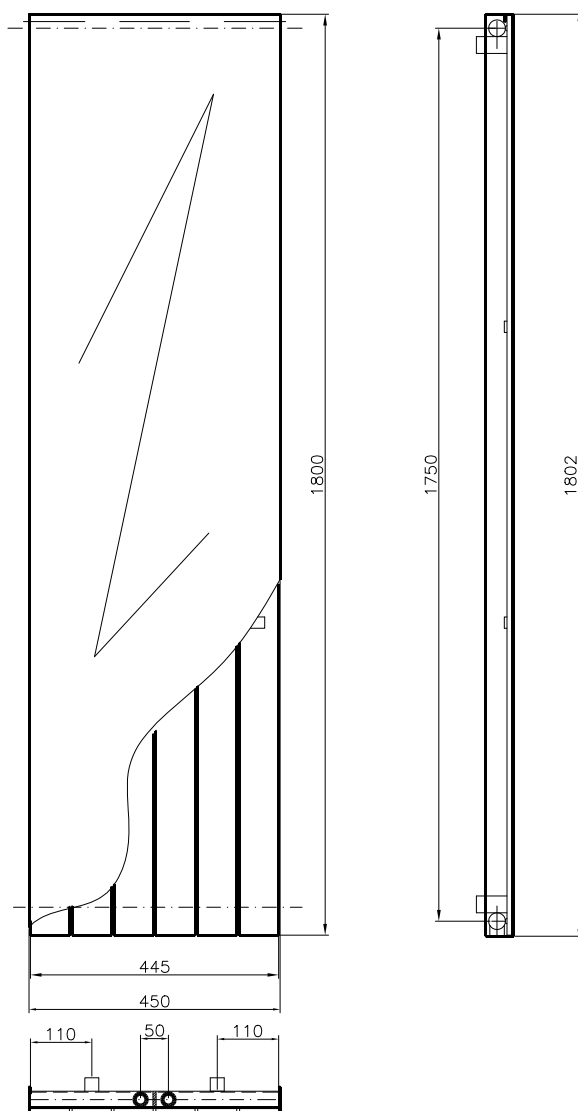

Horizontal version:
H - Width
B - Height

NIAGARA

WITH STAINLESS STEEL COVER



Noble look

This is how Niagara presents itself with stainless steel cover. It is a very discreet element of interior design, as well as a modern source of heat. Design and functionality in one.



- **Horizontal pipes:** round Ø 30
- **Vertical pipes:** rectangular 8 x 70 mm
- **Cover:** 1,5 mm laser-curved, pasted steel
- **Detail work:** radiator made from low-carbon steel with powder coated finish, cover - stainless steel
- **Mounting:** mounting kit included
- **Further information:** non-standard size available to order



Electric version available



Hydro-electric version available



Horizontal version available



Additional hangers

➤ **Types of connections:** page 184-185

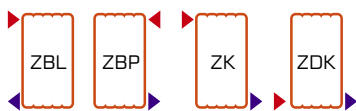

Standard connections



Types of bottom connections

➤ **Recommended valves kits** details on pages 178-179



Axial valve



Straight valve



Angular valve



Combined valve

6+2
WARRANTY

2 additional years of warranty when purchasing valves

info@luxrad.com

41

NIAGARA

WITH TEMPERED GLASS COVER



Height [mm]	Width [mm]	Collector Spacing [mm]	Depth [mm]	Space between wall and power slots [mm]	Radiator Weight [kg]	Radiator capacity [dm ³]	Power level [W] 55/45/20	Power level [W] 75/65/20	Power level [W] 90/70/20
1000	295	950	96	52	15.9	2.4	162	314	395
1000	370	950	96	52	19.9	3	204	394	495
1000	445	950	96	52	24	3.7	245	472	593
1000	520	950	96	52	27	4.3	287	550	691
1000	595	950	96	52	32	5	328	629	791
1500	295	1450	96	52	23.2	3.5	242	460	578
1500	370	1450	96	52	28.9	4.4	303	575	723
1500	445	1450	96	52	34.7	5.3	363	690	868
1500	520	1450	96	52	40.5	6.2	424	804	1011
1500	595	1450	96	52	48.9	7	484	919	1156
1800	295	1750	96	52	27.5	4	285	546	686
1800	370	1750	96	52	34.5	5	357	683	859
1800	445	1750	96	52	41.6	6.3	428	820	1031
1800	520	1750	96	52	48.6	7.4	482	921	1158
1800	595	1750	96	52	58.7	8.4	551	1052	1323
1800	670	1750	96	52	66	9.5	620	1184	1489

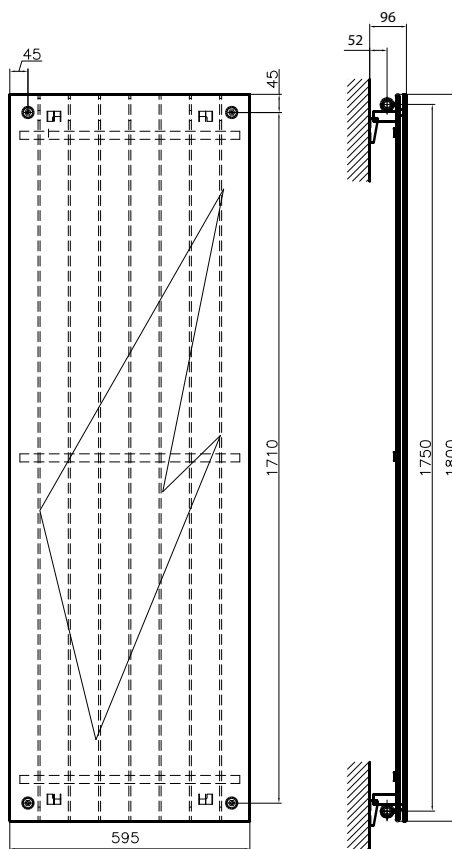

Horizontal version:
H - Width
B - Height

NIAGARA

WITH TEMPERED GLASS COVER



Warm hidden in glass

A modern, beautiful source of heat. The glass element, which can be coloured or a mirror, perfectly match any interior. Bathroom, entry hall, dressing room - the possibilities are endless.



- › **Horizontal pipes:** round Ø 30
- › **Vertical pipes:** rectangular 8 x 70 mm
- › **Cover:** tempered glass pasted to the radiator
- › **Detail work:** radiator made from low-carbon steel with powder coated finish, cover- tempered glass 8 mm
- › **Standard colours:** white, grey, black, red
- › **Mounting:** mounting kit included
- › **Further information:** non-standard size available to order



Horizontal version available



6 YEARS Warranty



95°C Maximum temperature

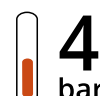

4 bar Maximum work pressure



Electric version available



Hydro-electric version available



KOLOR RAL colour system and special colours available



Additional hangers

› **Types of connections:** page 184-185

› **Recommended valves kits** details on pages 178-179

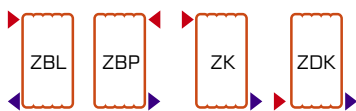

Standard connections



Types of bottom connections



Axial valve



Straight valve



Angular valve



Combined valve

6+2
WARRANTY

2 additional years of warranty when purchasing valves

info@luxrad.com

43

NIAGARA WITH MIRROR COVER



Height [mm]	Width [mm]	Collector Spacing [mm]	Depth [mm]	Space between wall and power slots [mm]	Radiator Weight [kg]	Radiator capacity [dm ³]	Power level [W] 55/45/20	Power level [W] 75/65/20	Power level [W] 90/70/20
1000	295	950	96	52	15.9	2.4	162	314	395
1000	370	950	96	52	19.9	3	204	394	495
1000	445	950	96	52	24	3.7	245	472	593
1000	520	950	96	52	27	4.3	287	550	691
1000	595	950	96	52	32	5	328	629	791
1500	295	1450	96	52	23.2	3.5	242	460	578
1500	370	1450	96	52	28.9	4.4	303	575	723
1500	445	1450	96	52	34.7	5.3	363	690	868
1500	520	1450	96	52	40.5	6.2	424	804	1011
1500	595	1450	96	52	48.9	7	484	919	1156
1800	295	1750	96	52	27.5	4	285	546	686
1800	370	1750	96	52	34.5	5	357	683	859
1800	445	1750	96	52	41.6	6.3	428	820	1031
1800	520	1750	96	52	48.6	7.4	482	921	1158
1800	595	1750	96	52	58.7	8.4	551	1052	1323
1800	670	1750	96	52	66	9.5	620	1184	1489

Horizontal version:
H - Width
B - Height

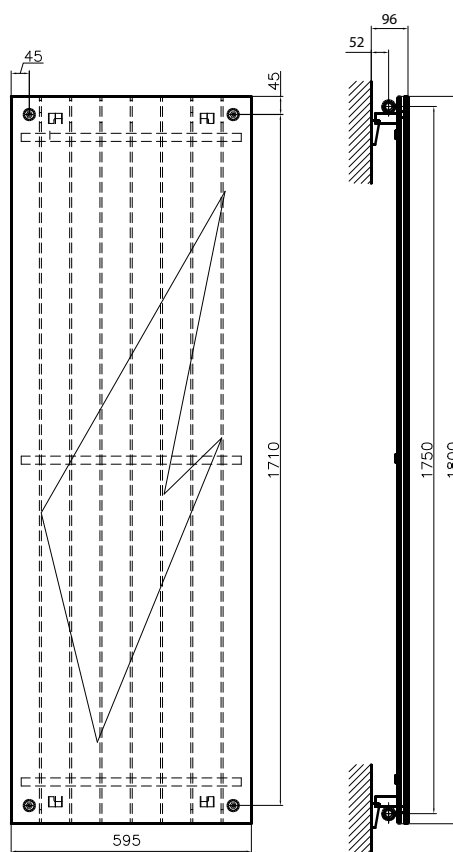

NIAGARA WITH MIRROR COVER



Warm hidden in glass

A modern, beautiful source of heat. The glass element, which can be coloured or a mirror, perfectly match any interior. Bathroom, entry hall, dressing room - the possibilities are endless.



- › **Horizontal pipes:** round Ø 30
- › **Vertical pipes:** rectangular 8 x 70 mm
- › **Cover:** tempered glass pasted to the radiator
- › **Detail work:** radiator made from low-carbon steel with powder coated finish, cover-tempered mirror 6 mm
- › **Standard colours:** white, grey, black, red, mirror
- › **Mounting:** mounting kit included
- › **Further information:** non-standard size available to order



› **Types of connections:** page 184-185

› **Recommended valves kits** details on pages 178-179

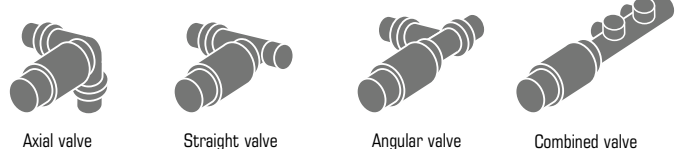
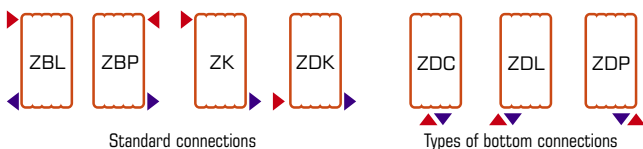

6+2
WARRANTY

2 additional years
of warranty
when purchasing
valves

info@luxrad.com

45

NIAGARA

GLASS COVER WITH GRAPHIC



Height [mm]	Width [mm]	Collector Spacing [mm]	Depth [mm]	Space between wall and power slots [mm]	Radiator Weight [kg]	Radiator capacity [dm ³]	Power level [W] 55/45/20	Power level [W] 75/65/20	Power level [W] 90/70/20
1000	295	950	96	52	15.9	2.4	162	314	395
1000	370	950	96	52	19.9	3	204	394	495
1000	445	950	96	52	24	3.7	245	472	593
1000	520	950	96	52	27	4.3	287	550	691
1000	595	950	96	52	32	5	328	629	791
1500	295	1450	96	52	23.2	3.5	242	460	578
1500	370	1450	96	52	28.9	4.4	303	575	723
1500	445	1450	96	52	34.7	5.3	363	690	868
1500	520	1450	96	52	40.5	6.2	424	804	1011
1500	595	1450	96	52	48.9	7	484	919	1156
1800	295	1750	96	52	27.5	4	285	546	686
1800	370	1750	96	52	34.5	5	357	683	859
1800	445	1750	96	52	41.6	6.3	428	820	1031
1800	520	1750	96	52	48.6	7.4	482	921	1158
1800	595	1750	96	52	58.7	8.4	551	1052	1323
1800	670	1750	96	52	66	9.5	620	1184	1489

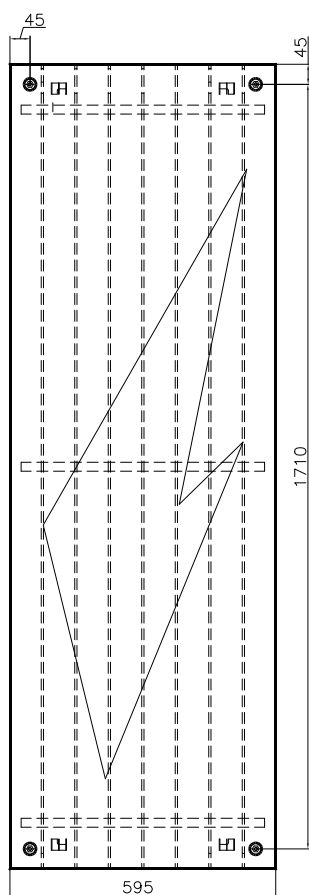

Our glass covers are made with 8-millimetre-thick tempered OptiWhite glass which, due to a lower iron content, is practically a colourless float glass. The green tint of normal glass, especially visible when decorated with light colours, has been completely eliminated.

OptiWhite glass preserves natural colours, makes objects appear sharper and transmits more light.

UV coating is used during the printing and painting process making the finished product resistant to sun rays.

Using UV-hardened varnishes allows us to achieve a very durable and elegant finish.

Horizontal version:
H - Width, B - Height

NIAGARA

GLASS COVER WITH GRAPHIC



Only my

This is our latest concept how make our products tailored to our customers preferences. This model is constructed from flat panels with rounded edges, to which we apply a precision attached toughened glass graphic or photo. We provide a selection of graphic designs, but also cater for the clients taste and desires and can implement an individuals chosen design. This innovational approach to our products allows for individuality, just as you please.

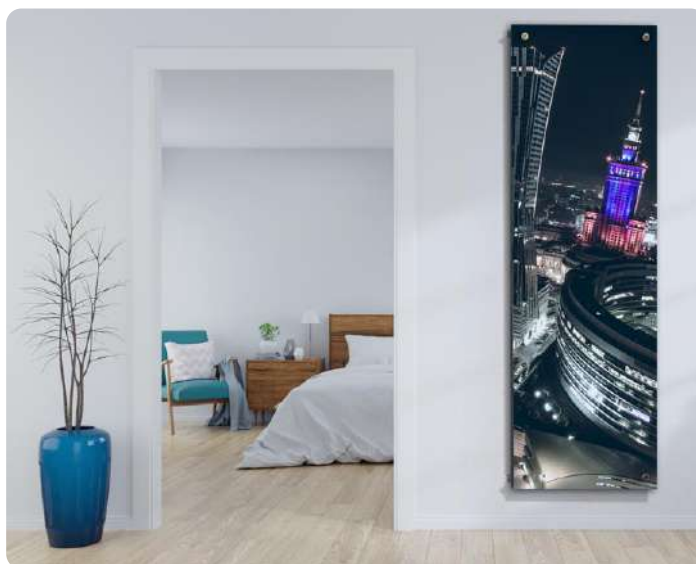

- › **Horizontal pipes:** round Ø 30
- › **Vertical pipes:** rectangular 8 x 70 mm
- › **Cover:** tempered glass pasted to the radiator
- › **Detail work:** radiator made from low-carbon steel with powder coated finish, cover-tempered glass 8 mm with graphics
- › **Available graphics:** recommended standard graphics (page 48)
- › **Mounting:** mounting kit included
- › **Further information:** non-standard size available to order



› **Types of connections:** page 184-185

› **Recommended valves kits** details on pages 178-179

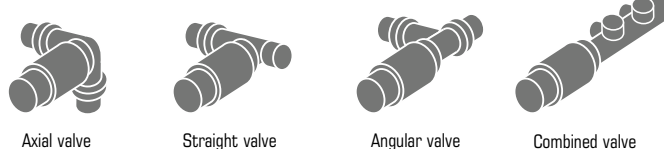
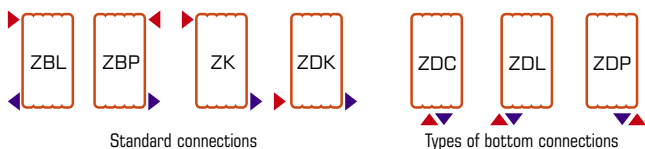

6+2
WARRANTY

2 additional years
of warranty
when purchasing
valves

info@luxrad.com

NIAGARA

GLASS COVER WITH GRAPHIC



Possibility of making glass cover according to own individual graphic project.



F01



F02



F03



F04



F05



F06



F07



F08



F09



F10



F11



F12



F13



F14



F15

Cooperating with Michał Sadowski, we support the Hospice for children in Wrocław. We present the collection of ten photographs of his authorship, which can be printed on our radiators.



F16



F17



F18

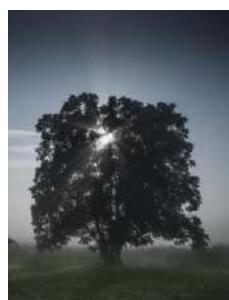

F19



F20



F21



F22



F23



F24



F25

NIAGARA

GLASS COVER WITH GRAPHIC



6+2
WARRANTY

2 additional years
of warranty
when purchasing
valves

info@luxrad.com

NIAGARA LED



Height [mm]	Width [mm]	Collector Spacing [mm]	Depth [mm]	Space between wall and power slots [mm]	Radiator Weight [kg]	Radiator capacity [dm ³]	Power level [W] 55/45/20	Power level [W] 75/65/20	Power level [W] 90/70/20
1500	445	1450	97	44	34.7	5.3	363	690	868
1500	520	1450	97	44	40.5	6.2	424	804	1011
1500	595	1450	97	44	48.9	7	484	919	1156
1800	445	1750	97	44	41.6	6.3	428	820	1031
1800	520	1750	97	44	48.6	7.4	482	921	1158
1800	595	1750	97	44	58.7	8.4	551	1052	1323

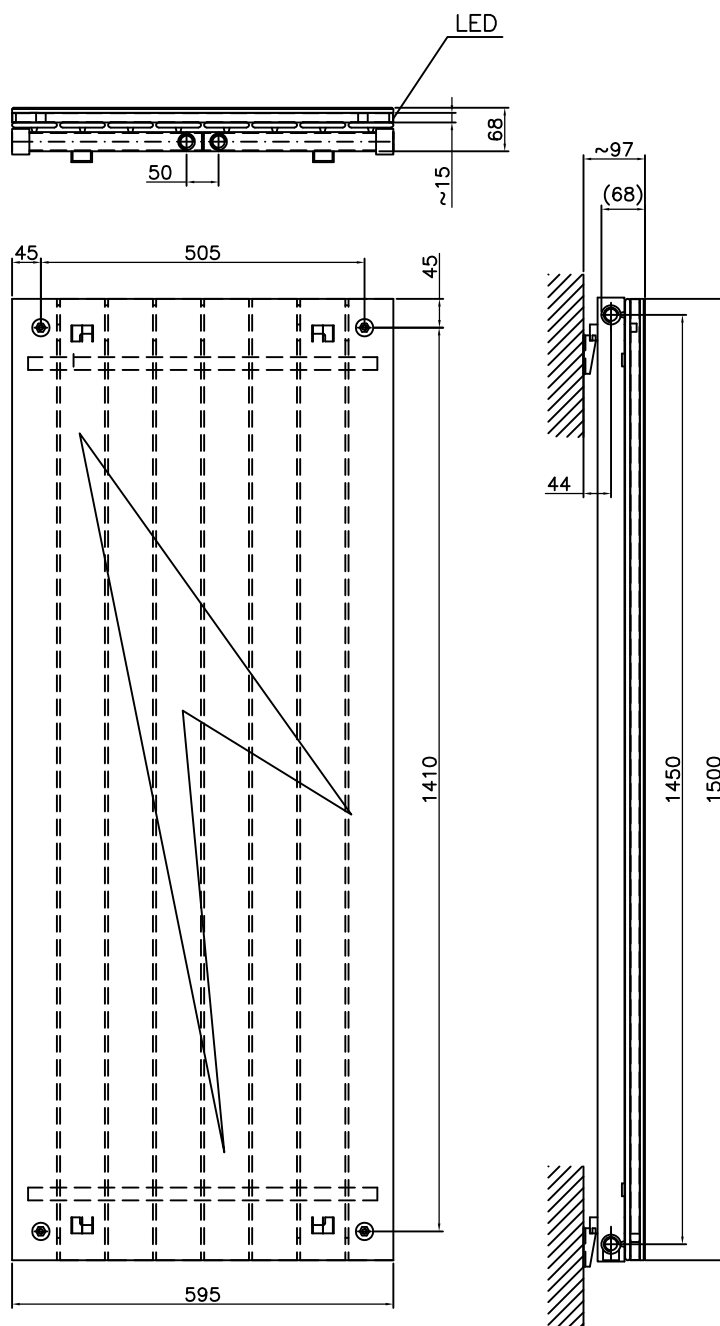

NIAGARA LED



Decorative radiator with lighting

NIAGARA LED is a steel decorative radiator with LED lighting. You may choose from many graphic patterns or create your own. Brightness and colour are controlled by a remote control. The light can also be turned off. NIAGARA LED can become a significant element of Your interior.



- › **Horizontal pipes:** round Ø 30
- › **Vertical pipes:** rectangular 8 x 70 mm
- › **Cover:** tempered glass pasted to the radiator
- › **Detail work:** radiator made from low-carbon steel with powder coated finish, cover- tempered glass with graphics
- › **Available graphics:** recommended standard graphics (page 48)
- › **Mounting:** mounting kit included
- › **Further information:** non-standard size available to order



Horizontal version available



Warranty



Maximum temperature



Maximum work pressure



Electric version available



Hydro-electric version available

› **Types of connections:** page 184-185

› **Recommended valves kits** details on pages 178-179

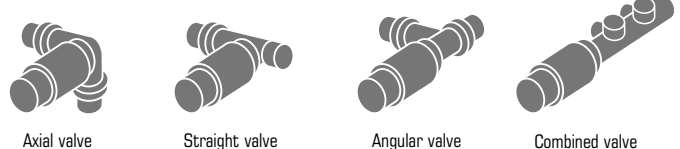
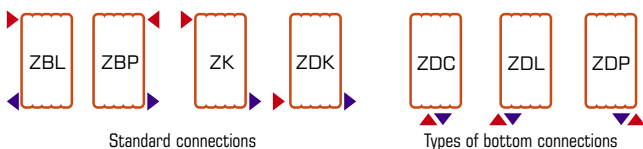

6+2
WARRANTY

2 additional years of warranty when purchasing valves

info@luxrad.com

51

NIAGARA WITH A MIRROR



Height [mm]	Width [mm]	Collector Spacing [mm]	Depth [mm]	Space between wall and power slots [mm]	Radiator Weight [kg]	Radiator capacity [dm ³]	Power level [W] 55/45/20	Power level [W] 75/65/20	Power level [W] 90/70/20
1800	445	1750	74	52	17.3	3.4	285	546	686
1800	595	1750	74	52	25.3	5.5	428	820	1031
1800	670	1750	74	52	29.2	6.6	482	921	1158

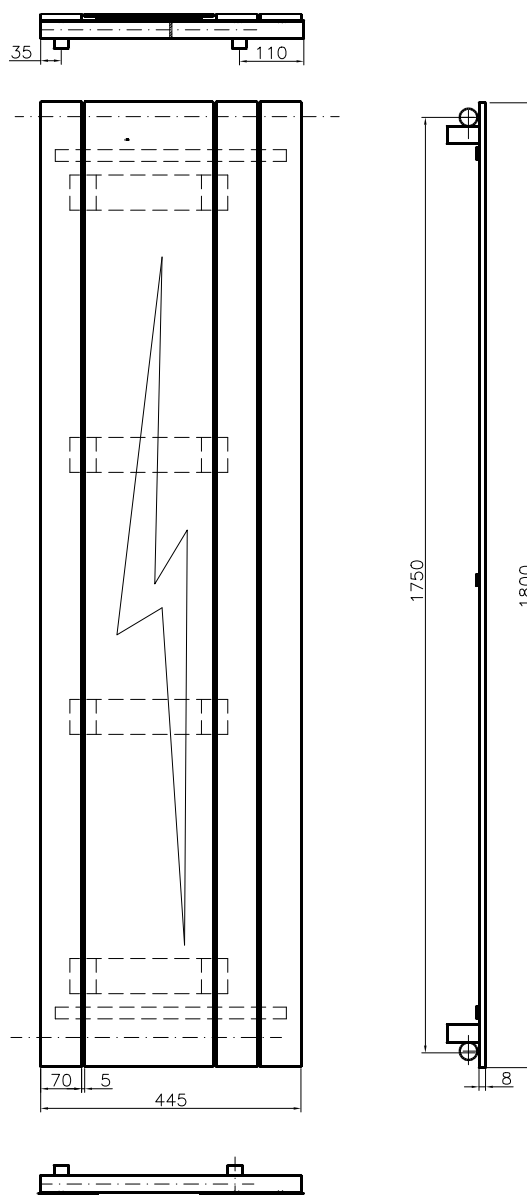

NIAGARA WITH A MIRROR



Mirror, mirror on the wall...

Practical and beautiful. Incorporating a mirror gives a double effect - the ability to see oneself and the visual effect it provides. To see and to be seen. Niagara with a mirror attracts attention and, what is more it looks stunning.



- › **Horizontal pipes:** round Ø 30
- › **Vertical pipes:** rectangular 8 x 70 mm
- › **Mirror:** width of 220 mm
- › **Detail work:** radiator made from low-carbon steel with powder coated finish, cover - tempered mirror 6 mm
- › **Standard colours:** white RAL 9003 or anthracite RAL 7016
- › **Mounting:** mounting kit included
- › **Further information:** non-standard size available to order



› **Types of connections:** page 184-185

› **Recommended valves kits** details on pages 178-179

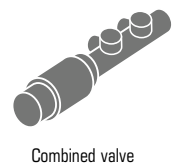
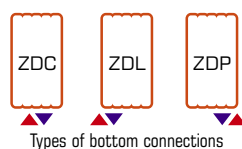
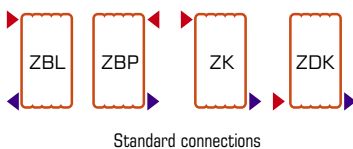

6+2
WARRANTY

2 additional years
of warranty
when purchasing
valves

info@luxrad.com

53

SLIM LINE



Height [mm]	Width [mm]	Collector Spacing [mm]	Depth [mm]	Space between wall and power slots [mm]	Radiator Weight [kg]	Radiator capacity [dm ³]	Power level [W] 55/45/20	Power level [W] 75/65/20	Power level [W] 90/70/20
1000	295	950	68	47	16	5	242	475	597
1000	445	950	68	47	24.7	6.9	364	712	895
1000	595	950	68	47	32.9	9.3	485	950	1195
1200	295	1150	68	47	16	5	290	570	716
1200	445	1150	68	47	24.7	6.9	436	854	1074
1200	595	1150	68	47	32.9	9.3	582	1140	1434
1400	295	1350	68	47	25	7	336	644	810
1400	445	1350	68	47	37.3	10.2	504	966	1215
1400	595	1350	68	47	49.6	13.5	673	1288	1621
1800	295	1750	68	47	24	8	476	918	1154
1800	445	1750	68	47	34	12.1	714	1377	1732
1800	595	1750	68	47	45	16.1	927	1789	2250

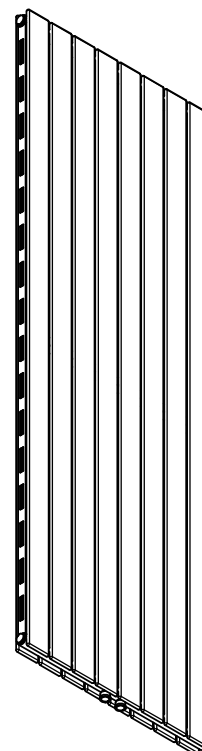
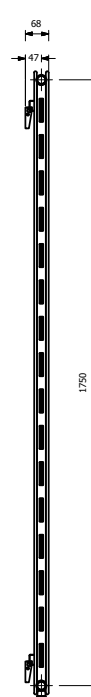
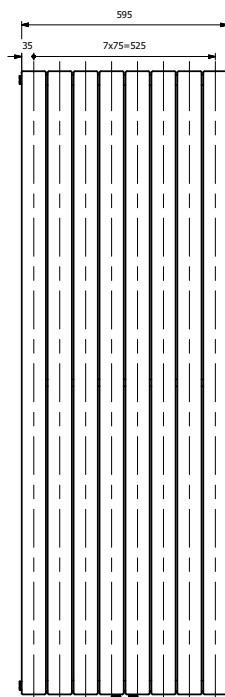
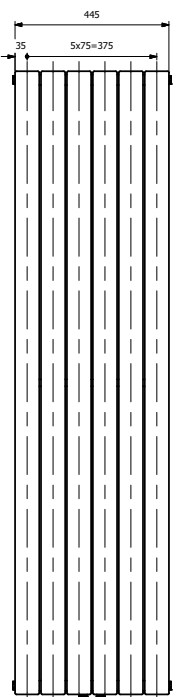
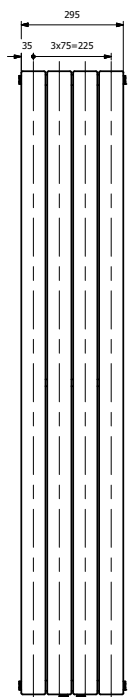

SLIM LINE



Slim design and exceptional power

The slim shape and uniform design of the Slim Line radiator makes it look exceptionally discreet and modern. It simply captivates with its elegance. The practical magnetic system of fastening for the side covers makes it extremely easy to keep the radiator clean. Its additional advantage is its minimal depth, which means that it takes up very little space in the living area. Slim Line is an excellent source of heat, that will work in any interior.

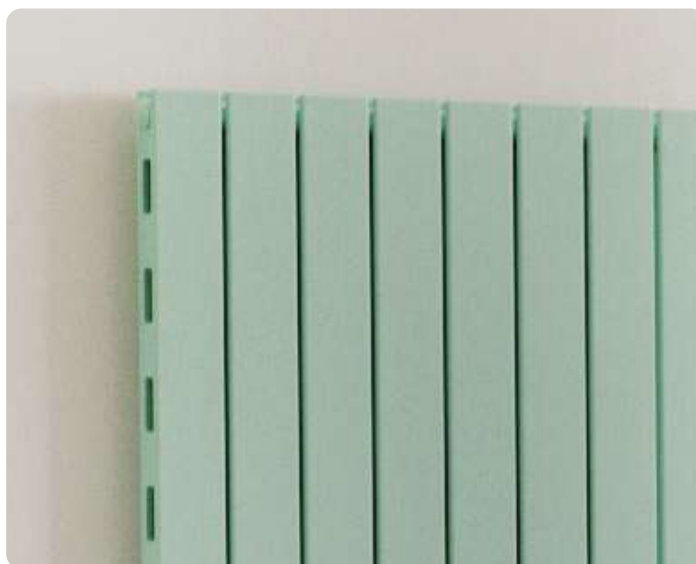
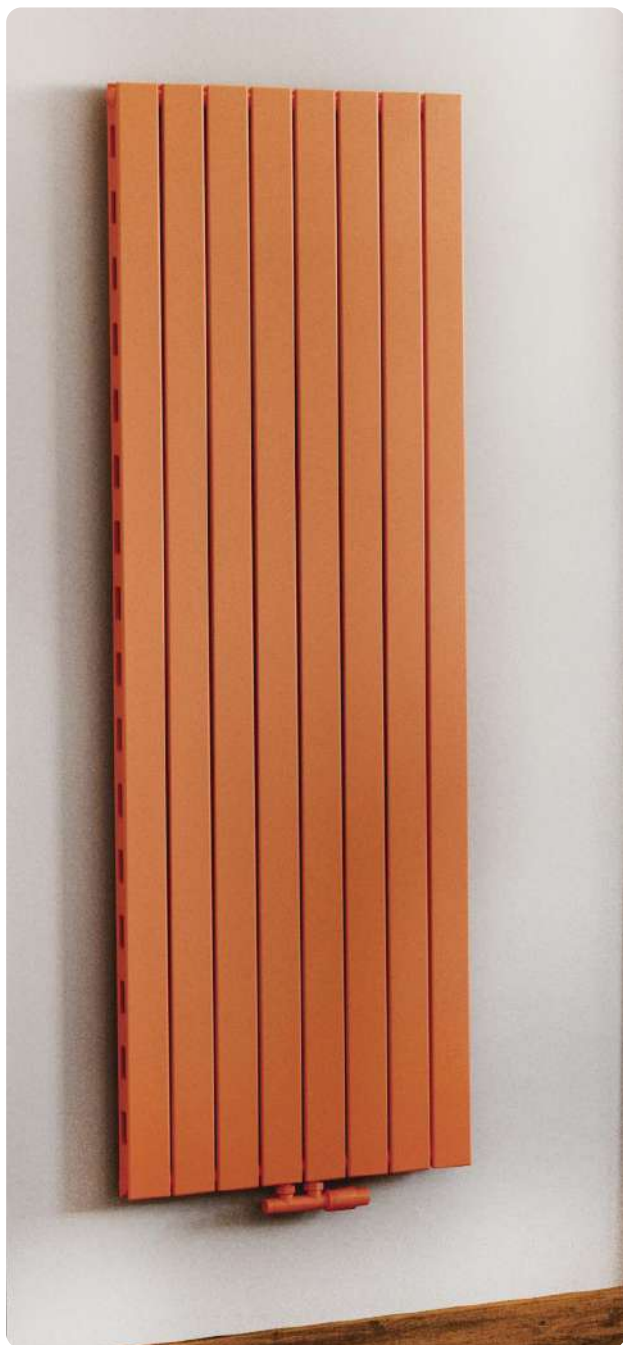

- › **Horizontal pipes:** round \varnothing 30
- › **Vertical panels:** rectangular 8 x 70 mm
- › **Construction:** Low-carbon powder-coated steel
- › **Standard colours:** RAL 9003 white or RAL 7016 anthracite
- › **Mounting brackets:** included with the heater
- › **Side covers:** side covers are included with the heater
- › **Other information:** panels mounted on both sides of the supply collectors, possibility to produce non-standard dimensions



Additional
hangers



RAL colour system and
special colours available



Warranty



Maximum
temperature



Maximum
work pressure

› **Types of connections:** page 184-185

› **Rekomendowane zastawy zaworów** details on pages 178-179

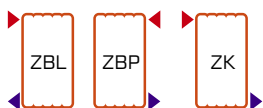

Standard connections w poziomych kolektorach



Types of bottom connections



Axial valve



Straight valve



Angular valve

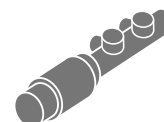

Combined valve

6+2
WARRANTY

2 additional years
of warranty
when purchasing
valves

info@luxrad.com

55

Height [mm]	Width [mm]	Collector Spacing [mm]	Depth [mm]	Space between wall and power slots [mm]	Radiator Weight [kg]	Radiator capacity [dm ³]	Power level [W] 55/45/20	Power level [W] 75/65/20	Power level [W] 90/70/20
1500	400	50	88-98	66-76	21	4.96	317	598	752
1500	500	50	88-98	66-76	26.4	6.2	396	747	939
1500	600	50	88-98	66-76	31.7	7.5	475	896	1127
1800	400	50	88-98	66-76	25.2	5.9	380	717	901
1800	500	50	88-98	66-76	31.7	7.45	474	895	1125
1800	600	50	88-98	66-76	38.04	9	570	1075	1352

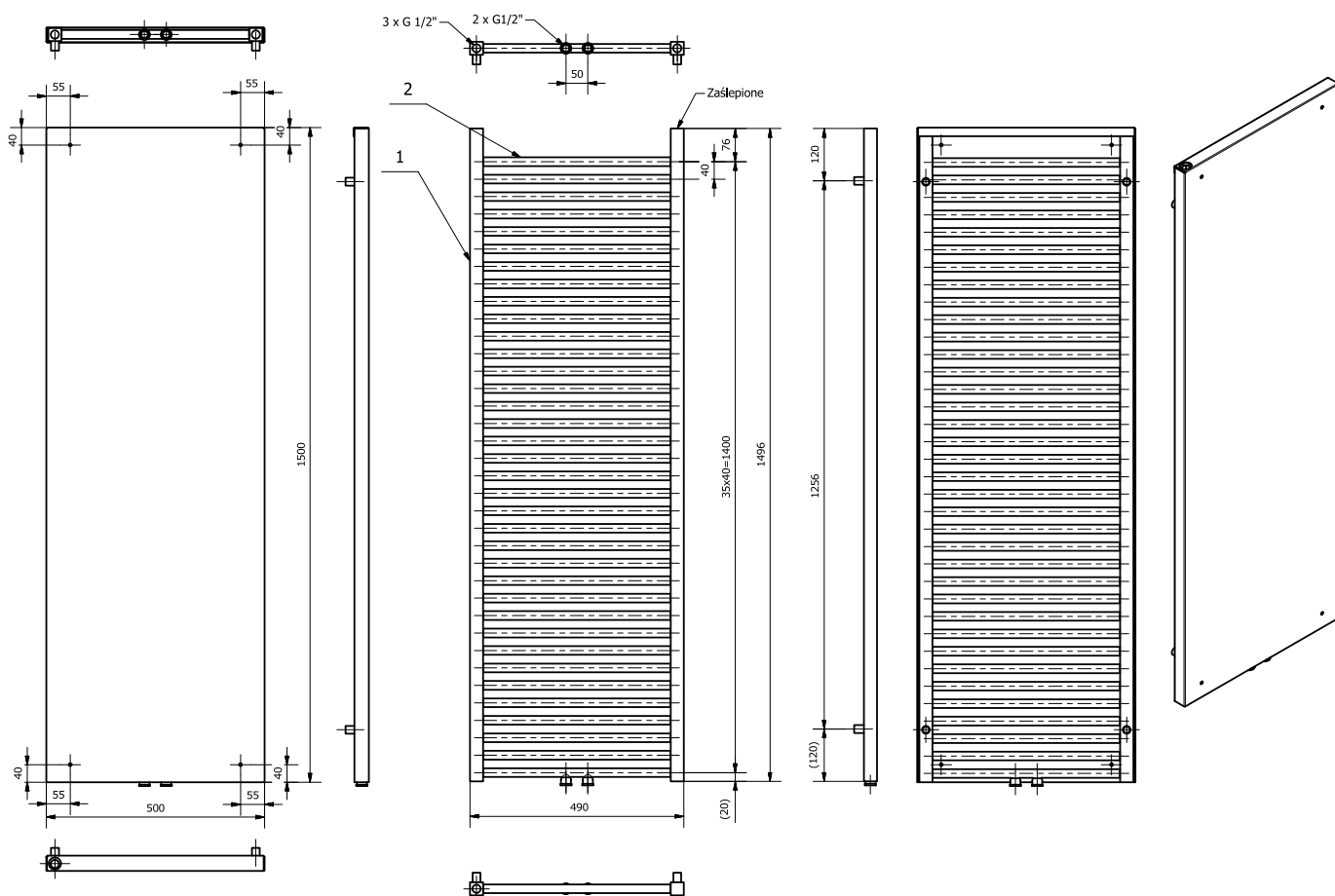

Heat behind the glass

Vitro, this glass radiator, was created for places, where innovative and sophisticated solutions are taken into account. It can be used practically in every interior – bathrooms, office rooms, hotels and spa. Glass option additionally make the impression of a bigger room.



- › **Vertical pipes:** square 30 / 30 mm
 - › **Horizontal pipes:** Ø 20
 - › **Cover:** steel cover with a mirror or glass attached
 - › **Detail work:** radiator made from low-carbon steel with powder coated finish, glass 4mm
 - › **Standard colours:** black, white, red, mirror
 - › **Mounting:** mounting kit included
- Further information:** non-standard size available to order



› **Types of connections:** page 184-185

› **Recommended valves kits** details on pages 178-179



Standard



Axial valve



Straight valve



Angular valve

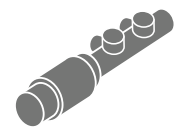

Combined valve

6+2
WARRANTY

2 additional years of warranty when purchasing valves

info@luxrad.com

57

V-LINE



Height [mm]	Width [mm]	Collector Spacing [mm]	Depth [mm]	Space between wall and power slots [mm]	Radiator Weight [kg]	Radiator capacity [dm ³]	Power level [W] 55/45/20	Power level [W] 75/65/20	Power level [W] 90/70/20
1500	400	50	82-92	66-76	18	4.96	336	634	797
1500	500	50	82-92	66-76	23.4	6.2	419	792	996
1500	600	50	82-92	66-76	28.7	7.5	503	950	1195
1800	400	50	82-92	66-76	22.2	5.9	403	760	956
1800	500	50	82-92	66-76	28.7	7.45	503	949	1193
1800	600	50	82-92	66-76	35.08	9	604	1139	1432

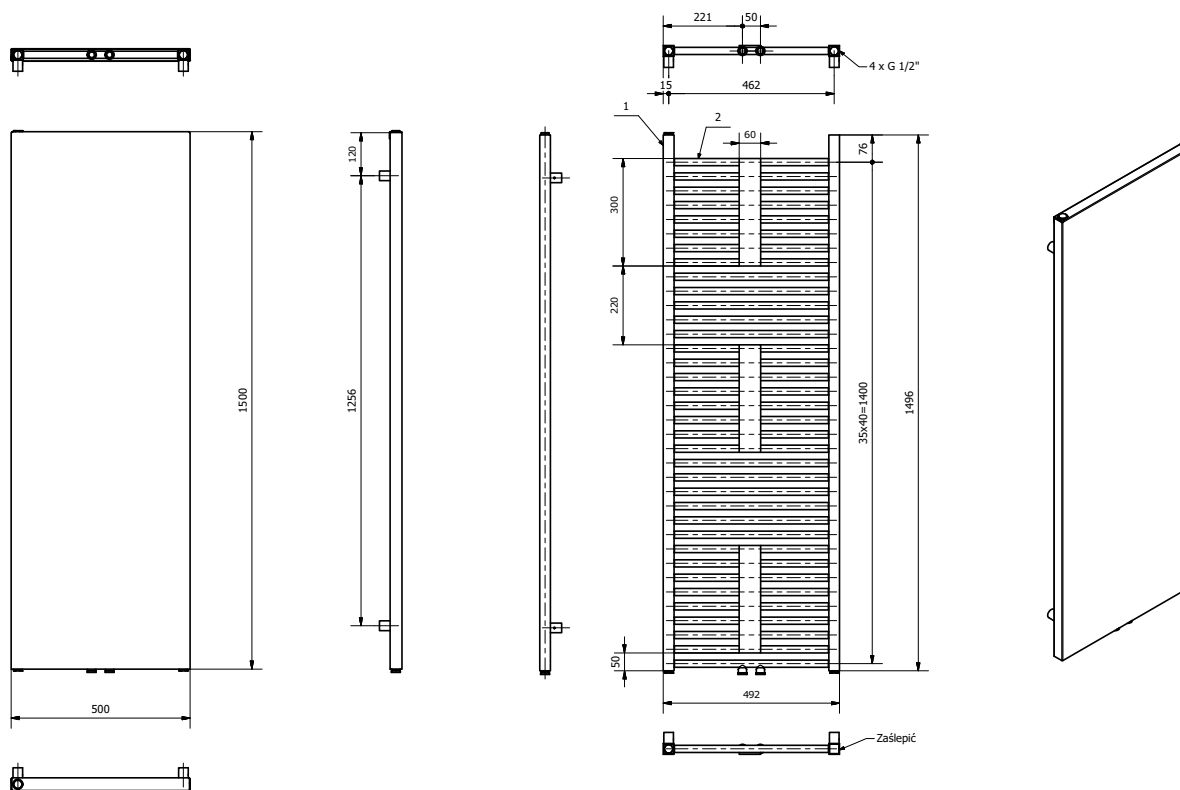

Straight line

Our new V-Line radiator from the Vitro family is characterised above all by its simple line, which makes this model ideal for modern spaces. Thanks to its simple form and shield, it can be an ideal background for interior arrangement, and if we care about a strong color accession - this model will also do. Just select the color from the RAL palette or special color palettes. Radiator is a choice for years, it is worth betting on timeless, uncomplicated design, which is a consistent element of the entire interior:



- > **Vertical pipes:** square 30 x 30 mm
- > **Horizontal pipes:** Ø 20
- > **Cover:** 1.5 mm sheet metal, laser bent and glued to the radiator
- > **Detail work:** radiator made from low-carbon steel with powder coated finish, cover - low carbon steel with powder coated
- > **Standard colours:** RAL 9003 white or RAL 7016 anthracite
- > **Mounting brackets:** included with the heater
- > **Other information:** possibility to produce non-standard dimensions



> **Types of connections:** page 184-185



Standard

> **Recommended valves kits** details on pages 178-179



Axial valve



Straight valve



Angular valve

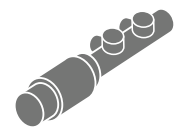

Combined valve

6+2
WARRANTY

2 additional years
of warranty
when purchasing
valves

info@luxrad.com

59

Height [mm]	Width [mm]	Collector Spacing [mm]	Depth [mm]	Space between wall and power slots [mm]	Radiator Weight [kg]	Radiator capacity [dm ³]	Power level [W] 55/45/20	Power level [W] 75/65/20	Power level [W] 90/70/20
600	300	550	145	61	13.7	3.5	209	401	504
600	390	550	145	61	17.8	4.6	272	522	656
600	440	550	145	61	20.6	5.3	314	602	757
600	500	550	145	61	23.5	6	351	674	847
600	590	550	145	61	27.6	7.1	408	782	983
1000	300	950	145	61	21.9	5.6	311	610	767
1000	390	950	145	61	28.5	7.3	405	793	997
1000	440	950	145	61	32.9	8.5	467	915	1151
1000	500	950	145	61	37.4	9.7	523	1025	1289
1000	590	950	145	61	44	11.4	607	1189	1495
1500	300	1450	145	61	32.2	8.4	444	851	1070
1500	390	1450	145	61	41.8	10.9	577	1106	1391
1500	440	1450	145	61	48.2	12.6	666	1276	1605
1500	500	1450	145	61	54.8	14.2	747	1431	1800
1500	590	1450	145	61	64.5	16.8	866	1658	2085
1800	300	1750	145	61	38.3	10	511	987	1241
1800	390	1750	145	61	49.7	13	665	1284	1615
1800	440	1750	145	61	57.4	15	768	1482	1864
1800	500	1750	145	61	65.2	17	860	1660	2088
1800	590	1750	145	61	76.7	20	997	1925	2421

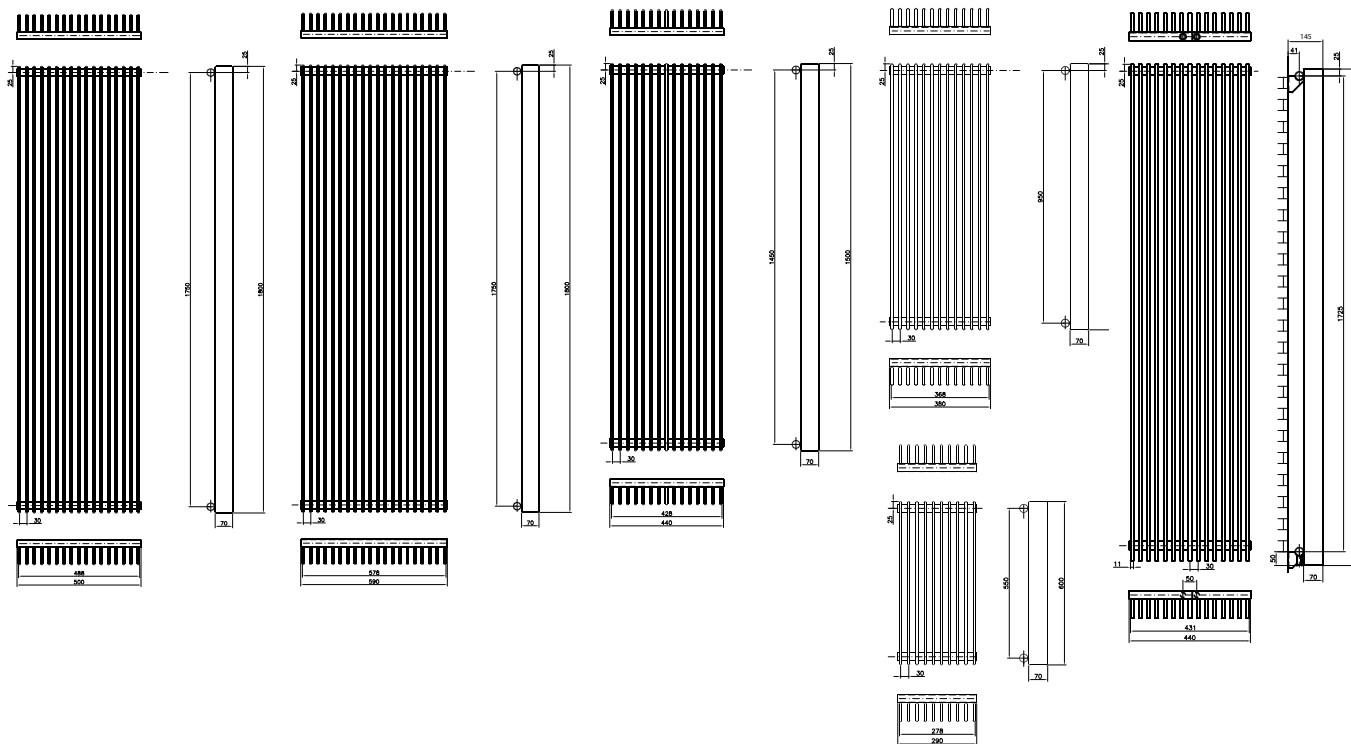

Appearance and performance

These elements characterise this product. In a corridor, dressing room or a living area - its appearance always attracts attention and pleases the eye. A large selection of advanced solutions.



- › **Horizontal pipes:** round Ø 30
- › **Vertical pipes:** rectangular 8 x 70 mm
- › **Detail work:** radiator made from low-carbon steel with powder coated finish
- › **Standard colours:** white RAL 9003 or anthracite RAL 7016
- › **Mounting:** mounting kit included
- › **Accessories:** radiator bracket enabling mounting to the division wall e.g. plasterboard with ease
- › **Further information:** non-standard size available to order



› **Types of connections:** page 184-185

› **Recommended valves kits** details on pages 178-179

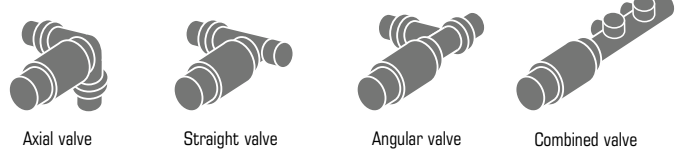
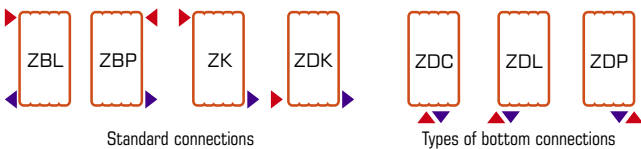

6+2
WARRANTY

2 additional years
of warranty
when purchasing
valves

info@luxrad.com

61

DUCTOR



Height [mm]	Width [mm]	Collector Spacing [mm]	Depth [mm]	Space between wall and power slots [mm]	Radiator Weight [kg]	Radiator capacity [dm ³]	Power level [W] 55/45/20	Power level [W] 75/65/20	Power level [W] 90/70/20
1500	430	50	146	61	16	7.6	324	611	768
1500	550	50	146	61	20.5	9.7	414	781	982
1800	430	50	146	61	19	9.2	388	733	922
1800	550	50	146	61	24	11.8	504	950	1195

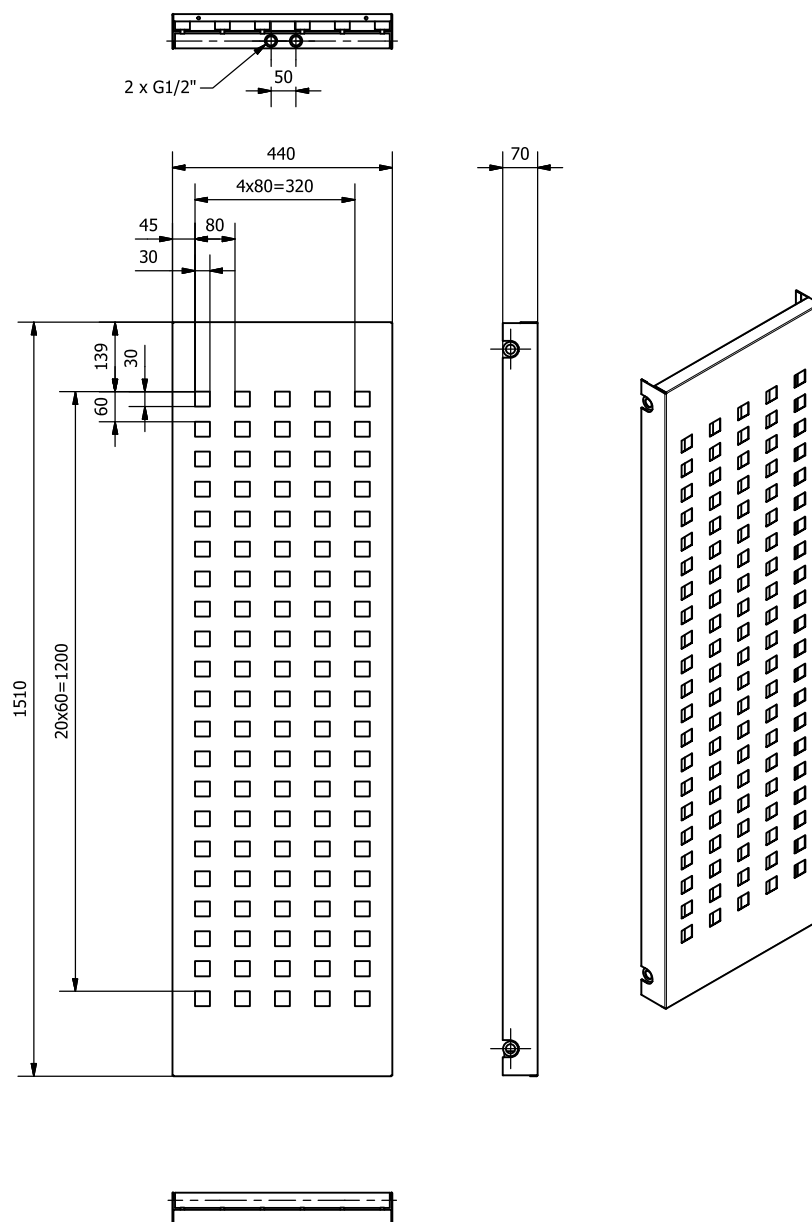

DUCTOR



Radiator which builds atmosphere

DUCTOR radiator has a very specific design. What stands out is its lacquered steel cover on vertical heating profiles with square holes in rows. Vertical profiles behind the cover emit pleasant warmth. Thanks to that, the radiator looks really astonishing and may add a lot of atmosphere in any room.



- › **Horizontal pipes:** round \varnothing 30
- › **Vertical pipes:** square 30 x 30 mm
- › **Cover:** 1,5 mm laser-cut steel pasted on a radiator
- › **Detail work:** radiator made from low-carbon steel with powder coated finish
- › **Standard colours:** white RAL 9003 or anthracite RAL 7016
- › **Mounting:** mounting kit included
- › **Accessories:** radiator bracket ease mounting to the division wall e.g. plasterboard
- › **Further information:** non-standard size available to order



› **Types of connections:** page 184-185

› **Recommended valves kits** details on pages 178-179



Standard



Optional connections



Axial valve



Straight valve



Angular valve



Combined valve

6+2
WARRANTY

2 additional years
of warranty
when purchasing
valves

info@luxrad.com

63

KOBE FULL



Height [mm]	Width [mm]	Collector Spacing [mm]	Depth [mm]	Space between wall and power slots [mm]	Radiator Weight [kg]	Radiator capacity [dm ³]	Power level [W] 55/45/20	Power level [W] 75/65/20	Power level [W] 90/70/20
600	310	500	115	61	8.1	3.9	168	336	422
600	390	500	115	61	10.2	4.9	210	420	528
600	470	500	115	61	12.3	5.9	252	504	634
600	550	500	115	61	13.1	6.3	294	588	739
600	630	500	115	61	16.5	7.9	336	672	845
1100	310	1000	115	61	13.5	6.5	328	648	815
1100	390	1000	115	61	17	8.2	410	810	1018
1100	470	1000	115	61	20.5	9.9	492	972	1222
1100	550	1000	115	61	24	11.6	574	1134	1426
1100	630	1000	115	61	27.5	13.2	656	1296	1630
1500	310	1400	115	61	18.4	8.9	408	808	1016
1500	390	1400	115	61	23.2	11.2	510	1010	1270
1500	470	1400	115	61	27.9	13.5	612	1212	1524
1500	550	1400	115	61	32.7	15.8	714	1414	1778
1500	630	1400	115	61	37.5	18	816	1616	2032
1800	310	1700	115	61	22.1	10.7	496	968	1217
1800	390	1700	115	61	27.8	13.4	620	1210	1522
1800	470	1700	115	61	33.5	16.2	744	1452	1826
1800	550	1700	115	61	39.2	18.9	868	1694	2131
1800	630	1700	115	61	44.9	21.6	992	1936	2435
2000	310	1900	115	61	24.5	11.8	552	1072	1348
2000	390	1900	115	61	30.8	14.9	690	1340	1685
2000	470	1900	115	61	37.1	17.9	828	1608	2022
2000	550	1900	115	61	43.5	21	966	1876	2360
2000	630	1900	115	61	49.8	24.1	1104	2144	2697

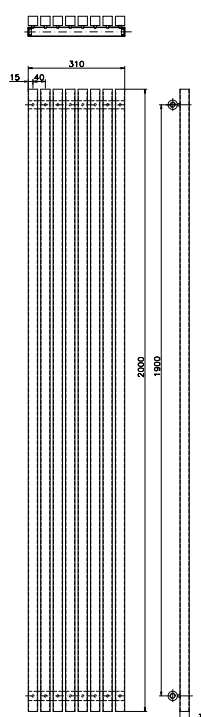
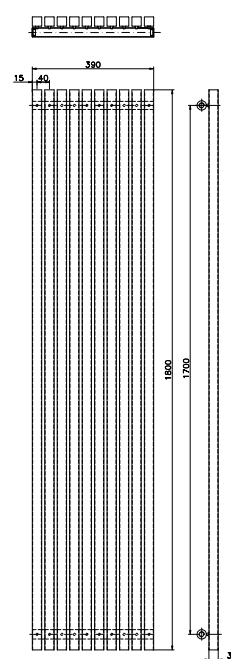
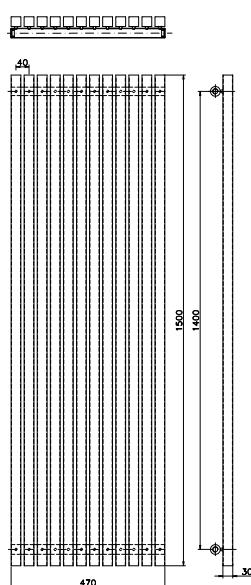
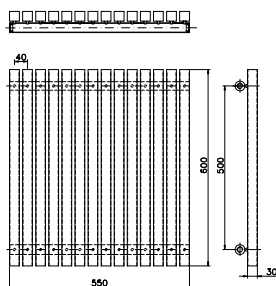

KOBE FULL



Square power

Innovation and functionality in one. Huge power, a range of sizes and modern design allow for Kobe to be flexible in its usage. Adding a rich colour palette gives us a product which will satisfy the tastes of even the most demanding customers.



- › **Horizontal pipes:** round Ø 30
- › **Vertical pipes:** square 30 x 30 mm
- › **Detail work:** radiator made from low-carbon steel with powder coated finish
- › **Standard colours:** white RAL 9003 or anthracite RAL 7016
- › **Mounting:** mounting kit included
- › **Accessories:** radiator bracket enabling mounting to the division wall e.g. plasterboard with ease
- › **Further information:** non-standard size available to order



› **Types of connections:** page 184-185

› **Recommended valves kits** details on pages 178-179

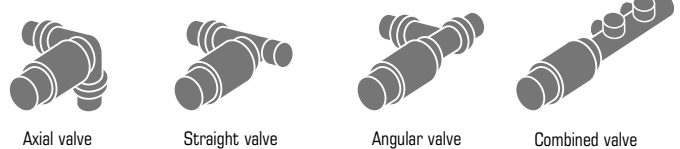
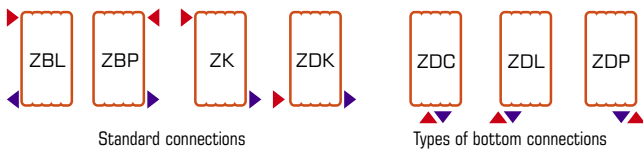

6+2
WARRANTY

2 additional years
of warranty
when purchasing
valves

info@luxrad.com

65

AURORA



Height [mm]	Width [mm]	Collector Spacing [mm]	Depth [mm]	Space between wall and power slots [mm]	Radiator Weight [kg]	Radiator capacity [dm ³]	Power level [W] 55/45/20	Power level [W] 75/65/20	Power level [W] 90/70/20
1000	300	950	105	61	9.4	3.2	213	418	525
1000	390	950	105	61	12.2	4.1	278	544	684
1000	450	950	105	61	14.1	4.8	320	627	788
1000	540	950	105	61	16.9	5.7	385	753	947
1000	600	950	105	61	18.7	6.3	428	837	1052
1500	300	1450	105	61	14.1	4.8	325	627	788
1500	390	1450	105	61	18.3	6.2	424	816	1026
1500	450	1450	105	61	21.1	7.1	489	941	1183
1500	540	1450	105	61	25.3	8.6	587	1130	1421
1500	600	1450	105	61	28.1	9.5	652	1255	1578
1800	300	1750	105	61	16.9	5.7	395	753	947
1800	390	1750	105	61	21.9	7.4	514	980	1232
1800	450	1750	105	61	25.3	8.6	593	1130	1421
1800	540	1750	105	61	30.3	10.3	712	1356	1705
1800	600	1750	105	61	33.7	11.4	791	1507	1895
2000	300	1950	105	61	18.7	6.3	445	836	1051
2000	390	1950	105	61	24.4	8.2	580	1088	1368
2000	450	1950	105	61	28.1	9.5	669	1255	1578
2000	540	1950	105	61	33.7	11.4	803	1506	1894
2000	600	1950	105	61	37.5	12.7	892	1674	2105

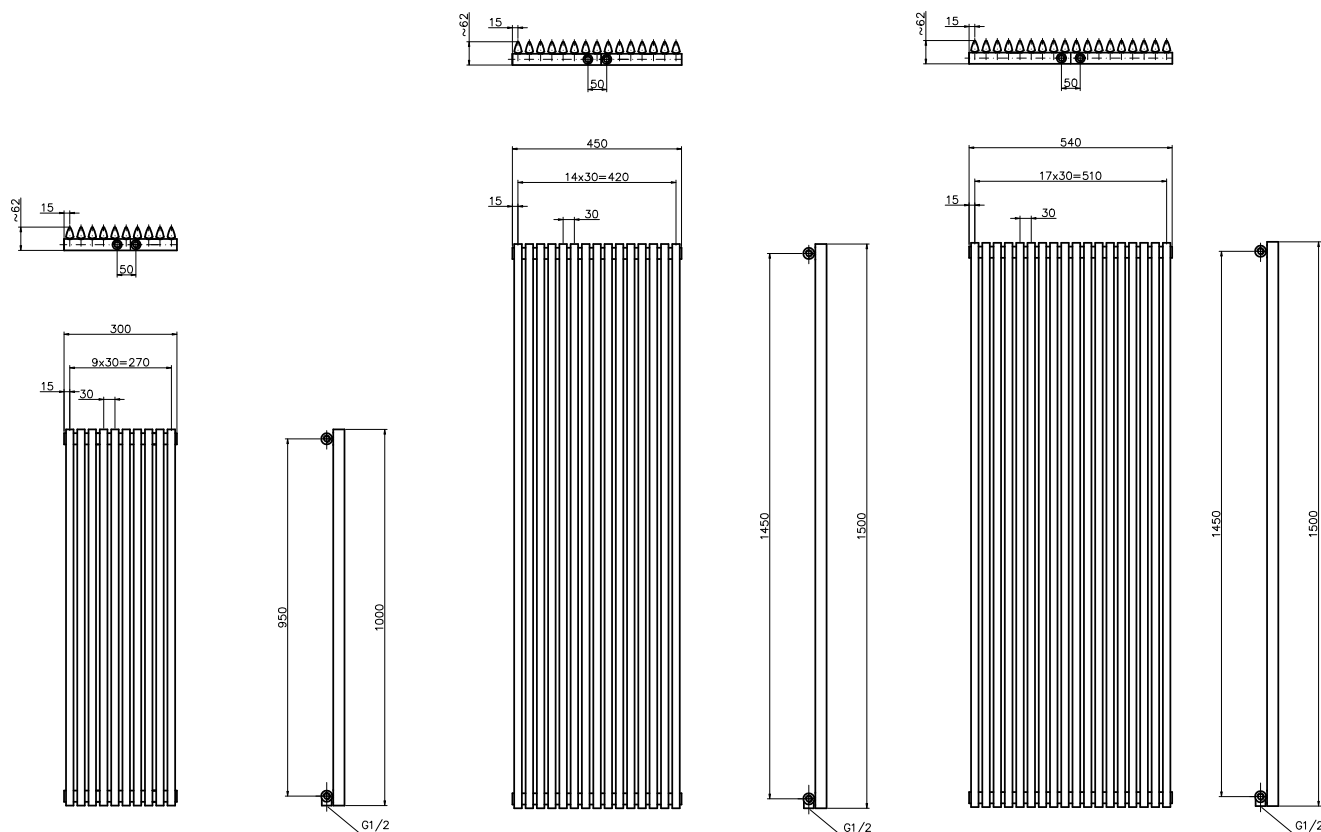

Convex construction

Ultramodern style of Aurora sets new directions for the development of the construction of radiators at the same time ending the stereotypes determined by the appearance of traditional radiators. The triangular construction gives the model a shape that perfectly harmonizes with any interior.



- › **Horizontal pipes:** round Ø 30
- › **Vertical pipes:** triangular 30 x 30 x 20 mm
- › **Detail work:** radiator made from low-carbon steel with powder coated finish
- › **Standard colours:** white RAL 9003 or anthracite RAL 7016
- › **Mounting:** mounting kit included
- › **Accessories:** radiator bracket enabling mounting to the division wall e.g. plasterboard with ease
- › **Further information:** non-standard size available to order. Bottom connections unavailable in horizontal version.



› **Types of connections:** page 184-185

› **Recommended valves kits** details on pages 178-179

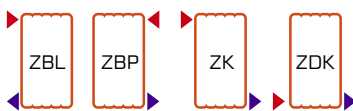

Standard connections



Types of bottom connections



Axial valve



Straight valve



Angular valve



Combined valve

6+2
WARRANTY

2 additional years
of warranty
when purchasing
valves

info@luxrad.com

67

AURORA DOUBLE



Height [mm]	Width [mm]	Collector Spacing [mm]	Depth [mm]	Space between wall and power slots [mm]	Radiator Weight [kg]	Radiator capacity [dm ³]	Power level [W] 55/45/20	Power level [W] 75/65/20	Power level [W] 90/70/20
1000	300	950	105	61	18.7	6.2	339	674	847
1000	390	950	105	61	24.3	8.1	440	876	1102
1000	450	950	105	61	28	9.4	509	1012	1273
1000	540	950	105	61	33.6	11.2	610	1214	1527
1000	600	950	105	61	37.3	12.5	678	1348	1695
1500	300	1450	105	61	27.6	9.2	496	975	1226
1500	390	1450	105	61	35.9	12	645	1267	1593
1500	450	1450	105	61	41.5	13.8	745	1463	1840
1500	540	1450	105	61	49.7	16.5	894	1755	2207
1500	600	1450	105	61	55.3	18.4	993	1950	2453
1800	300	1750	105	61	33	11	587	1136	1429
1800	390	1750	105	61	42.9	14.3	763	1476	1856
1800	450	1750	105	61	49.5	16.4	880	1703	2142
1800	540	1750	105	61	59.4	19.7	1057	2044	2571
1800	600	1750	105	61	66.1	21.9	1174	2271	2856
2000	300	1950	105	61	36.7	12.2	645	1229	1546
2000	390	1950	105	61	47.7	15.9	838	1597	2009
2000	450	1950	105	61	55.1	18.3	968	1844	2319
2000	540	1950	105	61	66.1	22	1161	2212	2782
2000	600	1950	105	61	73.4	24.4	1290	2458	3092

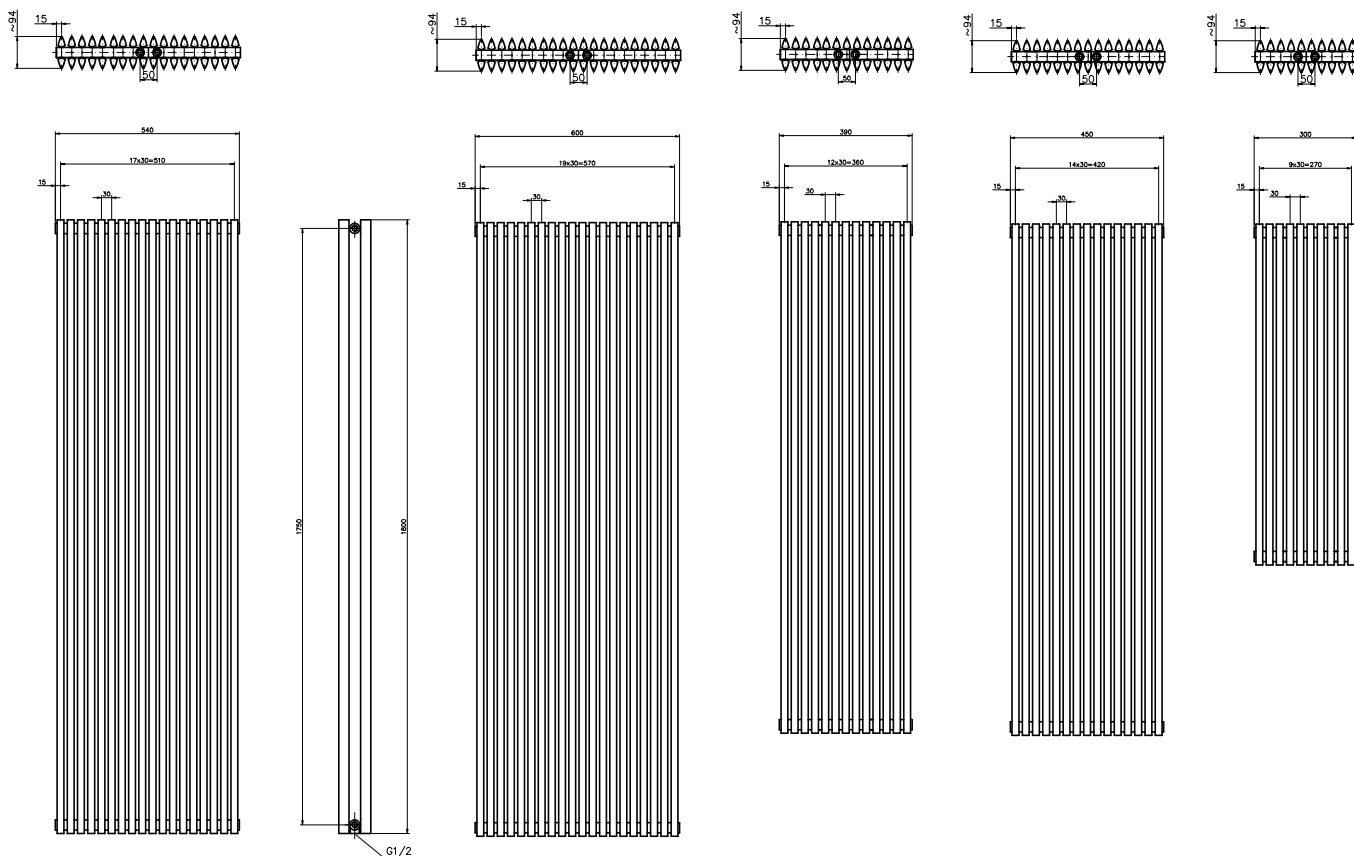

AURORA DOUBLE



Where power also counts

Style and high power will satisfy all needs. Large rooms, living areas and other spaces are no task for AURORA Double.



- › **Horizontal pipes:** round Ø 30
- › **Vertical pipes:** triangular 30 x 30 x 20 mm
- › **Detail work:** radiator made from low-carbon steel with powder coated finish
- › **Standard colours:** white RAL 9003 or anthracite RAL 7016
- › **Mounting:** mounting kit included
- › **Accessories:** radiator bracket enabling mounting to the division wall e.g. plasterboard with ease
- › **Further information:** non-standard size available to order. Bottom connections unavailable in horizontal version.



› **Types of connections:** page 184-185

› **Recommended valves kits** details on pages 178-179

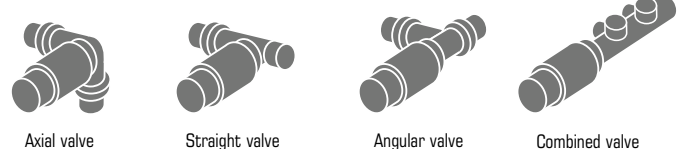
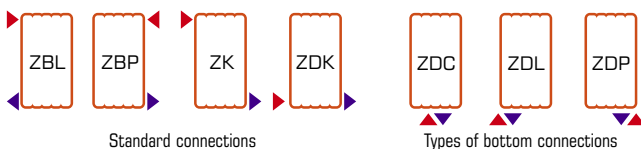

6+2
WARRANTY
2 additional years of warranty when purchasing valves

info@luxrad.com

AURORA CORNER



Height [mm]	Width [mm]	Collector Spacing [mm]	Depth [mm]	Space between wall and power slots [mm]	Radiator Weight [kg]	Radiator capacity [dm ³]	Power level [W] 55/45/20	Power level [W] 75/65/20	Power level [W] 90/70/20
1000	340	50	272	225	11.8	3.8	272	491	617
1500	340	50	272	225	17.7	5.7	408	737	927
1800	340	50	272	225	21.2	6.8	490	884	1112
2000	340	50	272	225	23.6	7.6	544	982	1235

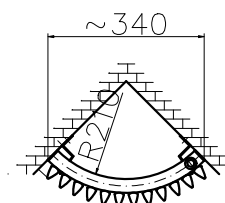
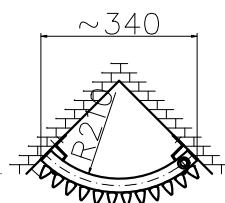
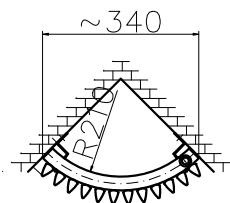
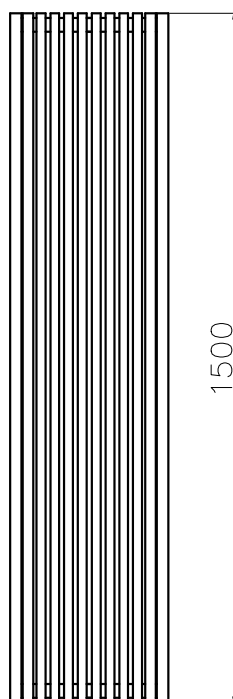
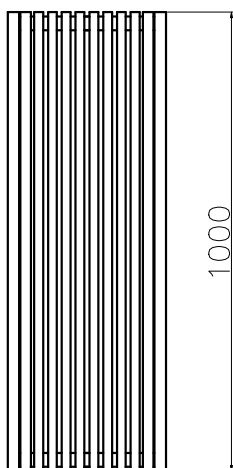
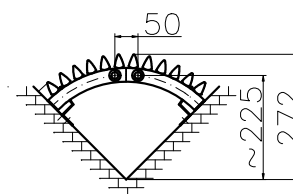
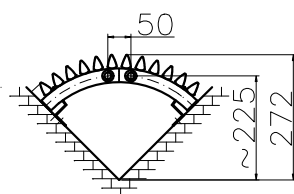
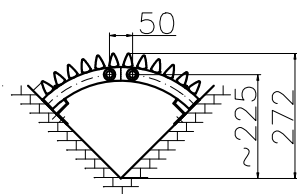

Where the space counts

AURORA CORNER has revolutionised the use of usually unused spaces. From now on, empty corners become useful sources of heat letting the other space to be used in various different ways.



- › **Horizontal pipes:** round Ø 30
- › **Vertical pipes:** triangular 30 x 30 x 20 mm
- › **Detail work:** radiator made from low-carbon steel with powder coated finish
- › **Standard colours:** white RAL 9003 or anthracite RAL 7016
- › **Mounting:** mounting kit included
- › **Accessories:** radiator bracket enabling mounting to the division wall e.g. plasterboard with ease
- › **Further information:** non-standard size available to order. Bottom connections unavailable in horizontal version.



› **Types of connections:** page 184-185

› **Recommended valves kits** details on pages 178-179



Standard



Axial valve



Straight valve



Angular valve

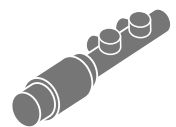

Combined valve

6+2
WARRANTY

2 additional years
of warranty
when purchasing
valves

info@luxrad.com

71

AURORA WITH A MIRROR



Height [mm]	Width [mm]	Collector Spacing [mm]	Depth [mm]	Space between wall and power slots [mm]	Radiator Weight [kg]	Radiator capacity [dm ³]	Power level [W] 55/45/20	Power level [W] 75/65/20	Power level [W] 90/70/20
1800	500	1750	105	61	14	5.9	395	753	947
1800	600	1750	105	61	20.8	7.1	514	980	1232

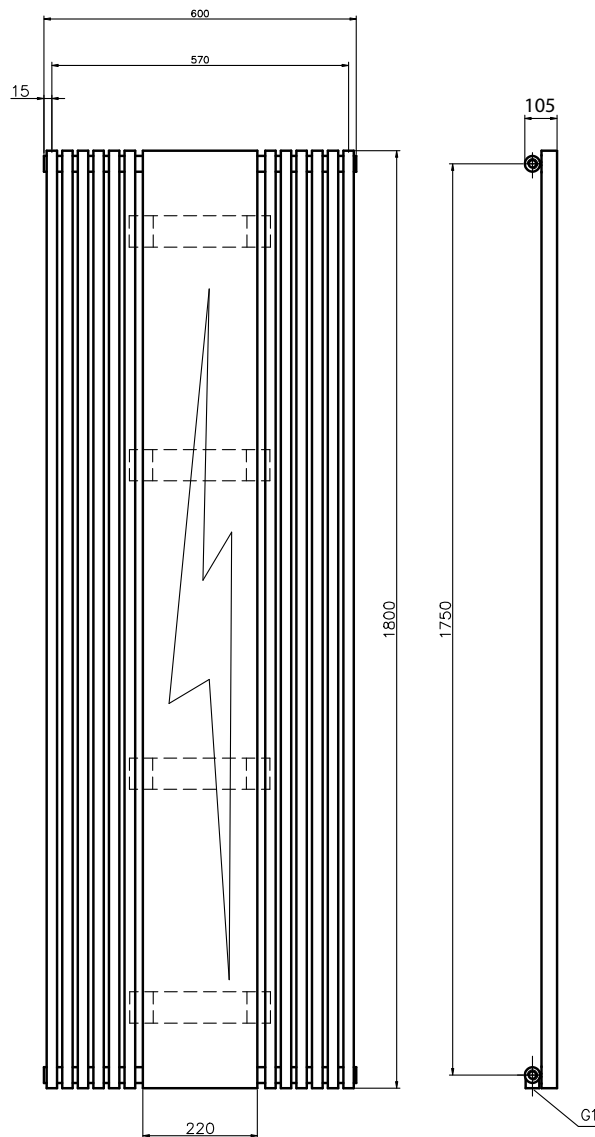
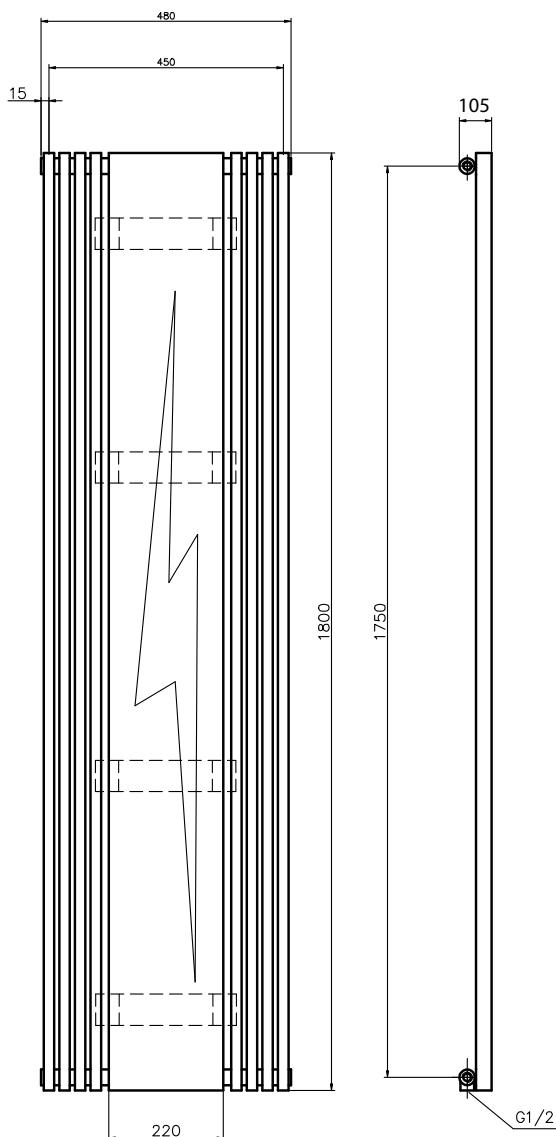
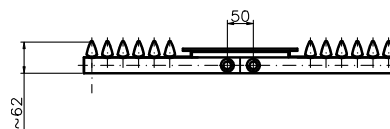
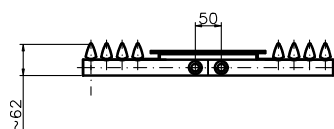

AURORA WITH A MIRROR



Modern and optic

Thanks to the mirror AURORA becomes even more sophisticated. Wherever you place it, you will see yourself as well.



- › **Horizontal pipes:** round Ø 30:
- › **Vertical pipes:** triangular 30 x 30 x 20 mm
- › **Detail work:** radiator made from low-carbon steel with powder coated finish
- › **Mirror:** width 220 mm, arranged centrally
- › **Standard colours:** white RAL 9003 or anthracite RAL 7016
- › **Mounting:** mounting kit included
- › **Accessories:** radiator bracket enabling mounting to the division wall e.g. plasterboard with ease
- › **Further information:** non-standard size available to order. Bottom connections unavailable in horizontal version.



› **Types of connections:** page 184-185

› **Recommended valves kits** details on pages 178-179

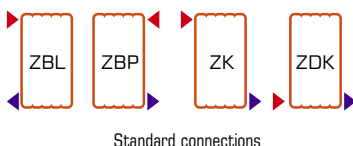

Standard connections

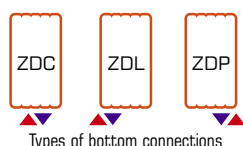

Types of bottom connections



Axial valve



Straight valve



Angular valve



Combined valve

6+2
WARRANTY

2 additional years of warranty when purchasing valves

info@luxrad.com

73

TOBA



Height (mm)	Width (mm)	Collector Spacing (mm)	Depth (mm)	Space between wall and power slots (mm)	Radiator Weight (kg)	Radiator capacity (dm ³)	Power level (W) 55/45/20	Power level (W) 75/65/20	Power level (W) 90/70/20
600	310	550	91	52	4.44	2.7	111	215	270
600	390	550	91	52	5.55	3.4	140	271	340
600	430	550	91	52	6.11	3.7	154	299	376
600	510	550	91	52	7.22	4.4	182	354	445
600	590	550	91	52	8.34	5.1	211	410	515
600	790	550	91	52	11.12	6.8	283	549	690
1000	310	950	91	52	6.91	4.3	186	358	450
1000	390	950	91	52	8.65	5.4	235	451	567
1000	430	950	91	52	9.52	5.9	259	497	625
1000	510	950	91	52	11.25	7	307	590	742
1000	590	950	91	52	12.98	8	356	683	859
1000	790	950	91	52	17.32	10.7	477	915	1151
1200	310	1150	91	52	8.15	5.1	227	430	540
1200	390	1150	91	52	10.2	3.4	286	542	681
1200	430	1150	91	52	11.22	7	315	598	752
1200	510	1150	91	52	13.26	8.2	374	709	891
1200	590	1150	91	52	15.31	9.5	433	820	1031
1200	790	1150	91	52	20.42	12.7	580	1098	1381
1500	310	1450	91	52	10.01	6.2	289	538	676
1500	390	1450	91	52	12.52	7.8	363	677	851
1500	430	1450	91	52	13.77	8.6	401	747	939
1500	510	1450	91	52	16.28	10.2	476	886	1114
1500	590	1450	91	52	18.79	11.7	550	1025	1289
1500	790	1450	91	52	25.06	15.6	737	1373	1727
1800	310	1750	91	52	11.87	7.4	350	646	812
1800	390	1750	91	52	14.84	9.3	441	813	1022
1800	430	1750	91	52	16.33	10.2	486	897	1128
1800	510	1750	91	52	19.3	12.1	577	1064	1338
1800	590	1750	91	52	22.28	13.9	667	1231	1548
1800	790	1750	91	52	29.71	18.6	894	1648	2073

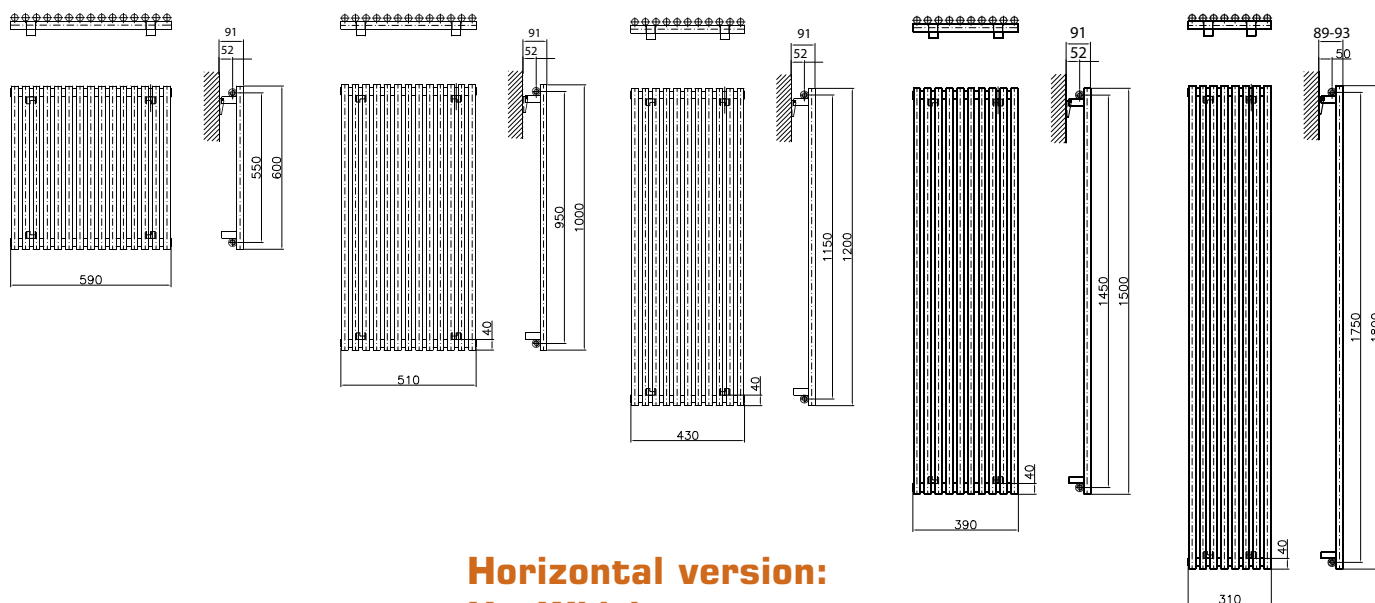

Horizontal version:
H - Width
B - Height

TOBA



Original form and noble influence

Thanks to its design and versatility, this radiator provides endless mounting possibilities. A large selection of Toba dimensions is their great advantage. The horizontal version is a logical fulfillment and continuation in the range of cylindrical radiators. It enriches the form of interiors, satisfying all demands.



- › **Horizontal pipes:** round Ø 30
- › **Vertical pipes:** round Ø 25
- › **Detail work:** radiator made from low-carbon steel with powder coated finish
- › **Standard colours:** white RAL 9003 or anthracite RAL 7016
- › **Mounting:** mounting kit included
- › **Accessories:** radiator bracket enabling mounting to the division wall e.g. plasterboard with ease
- › **Further information:** non-standard size available to order.



› **Types of connections:** page 184-185

› **Recommended valves kits** details on pages 178-179

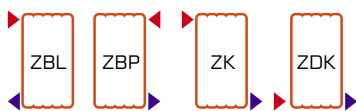

Standard connections



Types of bottom connections



Axial valve



Straight valve



Angular valve

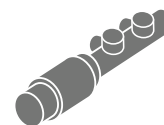

Combined valve

6+2
WARRANTY

2 additional years
of warranty
when purchasing
valves

info@luxrad.com

75

TOBA DOUBLE



Height [mm]	Width [mm]	Collector Spacing [mm]	Depth [mm]	Space between wall and power slots [mm]	Radiator Weight [kg]	Radiator capacity [dm ³]	Power level [W] 55/45/20	Power level [W] 75/65/20	Power level [W] 90/70/20
600	310	550	95	57	8.15	5.1	169	331	416
600	390	550	95	57	10.2	6.3	213	417	524
600	430	550	95	57	11.22	7	235	460	578
600	510	550	95	57	13.26	8.2	278	545	685
600	590	550	95	57	15.31	9.8	322	631	793
600	790	550	95	57	20.42	12.7	432	845	1063
1000	310	950	95	57	13.11	8.2	284	552	694
1000	390	950	95	57	16.39	10.3	358	695	874
1000	430	950	95	57	18.03	11.3	395	766	963
1000	510	950	95	57	21.32	13.3	469	909	1143
1000	590	950	95	57	24.6	15.4	543	1052	1323
1000	790	950	95	57	32.81	20.5	726	1408	1771
1200	310	1150	95	57	15.59	9.8	346	663	834
1200	390	1150	95	57	19.49	12.2	436	834	1049
1200	430	1150	95	57	21.44	13.4	481	920	1157
1200	510	1150	95	57	25.34	15.9	570	1091	1372
1200	590	1150	95	57	29.25	18.3	660	1262	1587
1200	790	1150	95	57	39	24.5	883	1690	2126
1500	310	1450	95	57	19.3	12.1	440	829	1042
1500	390	1450	95	57	24.14	15.2	554	1043	1312
1500	430	1450	95	57	26.55	16.7	611	1150	1446
1500	510	1450	95	57	31.38	19.7	725	1364	1715
1500	590	1450	95	57	36.22	22.8	839	1578	1985
1500	790	1450	95	57	48.3	30.4	1123	2113	2658
1800	310	1750	95	57	23.02	14.5	534	995	1251
1800	390	1750	95	57	28.78	18.1	672	1252	1575
1800	430	1750	95	57	31.66	19.9	741	1380	1736
1800	510	1750	95	57	37.42	23.6	879	1637	2059
1800	590	1750	95	57	43.19	27.2	1017	1894	2382
1800	790	1750	95	57	57.59	36.2	1362	2536	3190

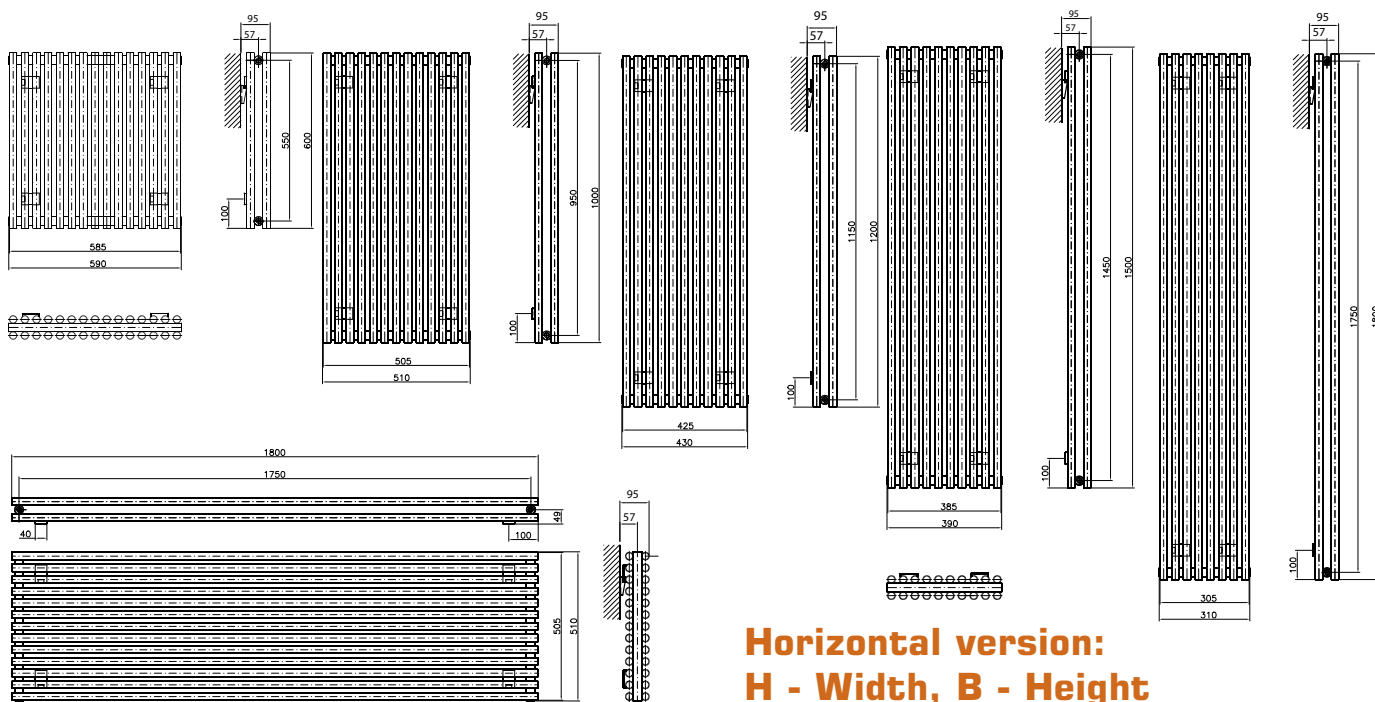

Horizontal version:
H - Width, B - Height

TOBA DOUBLE



Double round pipes

Exceptionally high efficiency will satisfy the most refined expectations, in both the single and double versions of this product. With additional connections alongside with a selection of colours, the possibilities are endless.



- › **Horizontal pipes:** round Ø 30
- › **Vertical pipes:** round Ø 25
- › **Detail work:** radiator made from low-carbon steel with powder coated finish
- › **Standard colours:** white RAL 9003 or anthracite RAL 7016
- › **Mounting:** mounting kit included
- › **Accessories:** radiator bracket enabling mounting to the division wall e.g. plasterboard with ease
- › **Further information:** non-standard size available to order



› **Types of connections:** page 184-185

› **Recommended valves kits** details on pages 178-179

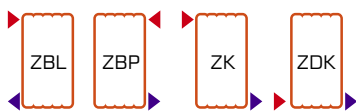

Standard connections



Types of bottom connections



Axial valve



Straight valve



Angular valve

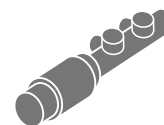

Combined valve

6+2
WARRANTY

2 additional years
of warranty
when purchasing
valves

info@luxrad.com

CHEBBI



Height [mm]	Width [mm]	Collector Spacing [mm]	Depth [mm]	Space between wall and power slots [mm]	Radiator Weight [kg]	Radiator capacity [dm ³]	Power level [W] 55/45/20	Power level [W] 75/65/20	Power level [W] 90/70/20
1500	290	1450	87	52	10.7	4.9	311	586	737
1500	440	1450	87	52	16.1	7.5	466	879	1105
1500	590	1450	87	52	21.4	10.1	605	1141	1435
1800	290	1750	87	52	12.9	6	374	706	888
1800	440	1750	87	52	19.4	9.1	561	1059	1332
1800	590	1750	87	52	25.8	12.2	728	1375	1729

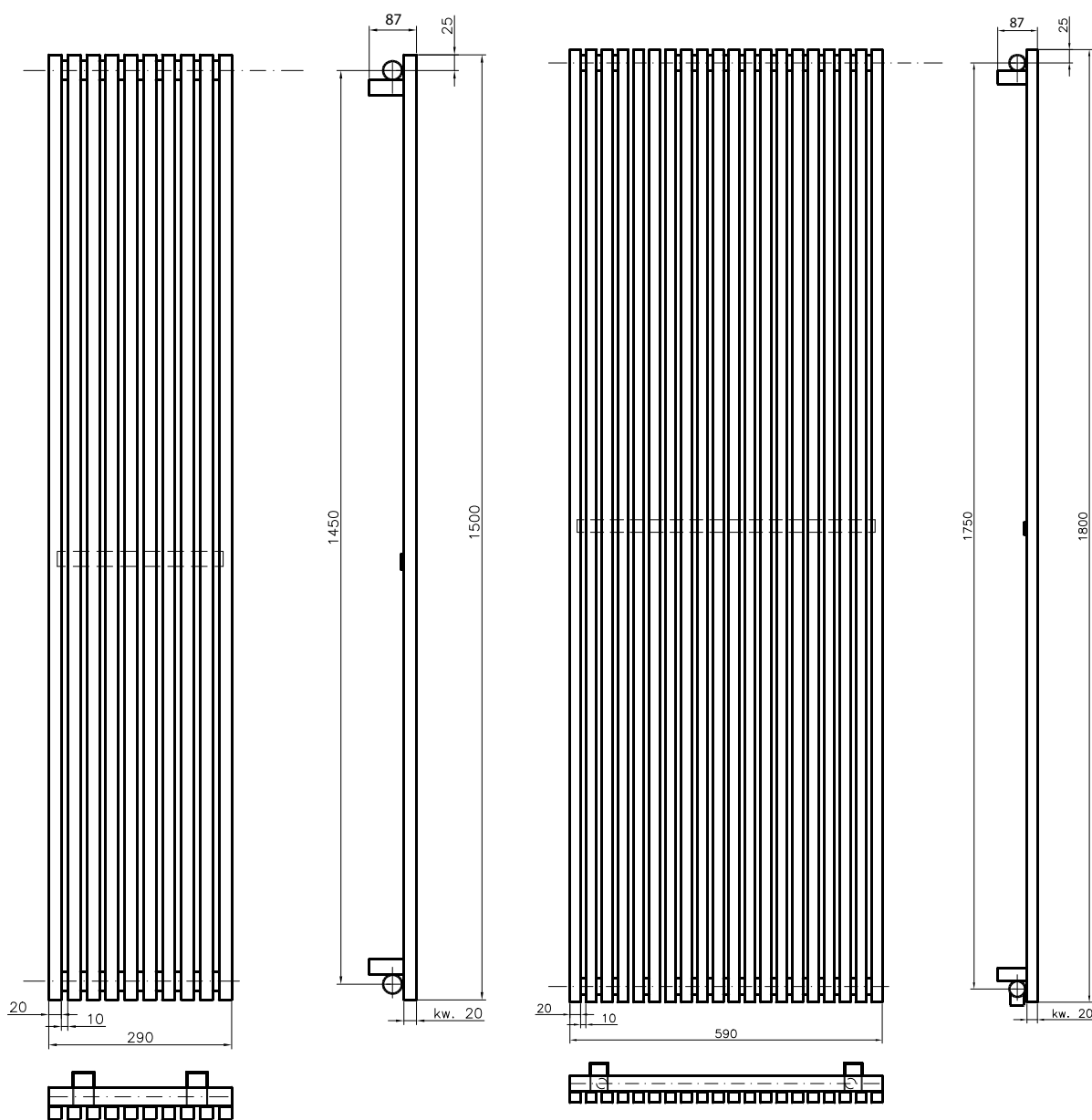

Pure and simple

Inspired by modern architecture - combined vertical square pipes give this radiator a characteristic sharp and minimalistic profile. A high standard and ideal source of heat, quality and aesthetics for the demanding individual. It also convinces through its heat efficient which really makes an impression.



- › **Horizontal pipes:** round Ø 30
- › **Vertical pipes:** square 20 x 20 mm
- › **Detail work:** radiator made from low-carbon steel with powder coated finish
- › **Standard colours:** white RAL 9003 or anthracite RAL 7016
- › **Mounting:** mounting kit included
- › **Accessories:** radiator bracket enabling mounting to the division wall e.g. plasterboard with ease
- › **Further information:** non-standard size available to order.



› **Types of connections:** page 184-185

› **Recommended valves kits** details on pages 178-179

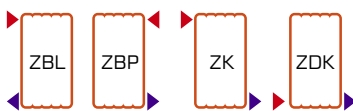

Standard connections



Types of bottom connections



Axial valve



Straight valve



Angular valve

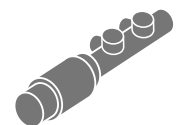

Combined valve

6+2
WARRANTY

2 additional years
of warranty
when purchasing
valves

info@luxrad.com

79

SETTINGS

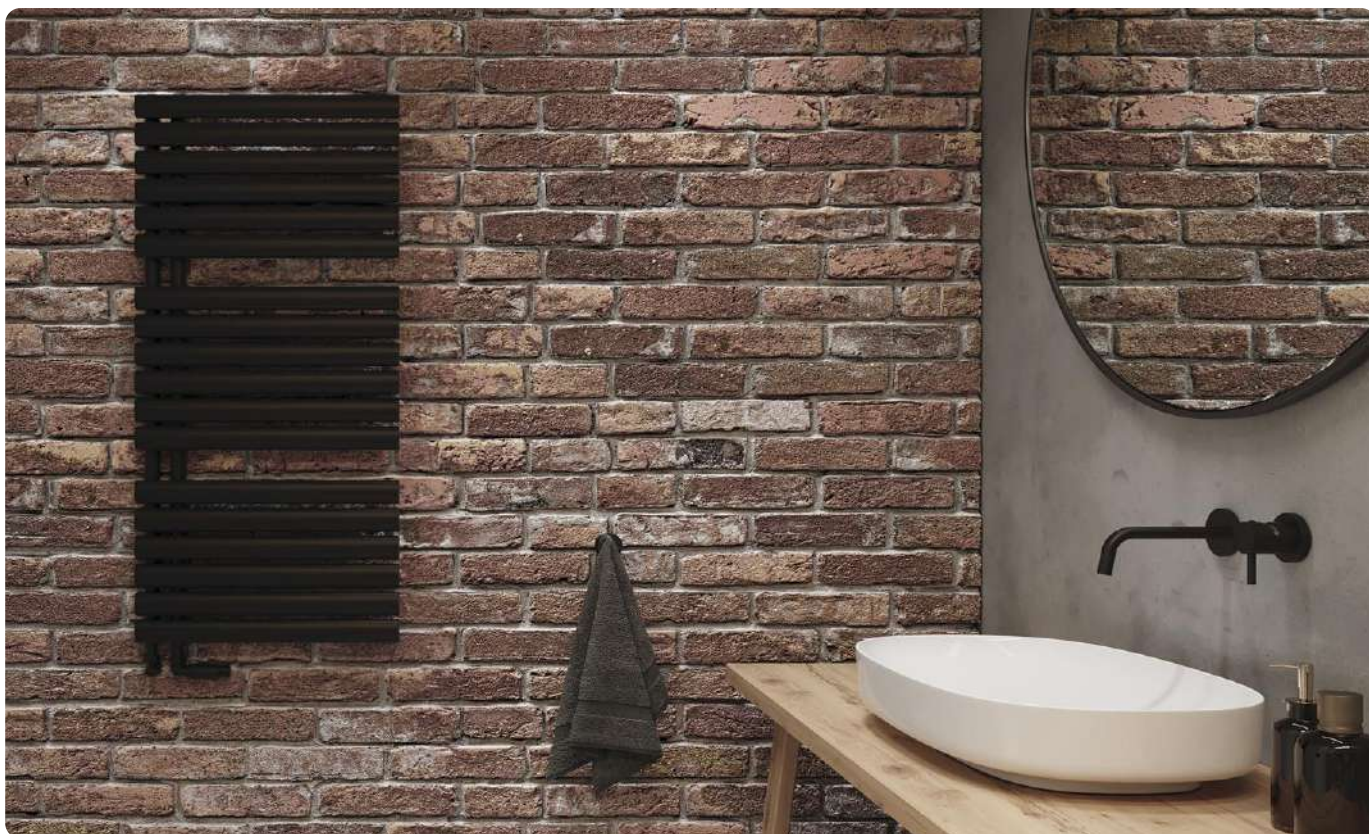

SETTINGS



6+2
WARRANTY

2 additional years
of warranty
when purchasing
valves

info@luxrad.com



BATHROOM RADIATORS

● OPTIMUS	84-85
● ATRIA	86-87
● CALIDO	88-89
● NEBRASKA	90-91
● SCALA NEW	92-93
● NEO	94-95
● ATAKAMA	96-97
● FLAG BIS	98-99
● NEPTUN	100-101
● MODEL E	102-103
● MODEL E COVERED	104-105
● TYP E	106-107
● ELEGANT	108-109
● POLLUX	110-111
● GOCTA	112-113
● PIKO	114-115
● MERKURY	116-117
● JUPITER	118-119
● KASTOR	120-121
● SALTO	122-123
● SALTO MAX	124-125
● SALTO I	126-127
● OVALTIC	128-129
● OVALTIC COVER	130-131
● KILE	132-133
● MARS	134-135
● KWADRO	136-137
● ELIPSO	138-139
● BARVA	140-141
● GAJA	142-143
● SATURN	144-145
● REGULAR	146-147
● REGULAR-G	148-149

OPTIMUS



Height [mm]	Width [mm]	Collector Spacing [mm]	Depth [mm]	Space between wall and power slots [mm]	Radiator Weight [kg]	Radiator capacity [dm ³]	Power level [W] 55/45/20	power level [W] 75/65/20	Power level [W] 90/70/20
626	450	400	136-146	46-56	5.8	2.1	167	310	389
626	550	500	136-146	46-56	6.6	2.5	204	379	476
934	450	400	136-146	46-56	8.4	3.1	249	462	581
934	550	500	136-146	46-56	9.4	3.8	305	565	710
934	650	600	136-146	46-56	10.5	4.5	360	668	840
1242	450	400	136-146	46-56	10.9	4.1	332	615	773
1242	550	500	136-146	46-56	12.3	5.1	405	751	944
1242	650	600	136-146	46-56	13.7	6	479	888	1117
1682	550	500	136-146	46-56	16.7	6.9	549	1017	1279
1682	650	600	136-146	46-56	18.6	8.1	649	1202	1512

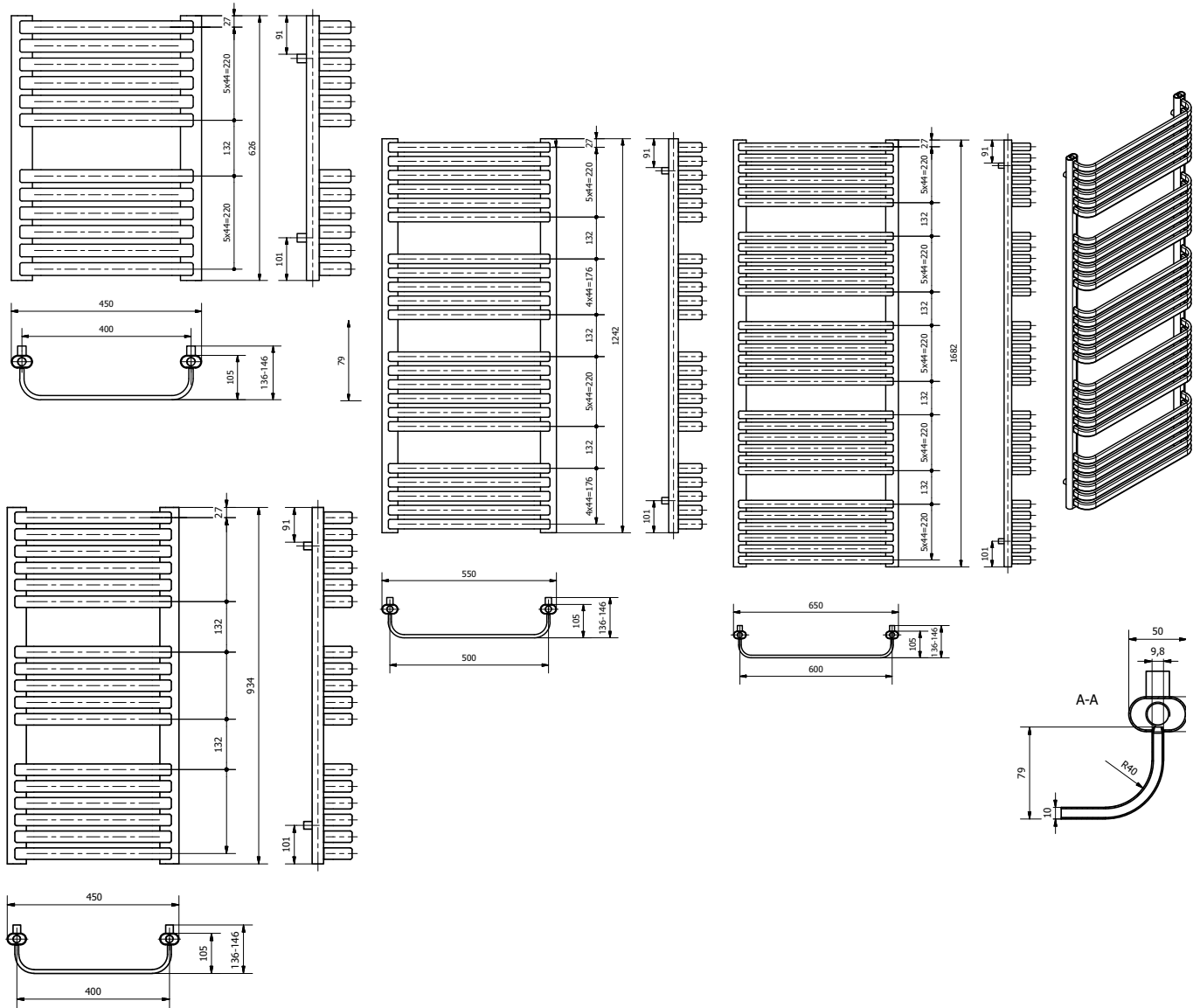

OPTIMUS



Elegance and minimalism

Simple and elegant design. Oval, vertical pipes connected to flat, horizontal profiles give the heater its characteristic, modern shape. Additionally, thanks to the use of 90° bends and maintaining the correct spacing it has a delicate look to it.



- › **Vertical pipes:** oval 2 x D
- › **Horizontal pipes:** oval flat 30 x 10 mm
- › **Detail work:** low-carbon steel, powder coated finish
- › **Standard colours:** white RAL 9003 or anthracite RAL 7016
- › **Mounting:** mounting kit included
- › **Other informations:** non-standard sizes available to order



› **Types of connections:** page 184-185

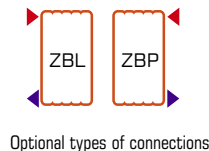
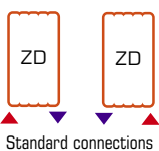

› **Recommended valves kits** details on pages 178-179



6+2
WARRANTY

2 additional years
of warranty
when purchasing
valves

info@luxrad.com

85

ATRIA



Height [mm]	Width [mm]	Collector Spacing [mm]	Depth [mm]	Space between wall and power slots [mm]	Radiator Weight [kg]	Radiator capacity [dm ³]	Power level [W] 55/45/20	power level [W] 75/65/20	Power level [W] 90/70/20
870	500	50	61-71	46-56	6.1	3	136	252	317
870	600	50	61-71	46-56	7	3.5	157	291	366
870	700	50	61-71	46-56	7	3.9	177	329	413
1230	500	50	61-71	46-56	8.5	4.2	189	350	440
1230	600	50	61-71	46-56	9.8	4.8	217	403	506
1230	700	50	61-71	46-56	11	5.4	246	456	573
1470	500	50	61-71	46-56	10	5	224	415	522
1470	600	50	61-71	46-56	11.6	5.7	258	478	601
1470	700	50	61-71	46-56	13	6.4	291	540	679
1710	500	50	61-71	46-56	11.6	5.7	259	481	605
1710	600	50	61-71	46-56	13.4	6.6	298	553	695
1710	700	50	61-71	46-56	15.1	7.5	337	625	786

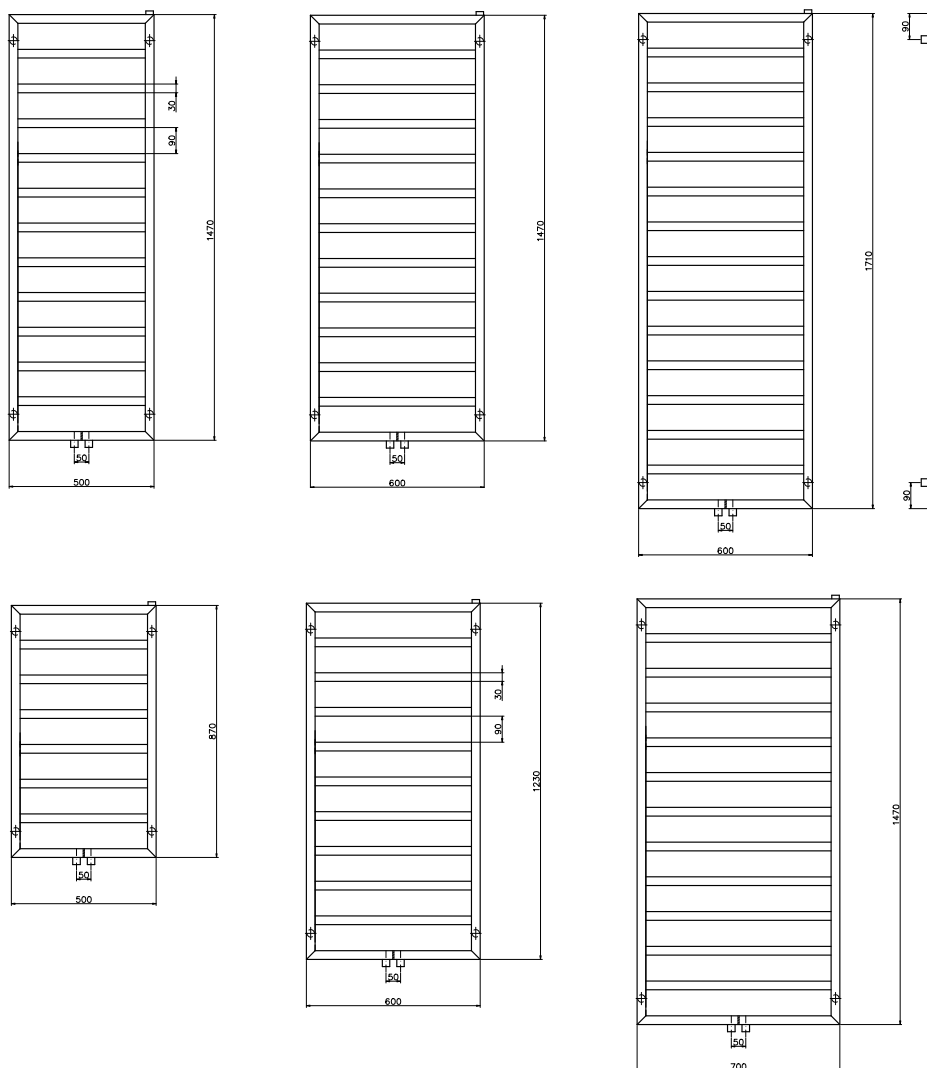

Well-formed and practical

The design and detail work of Atria enhances the atmosphere of every bathroom. Its appearance and practicality will find its place in any home.



- › **Vertical pipes:** square 30 x 30 mm
- › **Horizontal pipes:** square 30 x 30 mm
- › **Detail work:** radiator made from low-carbon steel with powder coated finish
- › **Standard colours:** white RAL 9003 or anthracite RAL 7016
- › **Mounting:** mounting kit included
- › **Further information:** non standard size, heater assembly or electric heater available to order



› **Types of connections:** page 184-185

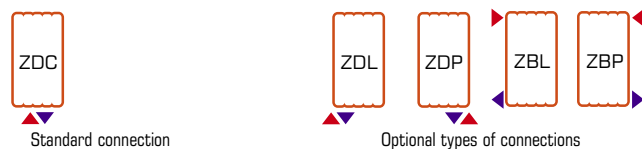

› **Recommended valves kits** details on pages 178-179

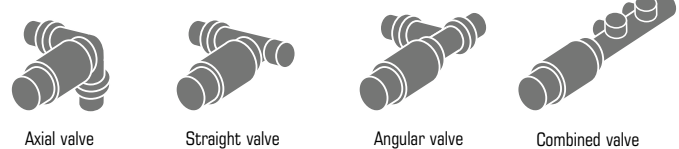

6+2
WARRANTY
2 additional years of warranty when purchasing valves

info@luxrad.com

CALIDO



Height [mm]	Width [mm]	Collector Spacing [mm]	Depth [mm]	Space between wall and power slots [mm]	Radiator Weight [kg]	Radiator capacity [dm ³]	Power level [W] 55/45/20	power level [W] 75/65/20	Power level [W] 90/70/20
740	500	450	107-117	45-55	9.8	3.5	235	437	549
740	600	550	107-117	45-55	11.4	4	275	511	642
740	700	650	107-117	45-55	13	4.6	315	584	734
1160	500	450	107-117	45-55	15.7	5.6	379	702	883
1160	600	550	107-117	45-55	18.3	6.5	442	820	1031
1160	700	650	107-117	45-55	20.9	7.3	506	938	1180
1460	500	450	107-117	45-55	20	7.1	482	893	1123
1460	600	550	107-117	45-55	23.3	8.2	563	1044	1313
1460	700	650	107-117	45-55	26.6	9.3	645	1195	1503
1760	500	450	107-117	45-55	23.4	8.4	563	1044	1313
1760	600	550	107-117	45-55	27.3	9.6	658	1219	1533
1760	700	650	107-117	45-55	31.1	10.9	753	1395	1754

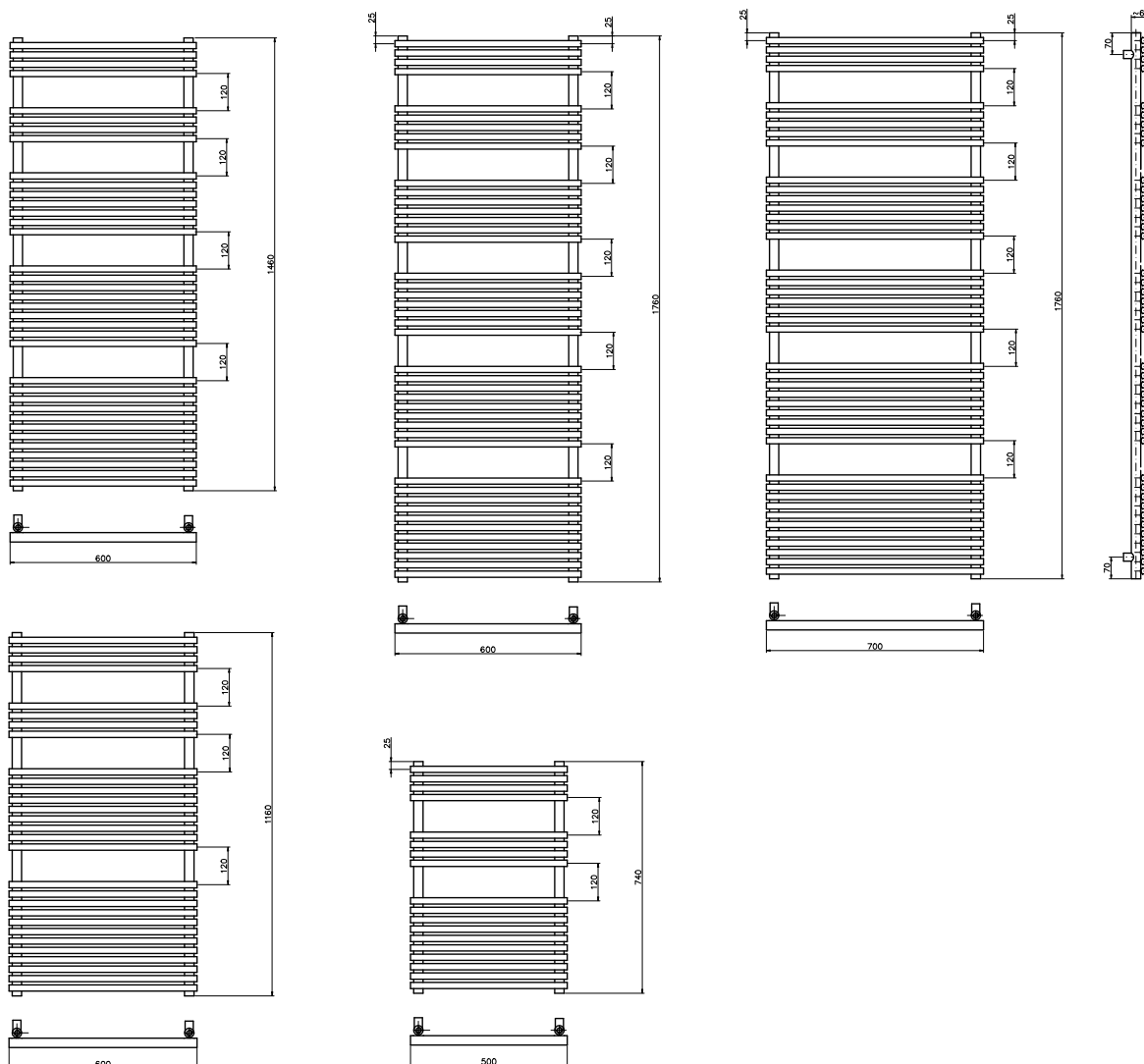

Sharp as triangle

A visual sharpness is attained by the arrangement of triangular vertical pipes mounted on rounded collectors. Calido is sophisticated in its design, often chosen by designers who wish to enhance the individuality of a specific room.



- › **Vertical pipes:** square 30 x 30 mm
- › **Horizontal straight pipes:** triangular 30 x 30 x 20 mm
- › **Detail work:** radiator made from low-carbon steel with powder coated finish
- › **Standard colours:** white RAL 9003 or anthracite RAL 7016
- › **Mounting:** mounting kit included
- › **Further information:** non standard size, heater assembly or electric heater available to order



› **Types of connections:** page 184-185

› **Recommended valves kits** details on pages 178-179

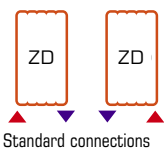

Standard connections

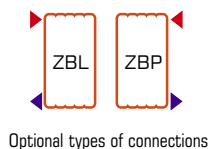

Optional types of connections



Axial valve



Straight valve



Angular valve

6+2
WARRANTY

2 additional years
of warranty
when purchasing
valves

NEBRASKA



Height [mm]	Width [mm]	Collector Spacing [mm]	Depth [mm]	Space between wall and power slots [mm]	Radiator Weight [kg]	Radiator capacity [dm ³]	Power level [W] 55/45/20	power level [W] 75/65/20	Power level [W] 90/70/20
970	500	450	69-79	46-56	11.8	3.8	272	505	635
970	600	550	69-79	46-56	13.7	4.3	312	579	728
1420	500	450	69-79	46-56	17.6	5.6	392	727	914
1420	600	550	69-79	46-56	20.5	6.4	450	834	1049
1795	500	450	69-79	46-56	23.3	7.4	505	936	1177
1795	600	550	69-79	46-56	27.1	8.5	581	1076	1353

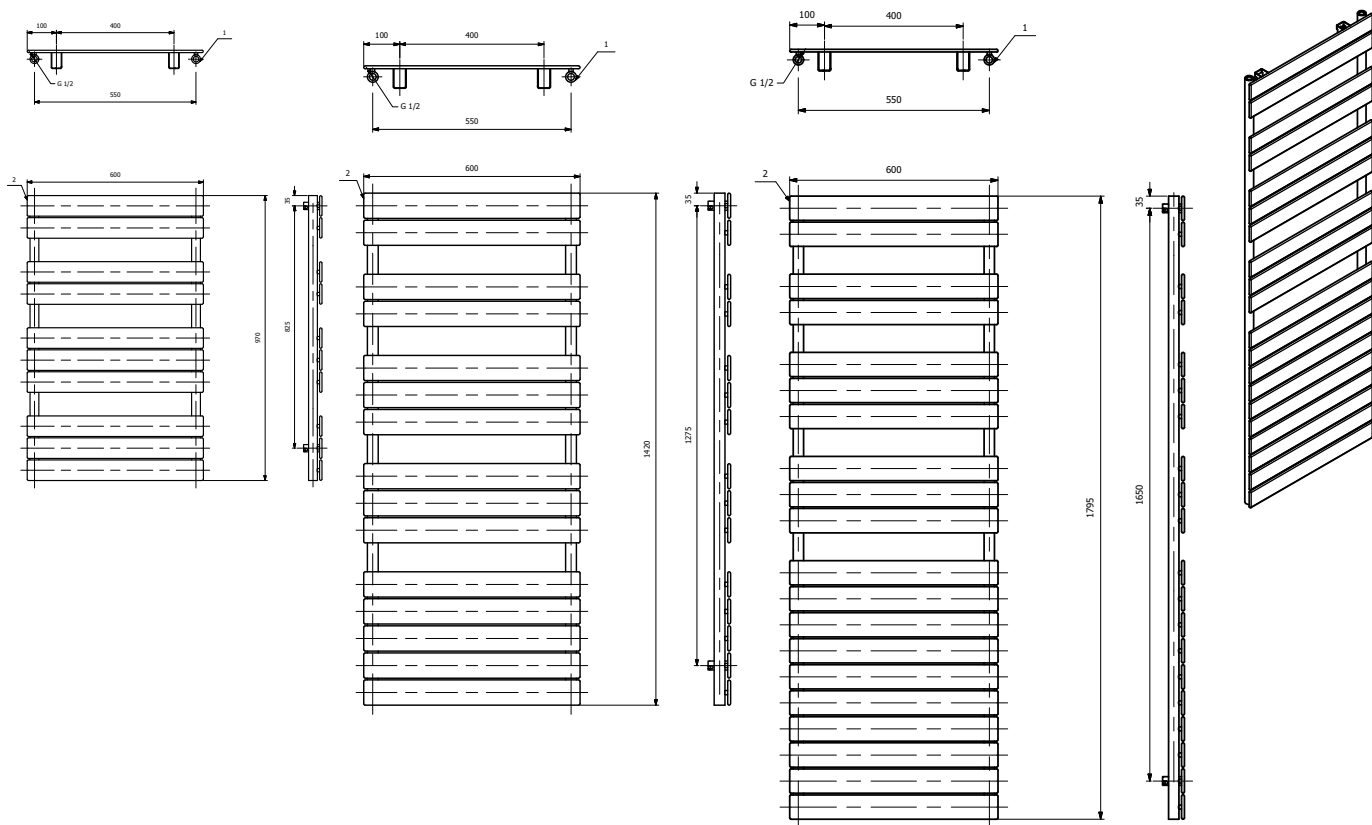

NEBRASKA



Distinctive flat look

Balanced, harmonious form and flat pipes characteristics give this fashionable bathroom radiator an exceptional modern appearance.



- › **Vertical pipes:** round Ø 30
- › **Horizontal pipes:** rectangular 8 x 70 mm
- › **Detail work:** radiator made from low-carbon steel with powder coated finish
- › **Standard colours:** white RAL 9003 or anthracite RAL 7016
- › **Mounting:** mounting kit included
- › **Further information:** non standard size, heater assembly or electric heater available to order



› **Types of connections:** page 184-185

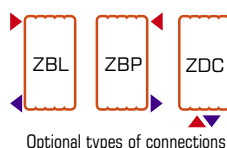
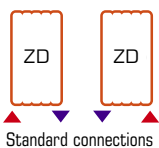

› **Recommended valves kits** details on pages 178-179

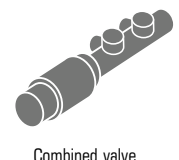

Axial valve

Straight valve

Angular valve

Combined valve

6+2
WARRANTY

2 additional years
of warranty
when purchasing
valves

info@luxrad.com

91

SCALA NEW



Height [mm]	Width [mm]	Collector Spacing [mm]	Depth [mm]	Space between wall and power slots [mm]	Radiator Weight [kg]	Radiator capacity [dm ³]	Power level [W] 55/45/20	power level [W] 75/65/20	Power level [W] 90/70/20
840	400	370	79-89	46-56	5.8	2.3	160	298	374
840	500	470	79-89	46-56	6.7	2.7	201	373	469
1230	400	370	79-89	46-56	8.4	3.4	235	437	549
1230	500	470	79-89	46-56	9.6	3.9	294	546	686

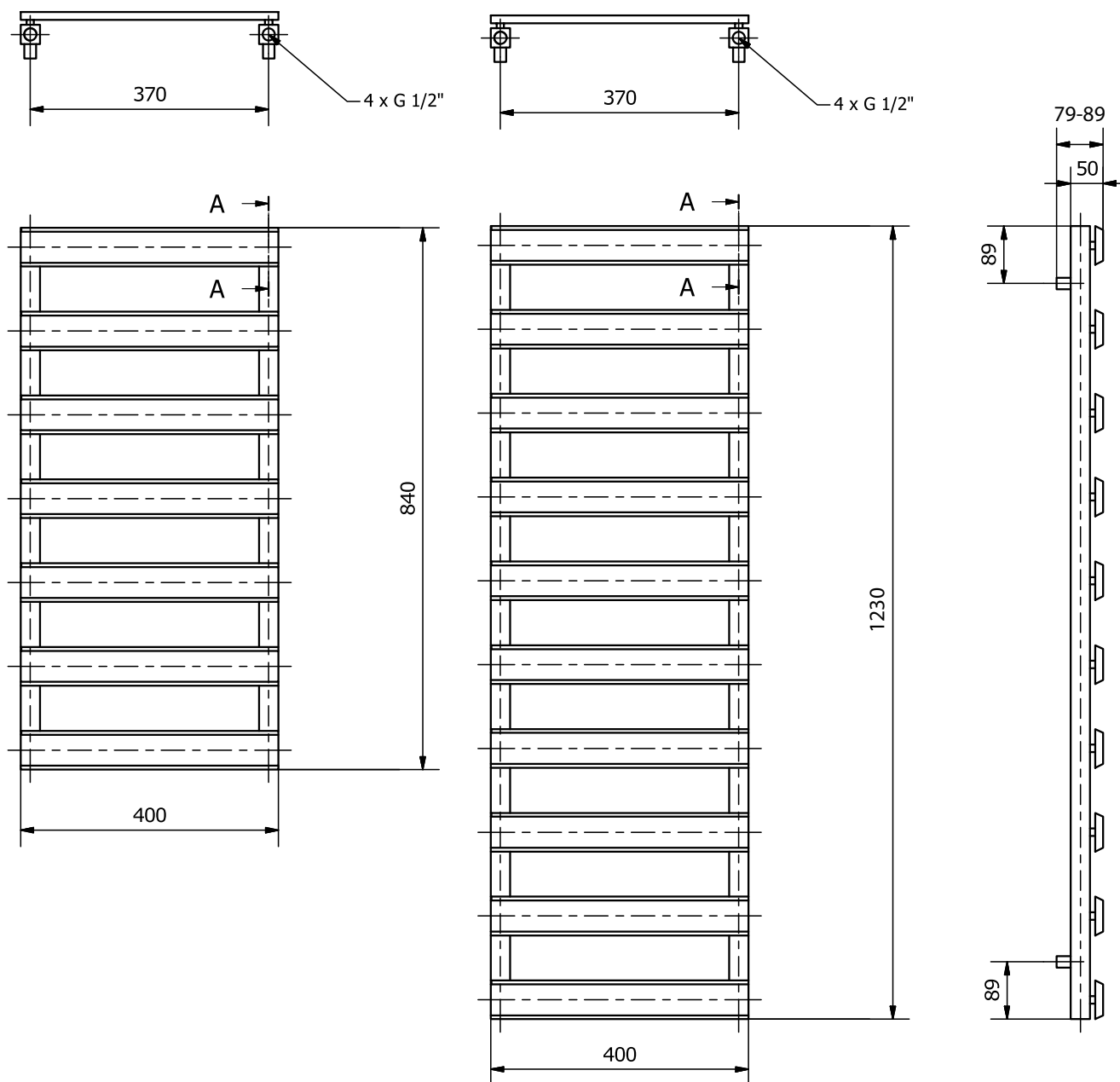

SCALA NEW



A timeless classic

SCALA NEW thanks to its simple form perfectly complements the interior of the bathroom. Functionality thanks to the flat profile makes this product really practical and gives many possibilities of use. RAL colour system and special colours are available for this product so there are no need to worry about color matching.



- › **Vertical pipes:** square 30 x 50 mm
- › **Horizontal pipes:** trapezoidal shape 12 x 60 mm
- › **Detail work:** radiator made from low-carbon steel with powder coated finish
- › **Standard colours:** white RAL 9003 or anthracite RAL 7016
- › **Further information:** heater assembly or non-standard size available to order



› **Types of connections:** page 184-185

› **Recommended valves kits** details on pages 178-179

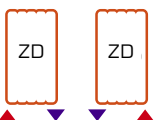

Standard connections

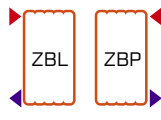

Optional types of connections



Axial valve



Straight valve



Angular valve

6+2
WARRANTY

2 additional years
of warranty
when purchasing
valves

info@luxrad.com

93

NEO



Height [mm]	Width [mm]	Collector Spacing [mm]	Depth [mm]	Space between wall and power slots [mm]	Radiator Weight [kg]	Radiator capacity [dm ³]	Power level [W] 55/45/20	power level [W] 75/65/20	Power level [W] 90/70/20
816	500	450	102-112	62-72	8.5	5.4	228	423	532
816	600	550	102-112	62-72	9.8	6.3	265	491	617
816	700	650	102-112	62-72	11	7.1	302	560	704
1164	500	450	102-112	62-72	12.3	7.8	331	613	771
1164	600	550	102-112	62-72	14.2	9.1	385	713	896
1164	700	650	102-112	62-72	16.2	10.4	439	813	1022
1570	500	450	102-112	62-72	16.5	10.6	449	832	1046
1570	600	550	102-112	62-72	20.2	12.9	548	1015	1276
1570	700	650	102-112	62-72	23	14.8	625	1159	1458
1802	500	450	102-112	62-72	19.2	12.2	515	955	1201
1802	600	550	102-112	62-72	22.2	14.2	600	1112	1398
1802	700	650	102-112	62-72	25.2	16.2	685	1269	1596

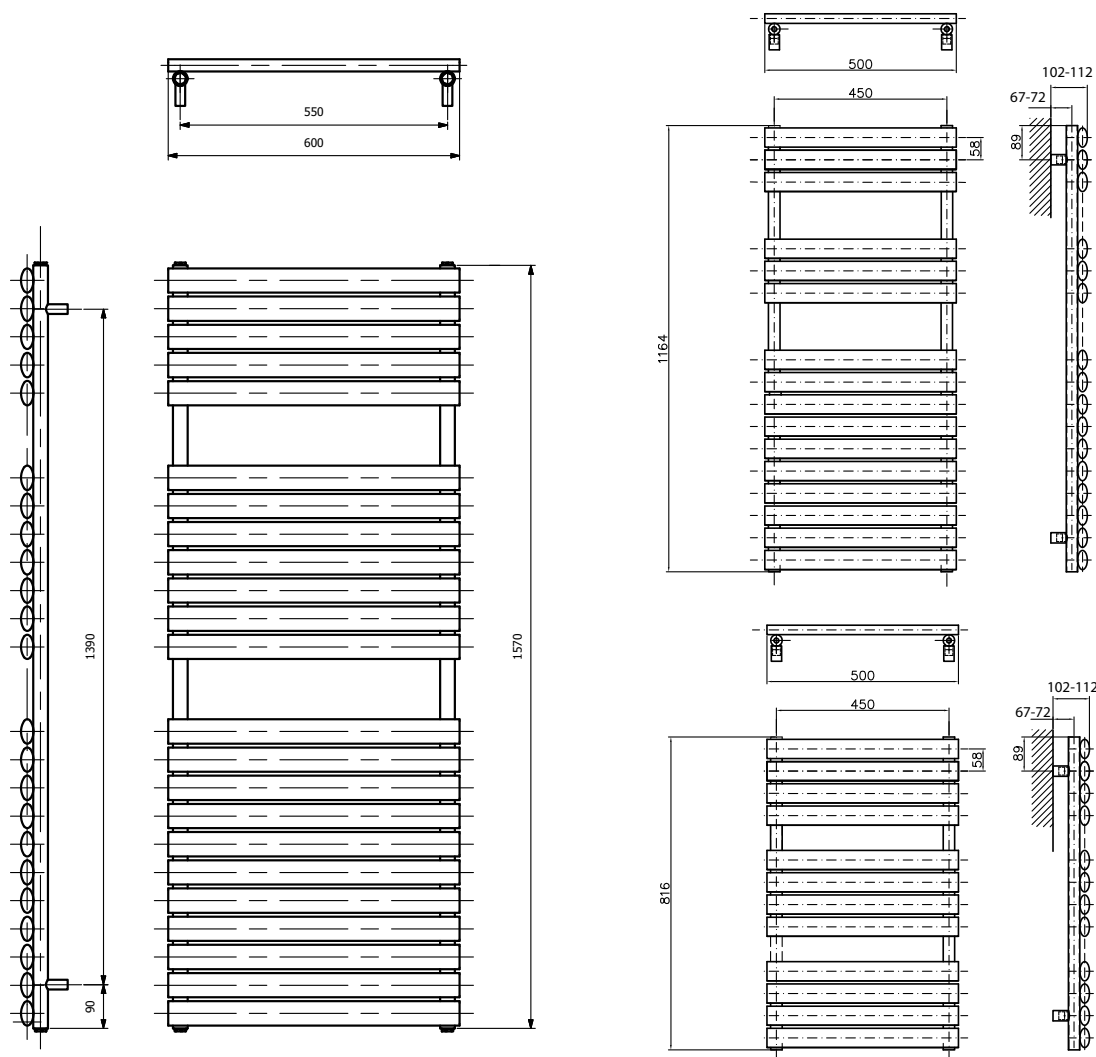

Ladders with class

NEO is the highest level of beauty. Its modern design will perfectly match with elegant interiors in Your house.



- › **Vertical pipes:** round Ø 30
- › **Horizontal pipes:** elliptic 25 x 50 mm
- › **Detail work:** radiator made from low-carbon steel with powder coated finish
- › **Standard colours:** white RAL 9003 or anthracite RAL 7016
- › **Mounting:** mounting kit included
- › **Further information:** non standard size, heater assembly or electric heater available to order



Warranty



Maximum temperature



Maximum work pressure



Electric version available



Hydro-electric version available



Additional hangers

› **Types of connections:** page 184-185

› **Recommended valves kits** details on pages 178-179

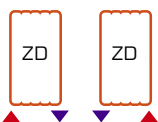

Standard connections

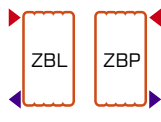

Optional types of connections



Axial valve



Straight valve



Angular valve

6+2
WARRANTY

2 additional years of warranty when purchasing valves

info@luxrad.com

95

ATAKAMA



Height [mm]	Width [mm]	Collector Spacing [mm]	Depth [mm]	Space between wall and power slots [mm]	Radiator Weight [kg]	Radiator capacity [dm3]	Power level [W] 55/45/20	power level [W] 75/65/20	Power level [W] 90/70/20
745	500	50	85-95	62-72	7.8	2	202	375	471
745	600	50	85-95	62-72	8	2.3	235	436	548
745	700	50	85-95	62-72	10.2	2.5	268	497	625
1195	500	50	85-95	62-72	13.3	3.4	348	646	812
1195	600	50	85-95	62-72	15.4	3.8	406	752	946
1195	700	50	85-95	62-72	17.5	4.3	463	859	1080
1495	500	50	85-95	62-72	15.5	4.1	405	751	944
1495	600	50	85-95	62-72	17.9	4.5	470	872	1096
1495	700	50	85-95	62-72	20.3	5	536	994	1250
1720	500	50	85-95	62-72	17.8	4.5	467	865	1088
1720	600	50	85-95	62-72	20.6	5.1	544	1009	1269
1720	700	50	85-95	62-72	23.5	5.6	622	1153	1450

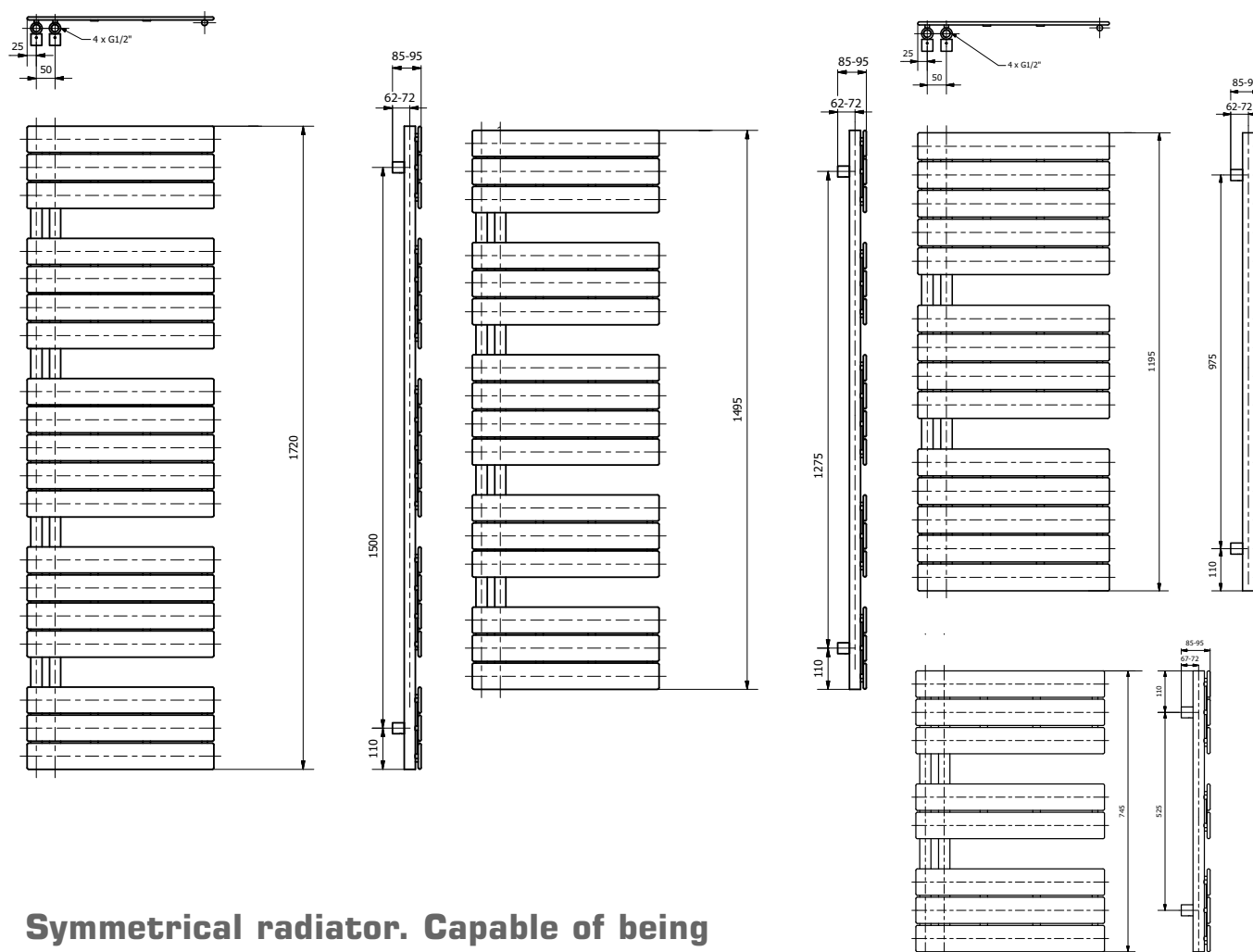

Symmetrical radiator. Capable of being mounted with collectors on the right or left side.

Discreet charm

A proven and elegant panel design suits perfectly in the bathroom. This variety of panel radiators provides for a huge amount of possibilities and configurations in any room setting.



- › **Vertical pipes:** round Ø 30
- › **Horizontal pipes:** rectangular 8 x 70 mm
- › **Detail work:** radiator made from low-carbon steel with powder coated finish
- › **Standard colours:** white RAL 9003 or anthracite RAL 7016
- › **Mounting:** mounting kit included
- › **Further information:** non-standard size available to order



› **Types of connections:** page 184-185

› **Recommended valves kits** details on pages 178-179

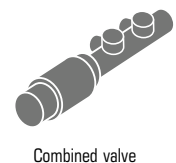
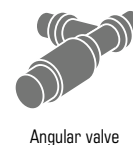
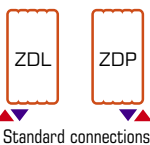

6+2
WARRANTY

2 additional years of warranty when purchasing valves

info@luxrad.com

97

FLAG BIS



Height [mm]	Width [mm]	Collector Spacing [mm]	Depth [mm]	Space between wall and power slots [mm]	Radiator Weight [kg]	Radiator capacity [dm ³]	Power level [W] 55/45/20	power level [W] 75/65/20	Power level [W] 90/70/20
816	500	50	102-112	62-72	9.1	5.8	245	454	571
816	600	50	102-112	62-72	10.5	6.7	285	529	665
1164	500	50	102-112	62-72	13.5	8.6	364	675	849
1164	600	50	102-112	62-72	15.7	10	425	788	991
1512	500	50	102-112	62-72	17.9	11.4	483	896	1127
1512	600	50	102-112	62-72	20.8	13.4	565	1047	1317
1802	500	50	102-112	62-72	21	13.4	566	1049	1319
1802	600	50	102-112	62-72	24.4	15.6	661	1225	1541

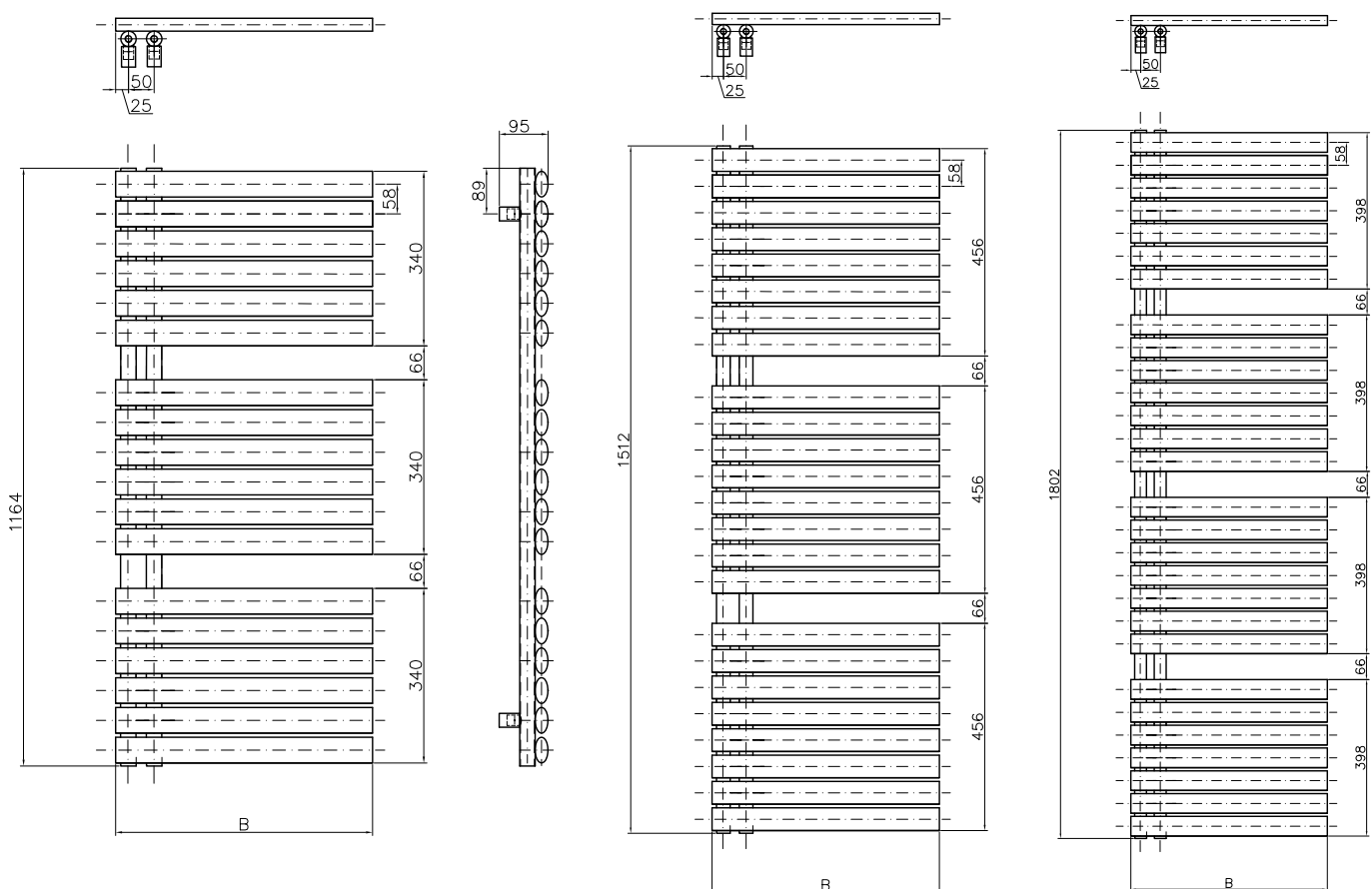

Symmetrical radiator. Capable of being mounted with collectors on the right or left side.

FLAG BIS



Discover luxury

FLAG BIS, thanks to horizontal, round pipes, may be as well a decorative element of any bathroom. Variety of sizes provides with needed flexibility.



- › **Vertical pipes:** round \varnothing 30
- › **Horizontal pipes:** elliptic 25 x 50 mm
- › **Detail work:** radiator made from low-carbon steel with powder coated finish
- › **Standard colours:** white RAL 9003 or anthracite RAL 7016
- › **Mounting:** mounting kit included
- › **Further information:** non-standard size available to order



› **Types of connections:** page 184-185

› **Recommended valves kits** details on pages 178-179

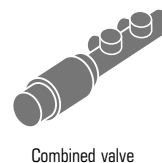
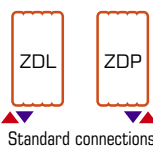

6+2
WARRANTY

2 additional years
of warranty
when purchasing
valves

info@luxrad.com

99

NEPTUN



Height [mm]	Width [mm]	Collector Spacing [mm]	Depth [mm]	Space between wall and power slots [mm]	Radiator Weight [kg]	Radiator capacity [dm ³]	Power level [W] 55/45/20	power level [W] 75/65/20	Power level [W] 90/70/20
430	650	120	72-91	39-58	2.9	1.4	101	188	236
652	650	120	72-91	39-58	4.4	2.1	146	272	342
874	650	120	72-91	39-58	5.9	2.8	191	354	445
1096	650	120	72-91	39-58	7.4	3.5	234	434	545
1318	650	120	72-91	39-58	8.9	4.2	277	513	645
1540	650	120	72-91	39-58	10.3	4.9	318	590	742
1762	650	120	72-91	39-58	11.8	5.6	360	667	839

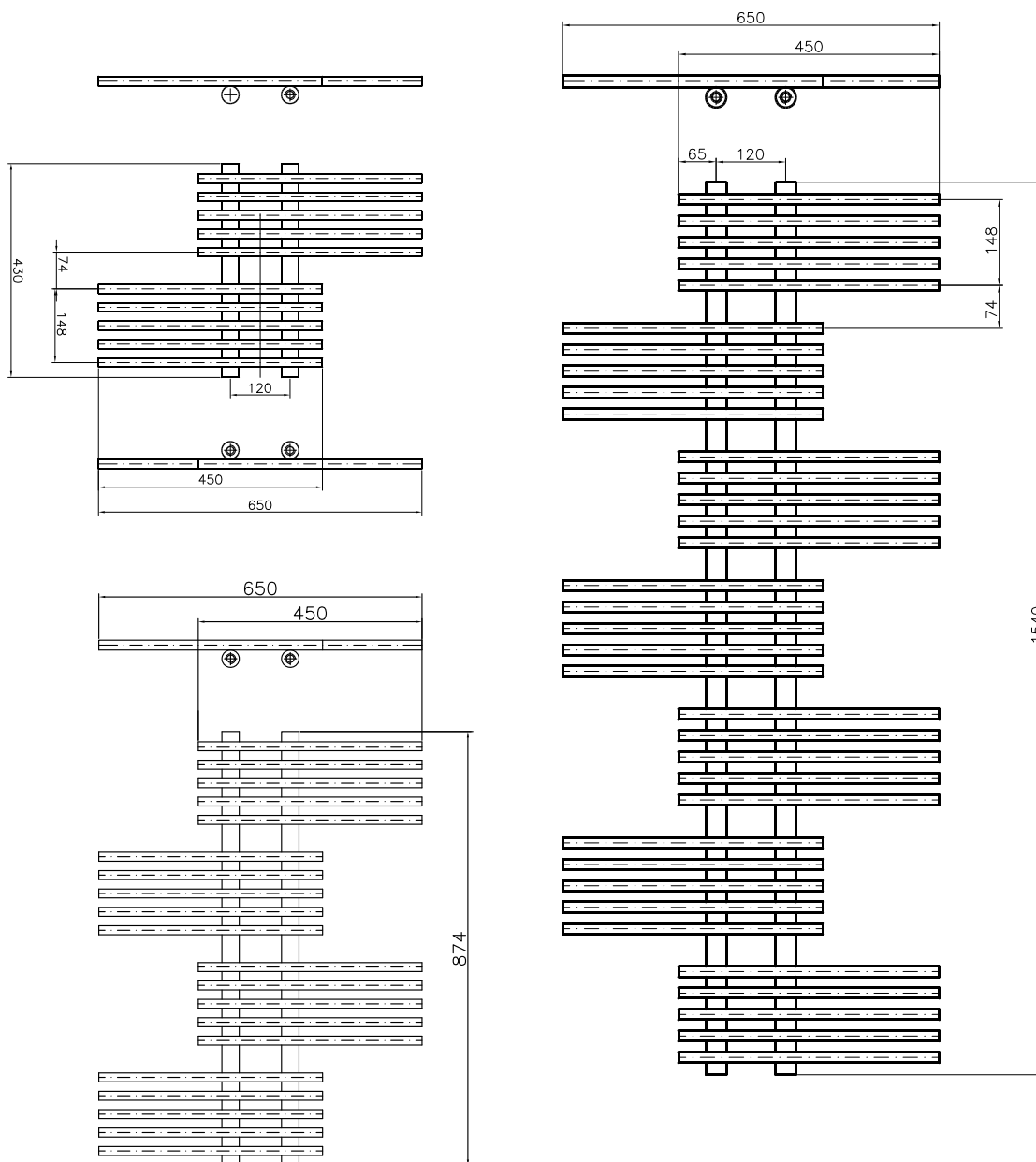

Creative design

A characteristic feature of this model is the alternating sequences of horizontal pipes. It makes Neptun to gain a peculiar dynamism without its losing the distinctness of the line. This attractive radiator will delight everyone who, with a taste for simplicity, is looking for something extraordinary.

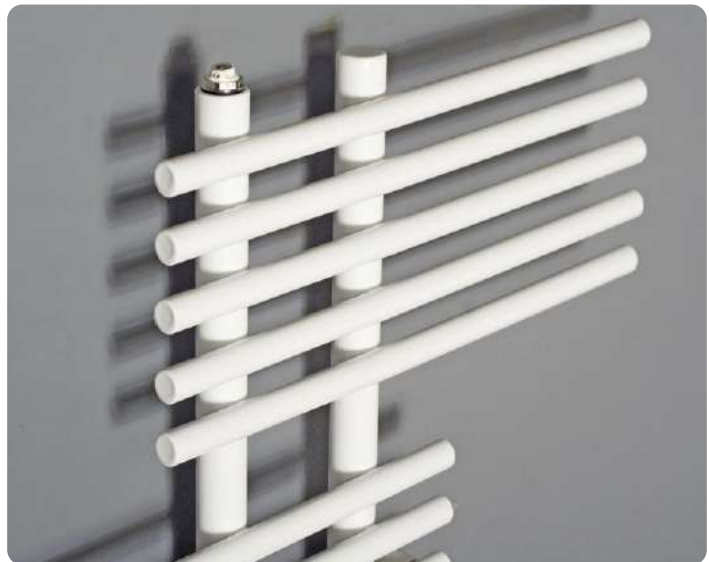

- › **Vertical pipes:** round Ø 30
- › **Horizontal pipes:** round Ø18
- › **Detail work:** radiator made from low-carbon steel with powder coated finish
- › **Standard colours:** white RAL 9003 or anthracite RAL 7016
- › **Mounting:** mounting kit included
- › **Further information:** non standard size, heater assembly or electric heater available to order



› **Types of connections:** page 184-185

› **Recommended valves kits** details on pages 178-179

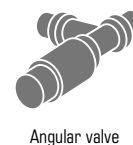
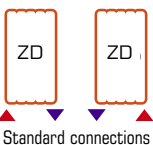

6+2
WARRANTY

2 additional years
of warranty
when purchasing
valves

info@luxrad.com

101

MODEL E



Height [mm]	Width [mm]	Collector Spacing [mm]	Depth [mm]	Space between wall and power slots [mm]	Radiator Weight [kg]	Radiator capacity [dm ³]	Power level [W] 55/45/20	power level [W] 75/65/20	Power level [W] 90/70/20
827	400	50	105-115	62-72	5.7	3.2	186	345	434
827	500	50	105-115	62-72	6.7	3.7	218	404	508
827	600	50	105-115	62-72	7.7	4.3	250	463	582
1271	400	50	105-115	62-72	8.9	4.9	277	514	646
1271	500	50	105-115	62-72	10.4	5.8	325	603	758
1271	600	50	105-115	62-72	12	6.7	372	690	868
1567	400	50	105-115	62-72	11.3	6.3	346	641	806
1567	500	50	105-115	62-72	13.3	7.4	406	752	946
1567	600	50	105-115	62-72	15.2	8.5	465	862	1084
1789	400	50	105-115	62-72	12.7	7	382	709	891
1789	500	50	105-115	62-72	14.8	8.2	448	831	1045
1789	600	50	105-115	62-72	17	9.5	514	952	1197

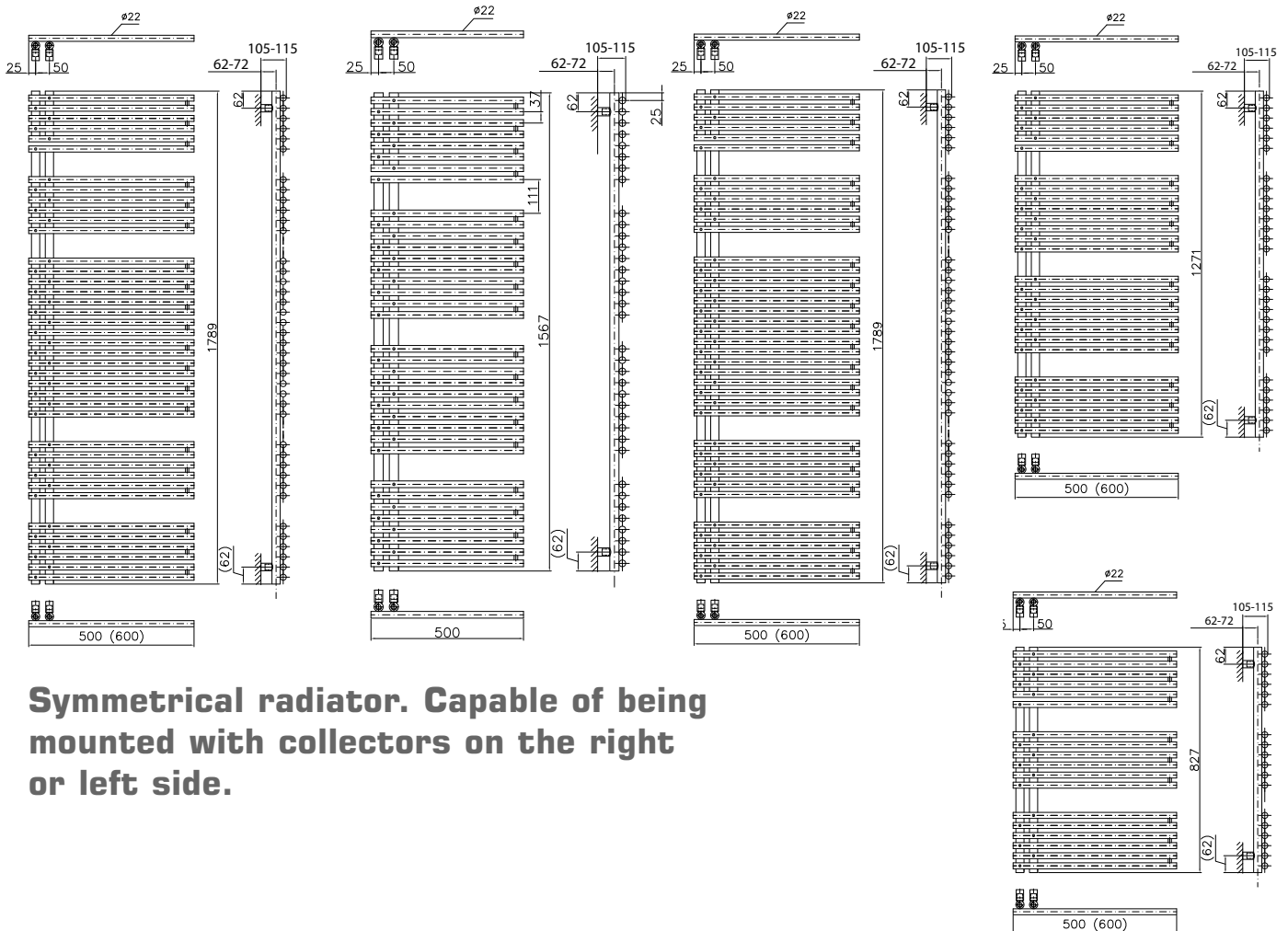

Symmetrical radiator. Capable of being mounted with collectors on the right or left side.

MODEL E



Oh this look!

Its design is both quite simple and smart. Placing such a radiator in a room is no compromise. Perfection in its construction guarantees a breathtaking product and satisfies the most demanding clients.



- › **Vertical pipes:** round Ø 30
- › **Horizontal pipes:** round Ø22
- › **Detail work:** radiator made from low-carbon steel with powder coated finish
- › **Standard colours:** white RAL 9003 or anthracite RAL 7016
- › **Mounting:** mounting kit included
- › **Further information:** non-standard size available to order



› **Types of connections:** page 184-185

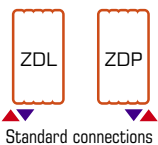

› **Recommended valves kits** details on pages 178-179

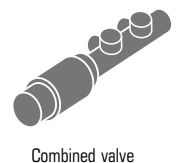
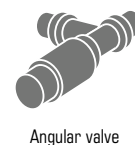

6+2
WARRANTY

2 additional years
of warranty
when purchasing
valves

info@luxrad.com

103

MODEL E COVERED



Height [mm]	Width [mm]	Collector Spacing [mm]	Depth [mm]	Space between wall and power slots [mm]	Radiator Weight [kg]	Radiator capacity [dm ³]	Power level [W] 55/45/20	power level [W] 75/65/20	Power level [W] 90/70/20
827	400	50	126-136	62-72	6.2	3.2	186	345	434
827	500	50	126-136	62-72	7.5	3.7	218	404	508
827	600	50	126-136	62-72	8.3	4.3	250	463	582
1271	400	50	126-136	62-72	9.4	4.9	277	514	646
1271	500	50	126-136	62-72	11	5.8	325	603	758
1271	600	50	126-136	62-72	12.7	6.7	372	690	868
1567	400	50	126-136	62-72	12	6.3	346	641	806
1567	500	50	126-136	62-72	14	7.4	406	752	946
1567	600	50	126-136	62-72	16	8.5	465	862	1084
1789	400	50	126-136	62-72	13.6	7	382	709	891
1789	500	50	126-136	62-72	16	8.2	448	831	1045
1789	600	50	126-136	62-72	18.4	9.5	514	952	1197

Dla szerokości do 500 mm możliwe wykonanie bez łączeń na końcach rurek poziomych

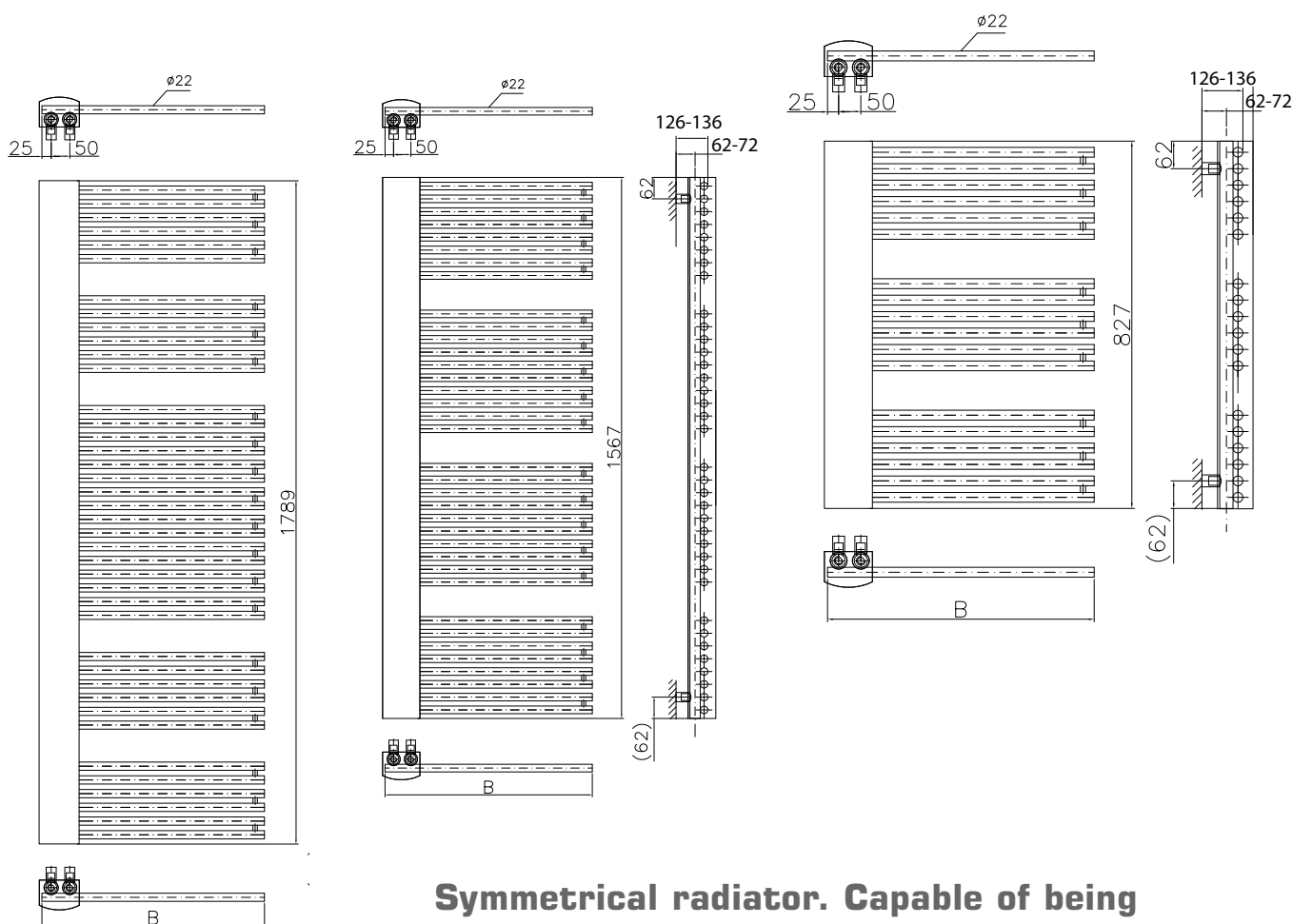

Symmetrical radiator. Capable of being mounted with collectors on the right or left side.

MODEL E COVERED



Beauty in a simple form

Extremely simple and yet interesting design of this radiator provides an interesting look, complemented by high quality materials and workmanship. The original finish will add a distinctive and unique character to every bathroom.



- › **Vertical pipes:** round Ø 30 with steel cover
- › **Horizontal straight pipes:** round Ø 22
- › **Detail work:** radiator made from low-carbon steel with powder coated finish
- › **Standard colours:** white RAL 9003 or anthracite RAL 7016
- › **Mounting:** mounting kit included
- › **Further information:** non-standard size available to order



› **Types of connections:** page 184-185

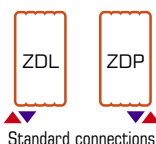

› **Recommended valves kits** details on pages 178-179



Axial valve



Straight valve



Angular valve



Combined valve

6+2
WARRANTY

2 additional years
of warranty
when purchasing
valves

info@luxrad.com

105

TYP E



Height [mm]	Width [mm]	Collector Spacing [mm]	Depth [mm]	Space between wall and power slots [mm]	Radiator Weight [kg]	Radiator capacity [dm ³]	Power level [W] 55/45/20	power level [W] 75/65/20	Power level [W] 90/70/20
883	500	50	103-113	62-72	6.2	3.8	210	390	490
1179	500	50	103-113	62-72	7.7	5.7	298	553	695

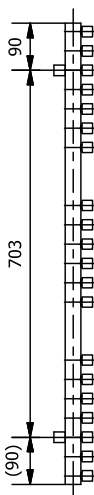
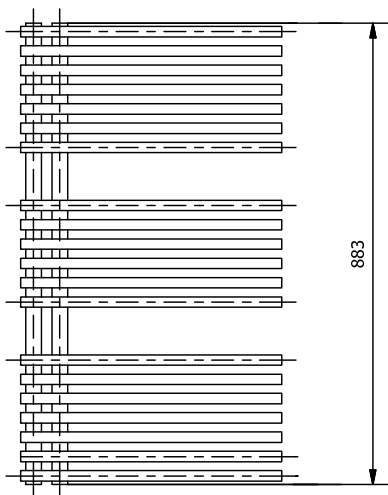
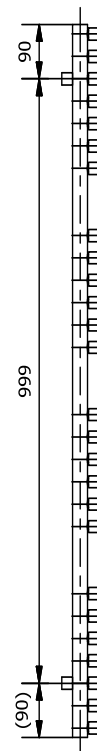
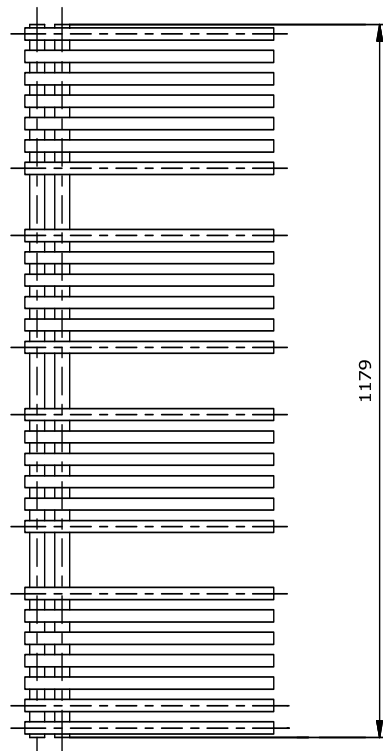
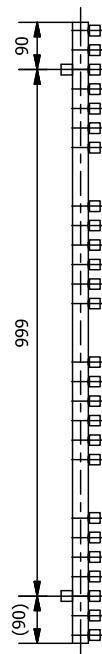
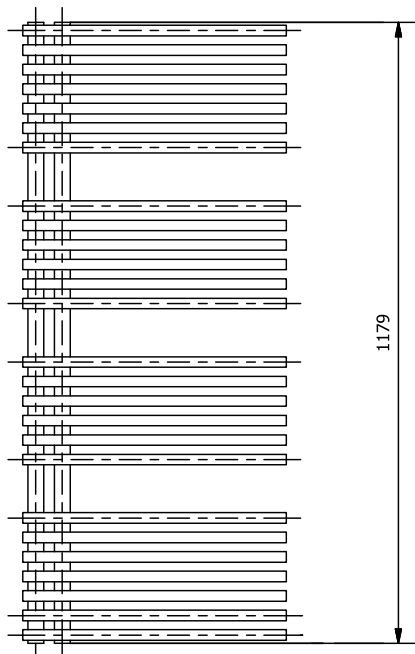
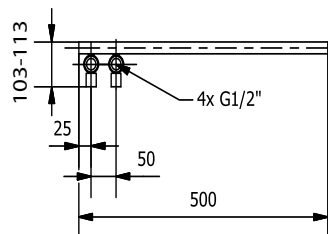
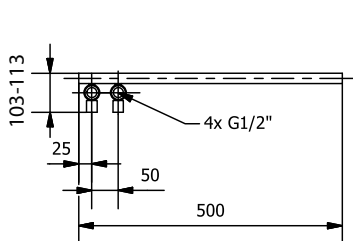

**Symmetrical radiator.
Capable of being
mounted with collectors
on the right or left side.**

TYP E



Perfect choice

This product is perfect for those who want to make a step forward and reject classic models. Geometrical shape of TYP E with square pipes will be a perfect solution for modern interiors. Horizontal pipes placed only on the one side give it a special innovative appearance.



- › **Vertical pipes:** round \varnothing 30
- › **Horizontal pipes:** square 20 x 20 mm
- › **Detail work:** radiator made from low-carbon steel with powder coated finish
- › **Standard colours:** white RAL 9003, structural graphite
- › **Mounting:** mounting kit included
- › **Further information:** non-standard size available to order



› **Types of connections:** page 184-185

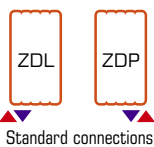

› **Recommended valves kits** details on pages 178-179



Axial valve



Straight valve



Angular valve

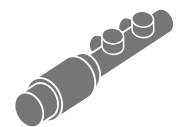

Combined valve

6+2
WARRANTY

2 additional years
of warranty
when purchasing
valves

info@luxrad.com

107

ELEGANT



Height [mm]	Width [mm]	Collector Spacing [mm]	Depth [mm]	Space between wall and power slots [mm]	Radiator Weight [kg]	Radiator capacity [dm ³]	Power level [W] 55/45/20	power level [W] 75/65/20	Power level [W] 90/70/20
760	500	50	82-92	66-76	8.3	2.4	159	295	371
1162	500	50	82-92	66-76	12.6	3.6	305	565	710

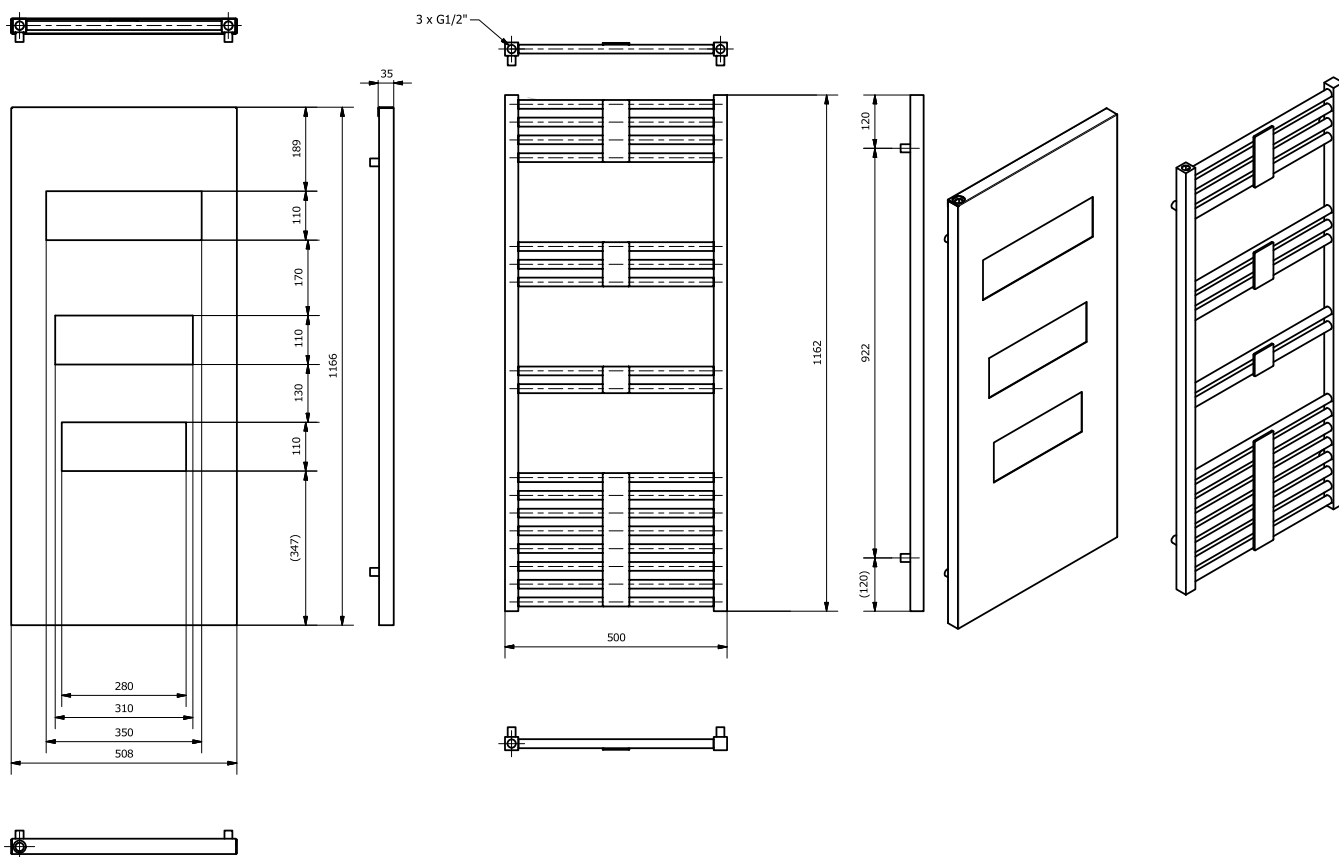

ELEGANT



Unconventional and Smart

ELEGANT unique design thanks to its simplicity, appears as classy and modern. Not only does its steel cover with rectangular holes play a decorative role but provides practical space to dry towels faster as well.



- › **Vertical pipes:** square 30 x 30 mm
- › **Horizontal pipes:** Ø 20 mm
- › **Cover:** 1,5 mm laser-curved, pasted steel
- › **Detail work:** radiator made from low-carbon steel with powder coated finish
- › **Standard colours:** white RAL 9003 or anthracite RAL 7016
- › **Mounting:** mounting kit included
- › **Further information:** non-standard size available to order



› **Types of connections:** page 184-185



Standard connections

› **Recommended valves kits** details on pages 178-179



Axial valve



Straight valve



Angular valve

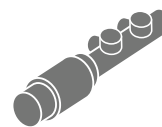

Combined valve

6+2
WARRANTY

2 additional years
of warranty
when purchasing
valves

info@luxrad.com

109

POLLUX



Height [mm]	Width [mm]	Collector Spacing [mm]	Depth [mm]	Space between wall and power slots [mm]	Radiator Weight [kg]	Radiator capacity [dm ³]	Power level [W] 55/45/20	power level [W] 75/65/20	Power level [W] 90/70/20
760	500	50	87-97	66-76	9.7	2.2	191	354	445
1100	500	50	87-97	66-76	14	3.4	277	513	645

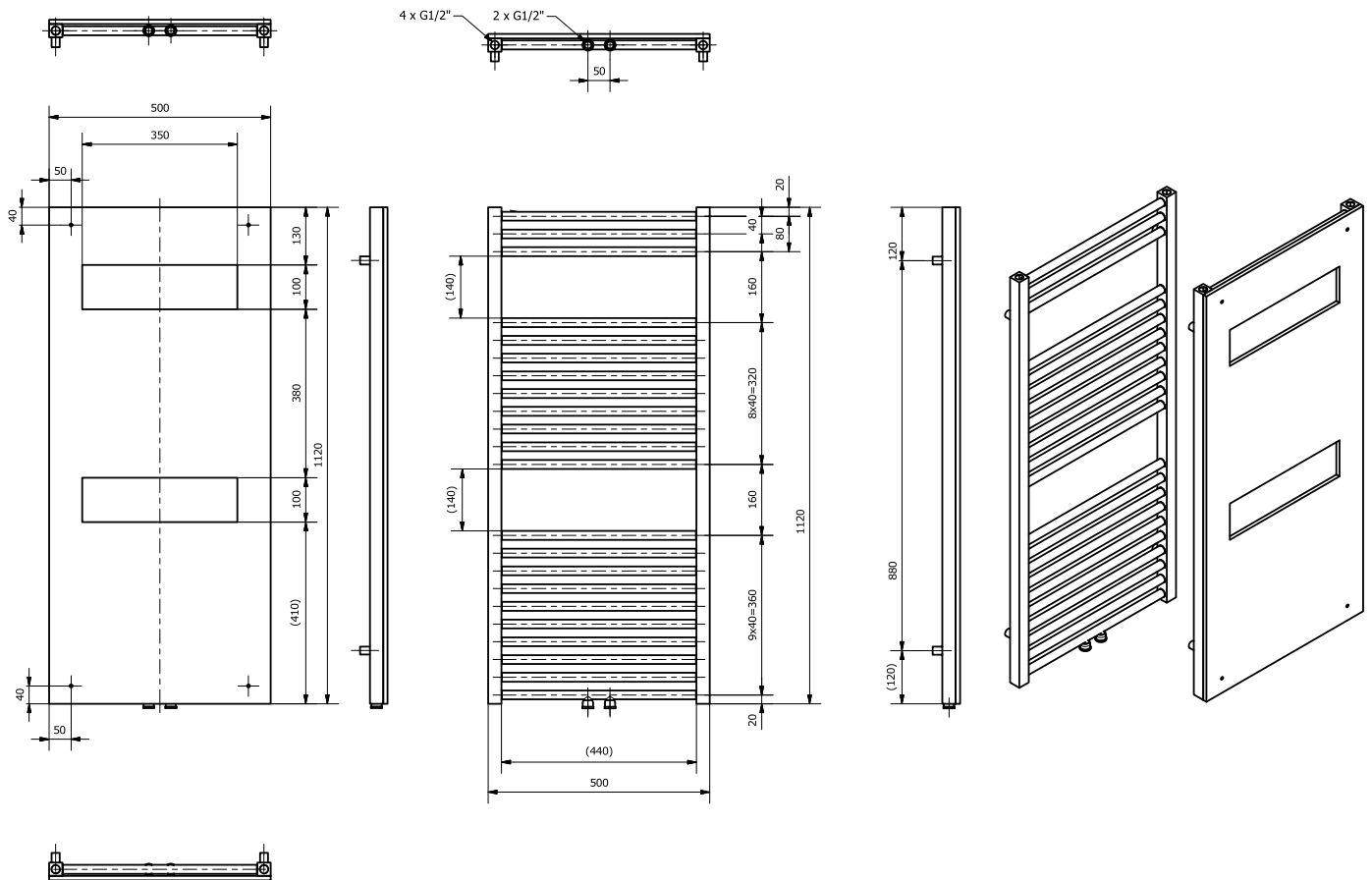

Optimal design

This design is based on a glass cover and rounded shapes. It is not only appealing but functional as well. Holes are made carefully – their edges are perfectly rounded. The front cover of the radiator is from solid tempered glass.



- › **Vertical pipes:** square 30 x 30 mm
- › **Horizontal pipes:** Ø 20 mm
- › **Cover:** 6 mm tempered glass pasted to the radiator
- › **Detail work:** radiator made from low-carbon steel with powder coated finish
- › **Standard colours:** black, white, red
- › **Mounting:** mounting kit included
- › **Further information:** electric heater assembly available to order



› **Types of connections:** page 184-185

› **Recommended valves kits** details on pages 178-179



Standard connections



Axial valve



Straight valve



Angular valve

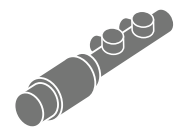

Combined valve

6+2
WARRANTY

2 additional years of warranty when purchasing valves

info@luxrad.com

1 1 1

GOCTA



Height [mm]	Width [mm]	Collector Spacing [mm]	Depth [mm]	Space between wall and power slots [mm]	Radiator Weight [kg]	Radiator capacity [dm ³]	Power level [W] 55/45/20	power level [W] 75/65/20	Power level [W] 90/70/20
720	500	450	81-91	46-56	7.7	4	264	489	615
720	600	550	81-91	46-56	8.2	4.3	301	559	703
1238	500	450	81-91	46-56	12.8	6.8	437	811	1020
1238	600	550	81-91	46-56	13.7	7.2	503	932	1172
1719	500	450	81-91	46-56	18.9	9.9	627	1162	1461
1719	600	550	81-91	46-56	20.3	10.7	721	1336	1680

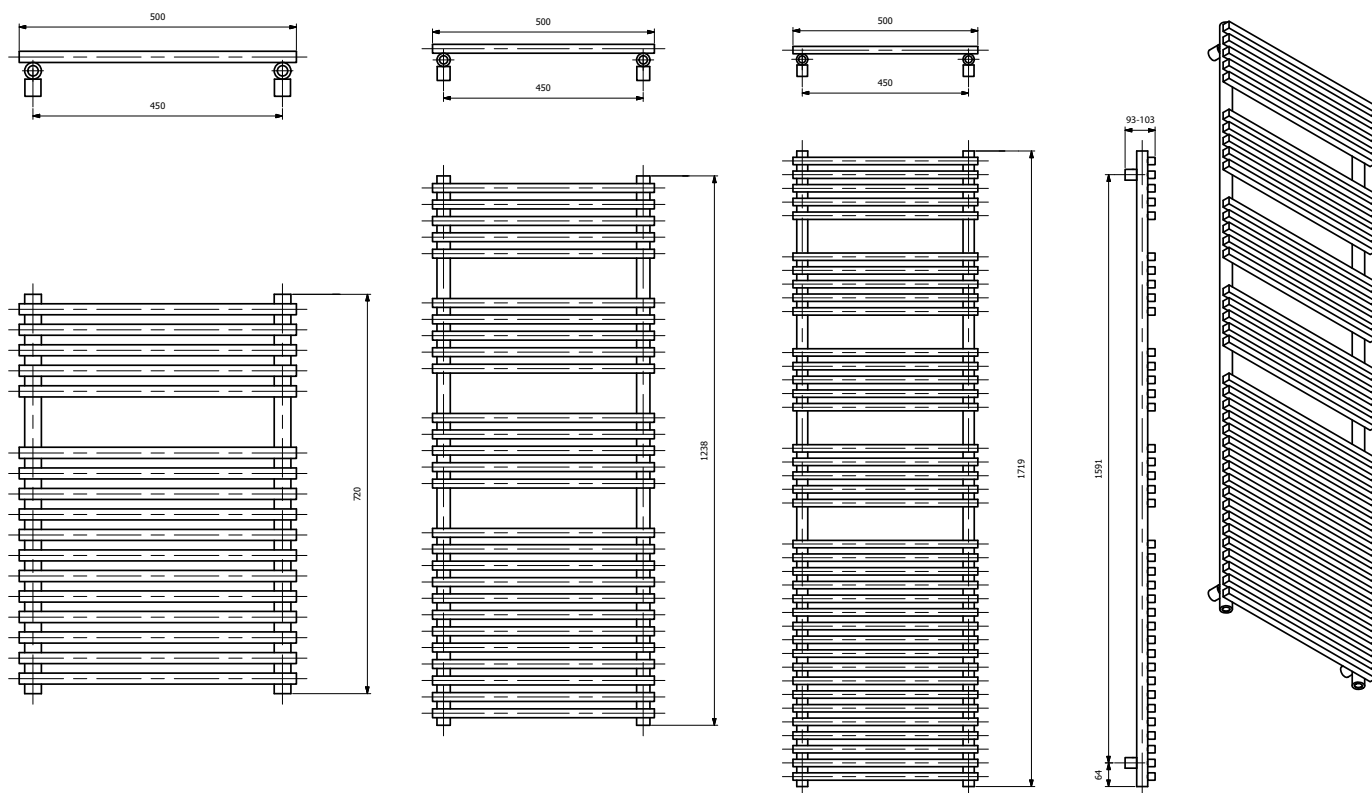

High rated one

Provides for plenty of space for hanging and drying towels due to the arrangement of special curvatures at 90 degree angles. This gives rise to a radiator with a modern and characteristic appearance. A satisfying solution for those who demand, wishing to combine modern design with practical solutions.



- › **Vertical pipes:** made on round profile Ø30
- › **Horizontal straight pipes:** square 20 x 20 mm
- › **Detail work:** radiator made from low-carbon steel with powder coated finish
- › **Standard colours:** white RAL 9003 or anthracite RAL 7016
- › **Mounting:** mounting kit included
- › **Further information:** non standard size, heater assembly or electric heater available to order



› **Types of connections:** page 184-185

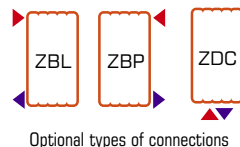
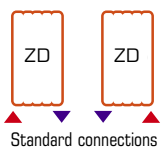

› **Recommended valves kits** details on pages 178-179

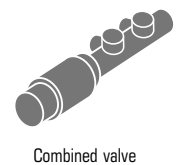

6+2
WARRANTY

2 additional years of warranty when purchasing valves

info@luxrad.com

113

PIKO



Height [mm]	Width [mm]	Collector Spacing [mm]	Depth [mm]	Space between wall and power slots [mm]	Radiator Weight [kg]	Radiator capacity [dm ³]	Power level [W] 55/45/20	power level [W] 75/65/20	Power level [W] 90/70/20
720	580	530	72-91	39-58	7.4	3.2	215	399	501
720	680	630	72-91	39-58	8.4	3.2	243	451	567
1238	580	530	72-91	39-58	11.5	5.2	332	616	774
1238	680	630	72-91	39-58	12.8	5.2	375	695	874
1719	580	530	72-91	39-58	16.4	7.2	453	839	1055
1719	680	630	72-91	39-58	18.5	8.5	511	948	1192

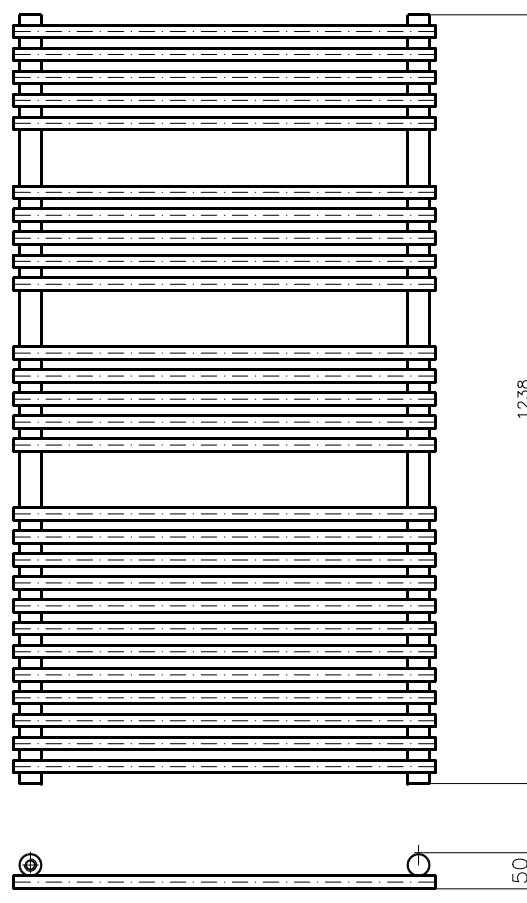
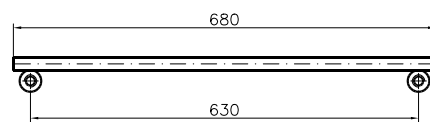
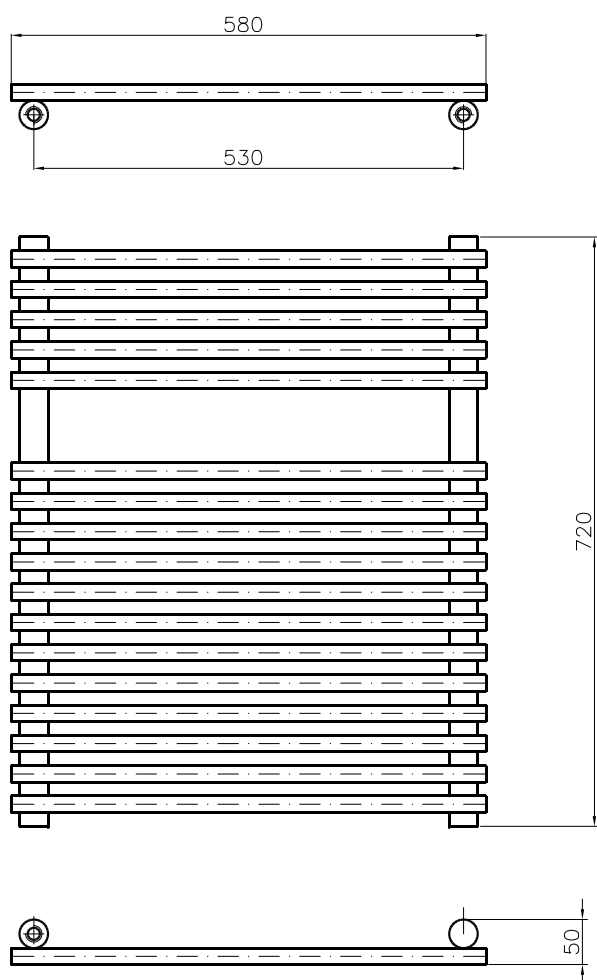

Fits everywhere

This is a popular representative of a classical form. Its clear design surpasses all temporary market trends in fashion and style meaning that PIKO is a good choice anytime and everywhere.



- › **Vertical pipes:** round Ø 30
- › **Horizontal pipes:** round Ø 20
- › **Detail work:** radiator made from low-carbon steel with powder coated finish
- › **Standard colours:** white RAL 9003 or anthracite RAL 7016
- › **Mounting:** mounting kit included
- › **Further information:** non standard size, heater assembly or electric heater available to order



› **Types of connections:** page 184-185

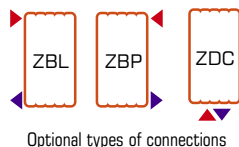
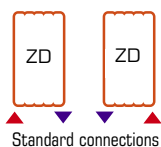

› **Recommended valves kits** details on pages 178-179

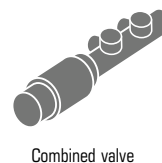

6+2
WARRANTY

2 additional years
of warranty
when purchasing
valves

info@luxrad.com

115

MERCURY



Height [mm]	Width [mm]	Collector Spacing [mm]	Depth [mm]	Space between wall and power slots [mm]	Radiator Weight [kg]	Radiator capacity [dm ³]	Power level [W] 55/45/20	power level [W] 75/65/20	Power level [W] 90/70/20
720	577	520	76-96	30-35	7.4	3.2	215	399	501
720	675	618	76-96	30-35	8.4	3.2	243	451	567
1238	577	520	76-96	30-35	11.5	5.2	332	616	774
1238	675	618	76-96	30-35	12.8	5.2	375	695	874
1719	577	520	76-96	30-35	16.4	7.2	453	839	1055
1719	675	618	76-96	30-35	18.5	8.5	511	948	1192

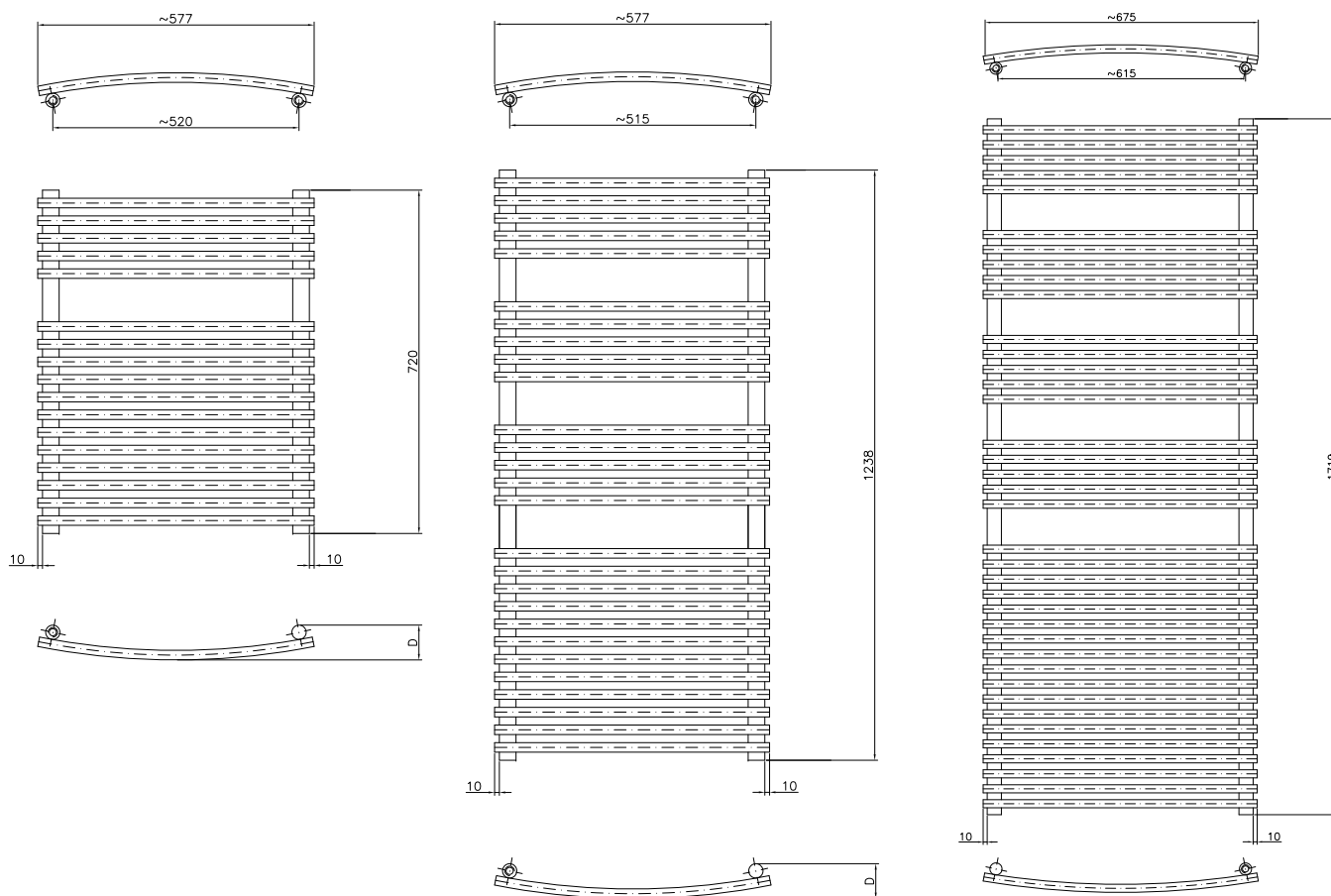

Specific family member

A member of the family, however pretty unique. Curved, round pipes give MERCURY a specific elegance and a discreet character. It also provides plenty of space for towels.



- **Vertical pipes:** round Ø 30
- **Horizontal bent pipes:** round Ø 20
- **Detail work:** radiator made from low-carbon steel with powder coated finish
- **Standard colours:** white RAL 9003 or anthracite RAL 7016
- **Mounting:** mounting kit included
- **Further information:** non standard size, heater assembly or electric heater available to order



➤ **Types of connections:** page 184-185

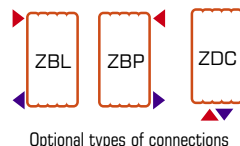
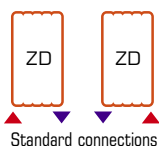

➤ **Recommended valves kits** details on pages 178-179

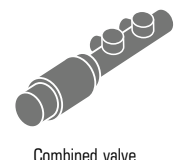

6+2
WARRANTY

2 additional years
of warranty
when purchasing
valves

info@luxrad.com

117

JUPITER



Height [mm]	Width [mm]	Collector Spacing [mm]	Depth [mm]	Space between wall and power slots [mm]	Radiator Weight [kg]	Radiator capacity [dm ³]	Power level [W] 55/45/20	power level [W] 75/65/20	Power level [W] 90/70/20
776	500	420	73-93	41-61	6.8	3.5	192	356	447
776	595	514	73-93	41-61	8	4.2	228	424	533
776	746	665	73-93	41-61	9.3	4.9	275	510	641
1154	500	420	73-93	41-61	9.8	5.1	276	512	644
1154	595	514	73-93	41-61	11.7	6.1	327	607	763
1154	746	665	73-93	41-61	13.6	7.2	393	729	917
1408	500	420	73-93	41-61	11.9	6.2	336	624	784
1408	595	514	73-93	41-61	14.3	7.4	400	741	932
1408	746	665	73-93	41-61	16.6	8.7	480	890	1119
1742	500	420	73-93	41-61	14.9	7.8	411	762	958
1742	595	514	73-93	41-61	17.8	9.3	489	907	1141
1742	746	665	73-93	41-61	20.6	10.9	588	1089	1369

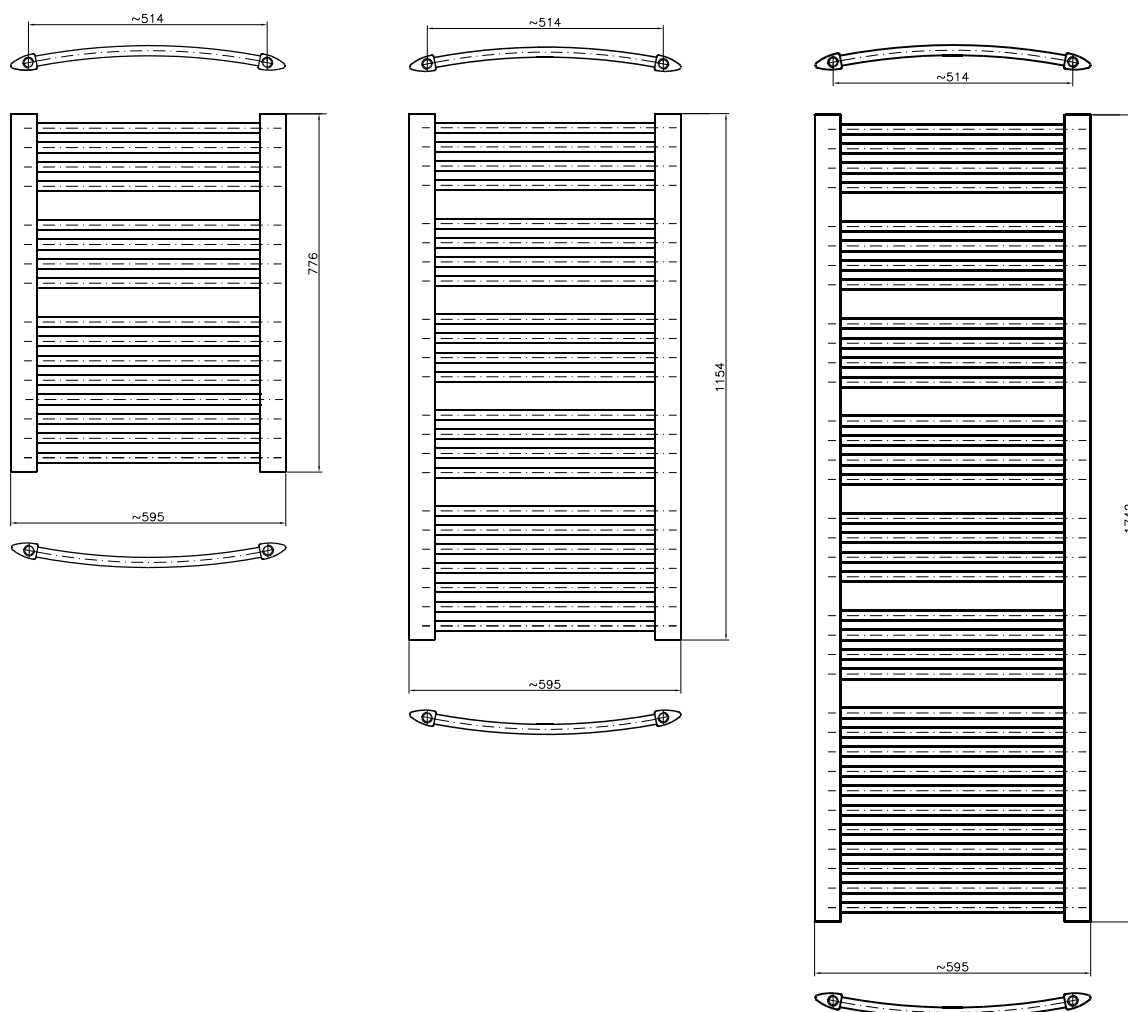

JUPITER



Sublime, harmonious, unique

Special trapezoidal profiles in combination with delicate curvatures give JUPITER an elegant, one of a kind, appearance. A selection of modern colours, such as "chrome effect" along with an optional middle mounted valve in a special housing provide for an exclusive bathroom arrangement.



- › **Vertical pipes:** triangular 34 x 56
- › **Horizontal bent pipes:** round Ø 22
- › **Detail work:** radiator made from low-carbon steel with powder coated finish
- › **Standard colours:** white RAL 9003 or anthracite RAL 7016
- › **Mounting:** mounting kit included
- › **Further information:** non standard size, heater assembly or electric heater available to order



› **Types of connections:** page 184-185

› **Recommended valves kits** details on pages 178-179

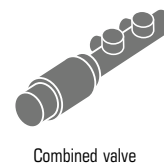
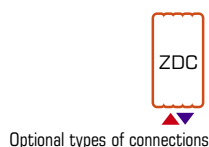
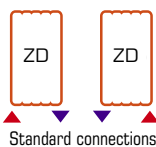

6+2
WARRANTY

2 additional years
of warranty
when purchasing
valves

info@luxrad.com

119

KASTOR



Height [mm]	Width [mm]	Collector Spacing [mm]	Depth [mm]	Space between wall and power slots [mm]	Radiator Weight [kg]	Radiator capacity [dm ³]	Power level [W] 55/45/20	power level [W] 75/65/20	Power level [W] 90/70/20
765	480	400	65-75	48-58	7.5	2.9	170	316	397
765	580	500	65-75	48-58	8	3.2	206	382	480
945	480	400	65-75	48-58	9	3.4	210	390	490
945	580	500	65-75	48-58	10.5	3.8	254	471	592
1215	480	400	65-75	48-58	11.5	4.5	270	501	630
1215	580	500	65-75	48-58	13.5	4.8	326	605	761
1395	480	400	65-75	48-58	14	5.3	310	575	723
1395	580	500	65-75	48-58	15.5	5.8	375	695	874
1620	480	400	65-75	48-58	16	6	360	668	840
1620	580	500	65-75	48-58	17.7	6.6	436	808	1016
1790	480	400	65-75	48-58	18	6.9	407	755	949
1790	580	500	65-75	48-58	19.9	7.6	492	912	1147

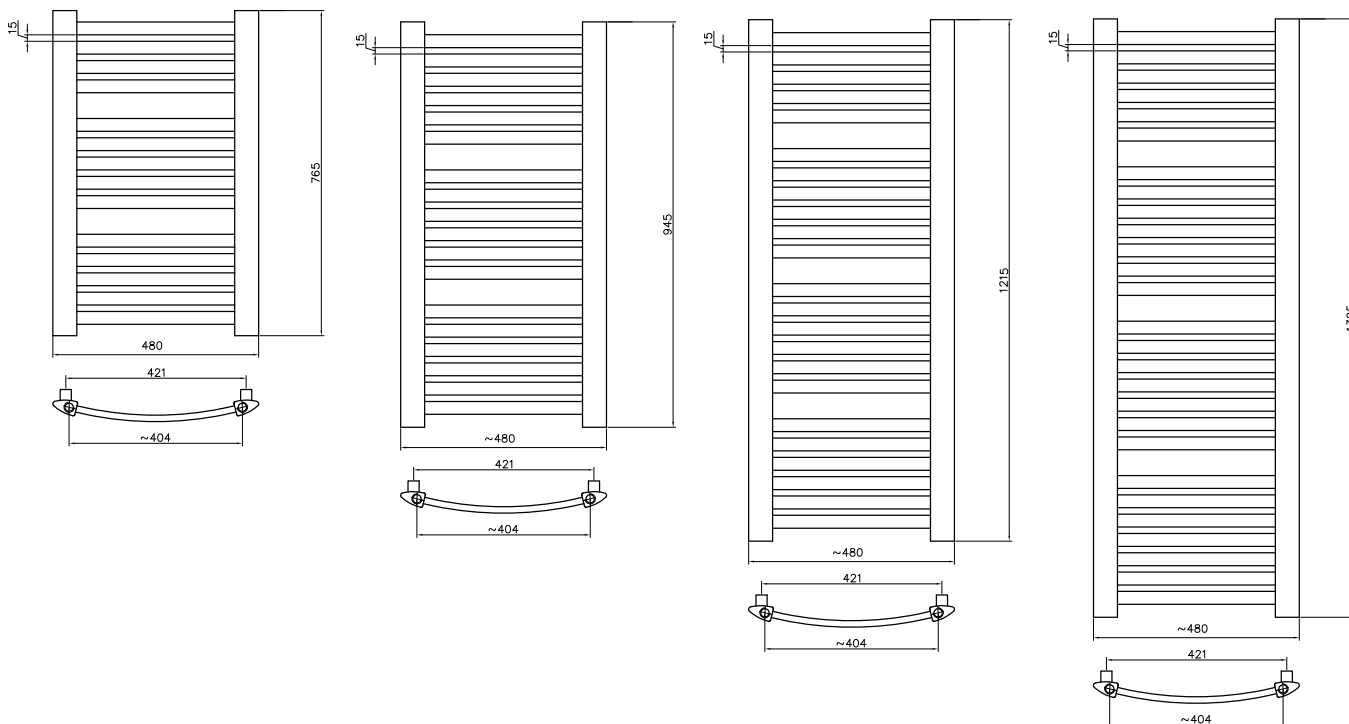

KASTOR



Triangles and squares

The combination of triangular and rectangular - flat tubes gives the impression of an exclusive interior element. This unique look of KASTOR radiator sets the style for any bathroom.

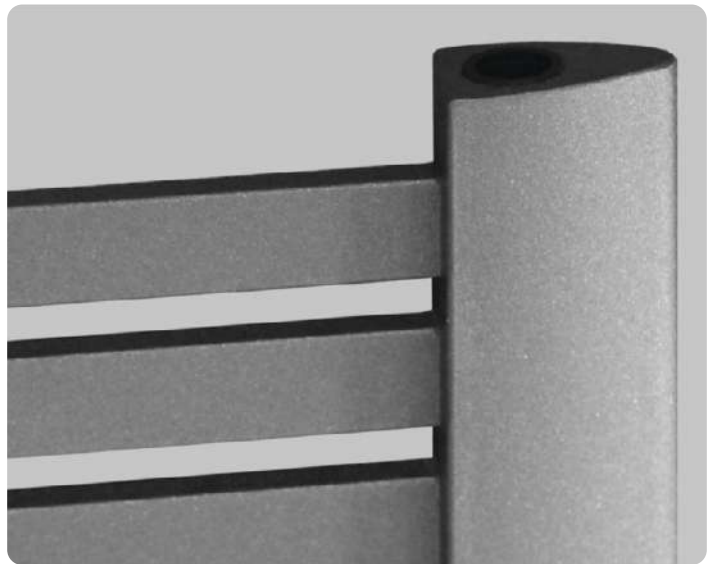

- › **Vertical pipes:** triangular 34 x 56
- › **Horizontal bent pipes:** rectangular 30 x 10
- › **Detail work:** radiator made from low-carbon steel with powder coated finish
- › **Standard colours:** white RAL 9003 or anthracite RAL 7016
- › **Mounting:** mounting kit included
- › **Further information:** valves covered, built-in thermostat



› **Types of connections:** page 184-185

› **Recommended valves kits** details on pages 178-179

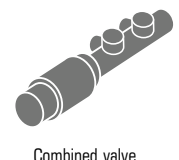
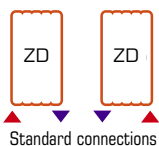

6+2
WARRANTY

2 additional years
of warranty
when purchasing
valves

info@luxrad.com

121

SALTO



Height [mm]	Width [mm]	Collector Spacing [mm]	Depth [mm]	Space between wall and power slots [mm]	Radiator Weight [kg]	Radiator capacity [dm ³]	Power level [W] 55/45/20	power level [W] 75/65/20	Power level [W] 90/70/20
462	432	382	141-151	46-56	4.1	2.2	120	224	281
462	532	482	141-151	46-56	4.5	2.4	137	254	319
666	432	382	141-151	46-56	5.4	2.8	194	360	452
666	532	482	141-151	46-56	6	3.1	221	411	517
666	632	582	141-151	46-56	6.7	3.4	249	462	581
904	432	382	141-151	46-56	7.2	3.7	252	467	587
904	532	482	141-151	46-56	8.1	4.1	289	536	674
904	632	582	141-151	46-56	9	4.5	324	601	756
1142	432	382	141-151	46-56	9	4.7	316	586	737
1142	532	482	141-151	46-56	10.1	5.2	360	668	840
1142	632	582	141-151	46-56	11.2	5.7	405	750	943
1380	432	382	141-151	46-56	10.9	5.6	390	724	910
1380	532	482	141-151	46-56	12.2	6.2	445	825	1037
1380	632	582	141-151	46-56	13.5	6.8	500	926	1164
1652	432	382	141-151	46-56	13	6.7	463	858	1079
1652	532	482	141-151	46-56	14.6	7.4	528	979	1231
1652	632	582	141-151	46-56	16.2	8.2	593	1099	1382
1788	432	382	141-151	46-56	14.6	7.6	525	973	1224
1788	532	482	141-151	46-56	16.6	8.4	600	1112	1398
1788	632	582	141-151	46-56	18.5	9.3	675	1251	1573

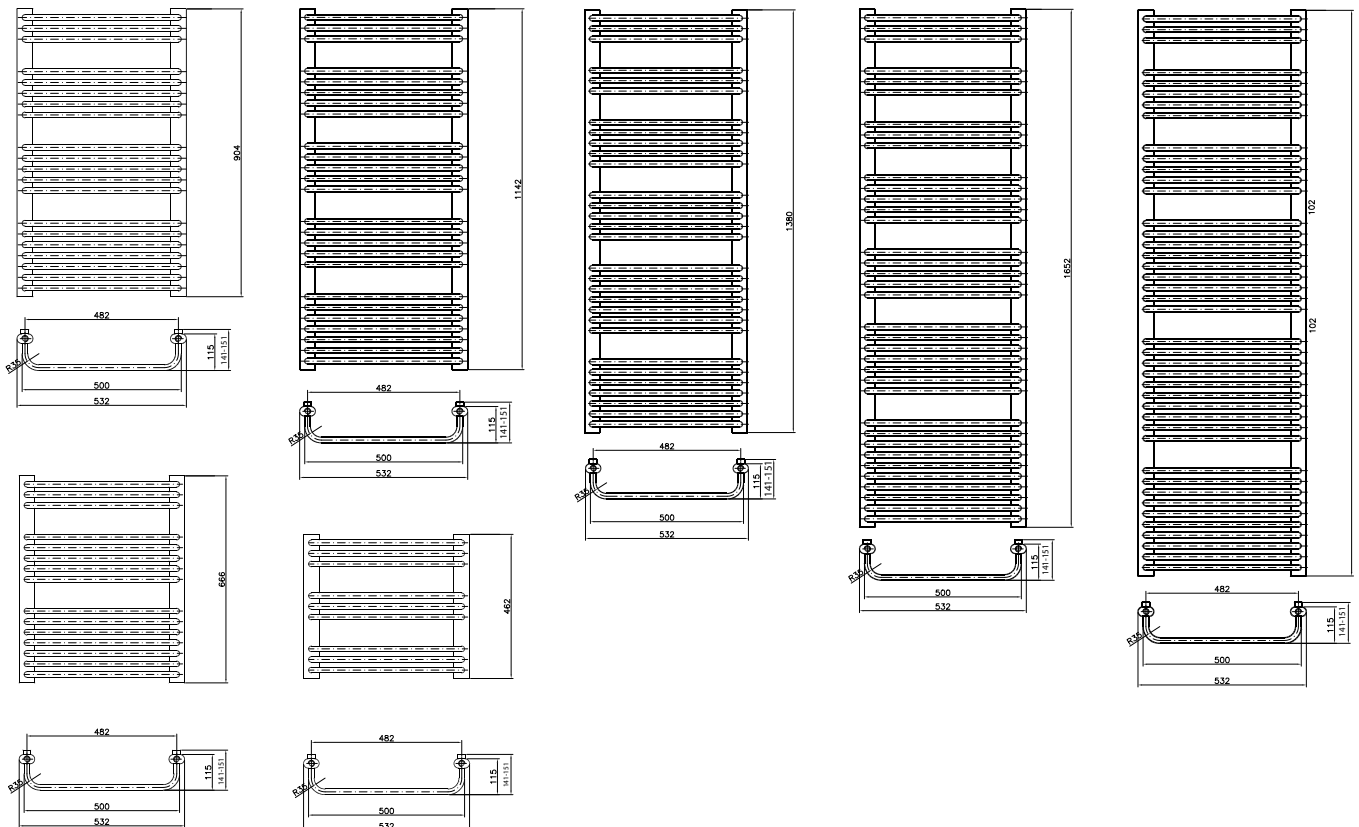

SALTO



Nicely curved

Plenty of space for hanging and drying towels, through the use of special curvatures at 90 degrees. A radiator of modern and unusual appearance. An appreciated solution for those with high demands for elegant design and practical solutions.



- › **Vertical pipes:** oval \varnothing 30 x 50
- › **Horizontal pipes:** round \varnothing 20
- › **Detail work:** radiator made from low-carbon steel with powder coated finish
- › **Standard colours:** white RAL 9003 or anthracite RAL 7016
- › **Mounting:** mounting kit included
- › **Further information:** non standard size, heater assembly or electric heater available to order



› **Types of connections:** page 184-185

› **Recommended valves kits** details on pages 178-179

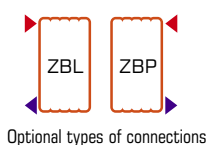
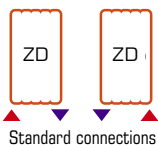

6+2
WARRANTY

2 additional years
of warranty
when purchasing
valves

info@luxrad.com

123

SALTO MAX



Height [mm]	Width [mm]	Collector Spacing [mm]	Depth [mm]	Space between wall and power slots [mm]	Radiator Weight [kg]	Radiator capacity [dm ³]	Power level [W] 55/45/20	power level [W] 75/65/20	Power level [W] 90/70/20
600	300	270/500	164-174	69-79	4.6	4.2	160	297	373
600	430	400/500	164-174	69-79	8.6	5	230	426	535
600	530	500/500	164-174	69-79	10.4	6.2	284	526	661
920	430	400/500	164-174	69-79	13.2	7.7	378	701	881
920	530	500/500	164-174	69-79	16.3	9.5	467	865	1088
1200	430	400/500	164-174	69-79	15.8	10	452	838	1054
1200	530	500/500	164-174	69-79	19.6	12.4	609	1128	1419
1400	430	400	164-174	69-79	18.4	11.6	527	977	1229
1400	530	500	164-174	69-79	22.8	14.4	656	1216	1529
1600	430	400	164-174	69-79	21	13.2	602	1116	1403
1600	530	500	164-174	69-79	26	16.5	750	1390	1748

Do wysokości 1200 mm grzejnik z uniwersalnym podłączeniem bocznym i dolnym

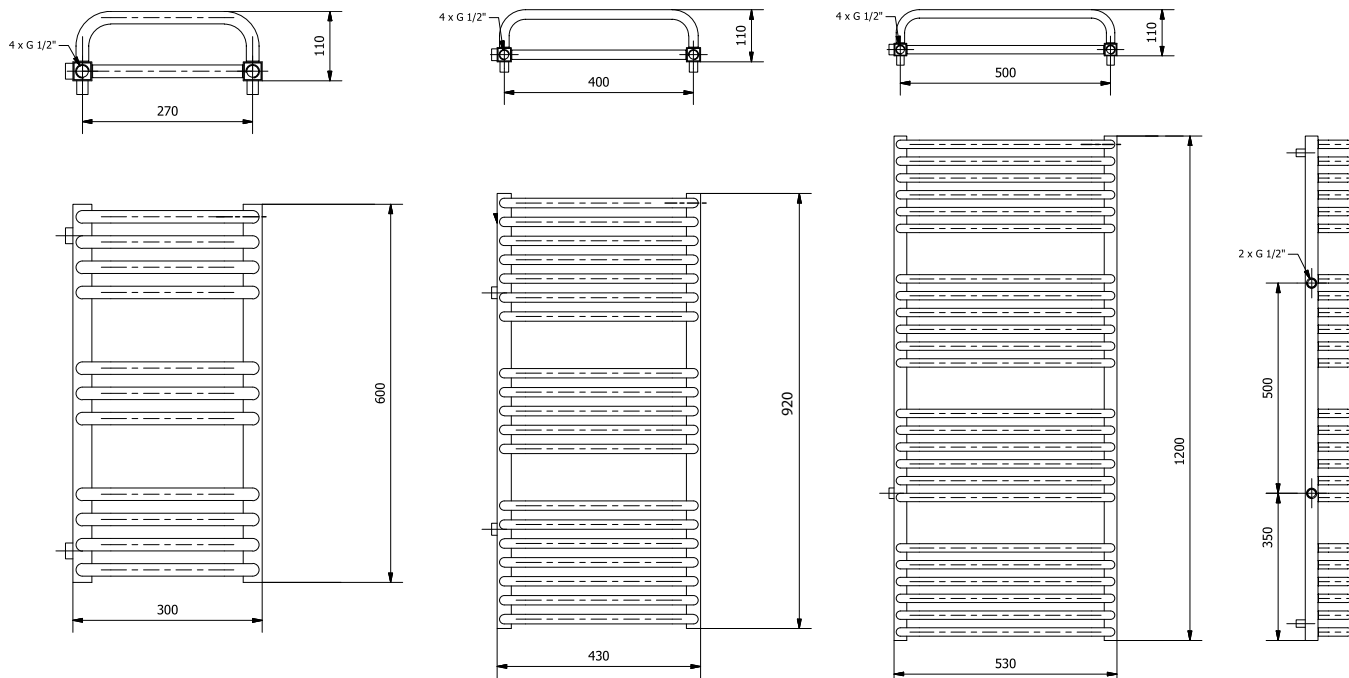

SALTO MAX



Let yourself be inspired

Salto Max is for people who value universal design solutions. The attractiveness of the radiator is emphasized by steel tubes of unprecedented form, which constitute a fashionable and stylish decoration. This model suits perfectly the bathroom decor with a modern as well as traditional character.



- › **Vertical pipes:** square 30 x 30 mm
- › **Horizontal pipes:** round Ø 20 in 2 rows
- › **Detail work:** radiator made from low-carbon steel with powder coated finish
- › **Standard colours:** white RAL 9003 or anthracite RAL 7016
- › **Mounting:** mounting kit included
- › **Further information:** non standard size, heater assembly or electric heater available to order



› **Types of connections:** page 184-185

› **Recommended valves kits** details on pages 178-179

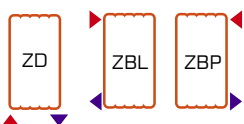

Standard connections



Optional types of connections



Axial valve



Straight valve



Angular valve



Combined valve

6+2
WARRANTY

2 additional years
of warranty
when purchasing
valves

info@luxrad.com

125

SALTO I



Height [mm]	Width [mm]	Collector Spacing [mm]	Depth [mm]	Space between wall and power slots [mm]	Radiator Weight [kg]	Radiator capacity [dm ³]	Power level [W] 55/45/20	power level [W] 75/65/20	Power level [W] 90/70/20
600	430	400	141-151	46-56	5.5	4.1	145	269	338
600	530	500	141-151	46-56	6	4.5	188	349	439
920	430	400	141-151	46-56	7.4	5.2	222	412	518
920	530	500	141-151	46-56	8	5.7	289	536	674
1200	430	400	141-151	46-56	10.5	6.2	290	538	676
1200	530	500	141-151	46-56	11.2	6.8	377	699	879

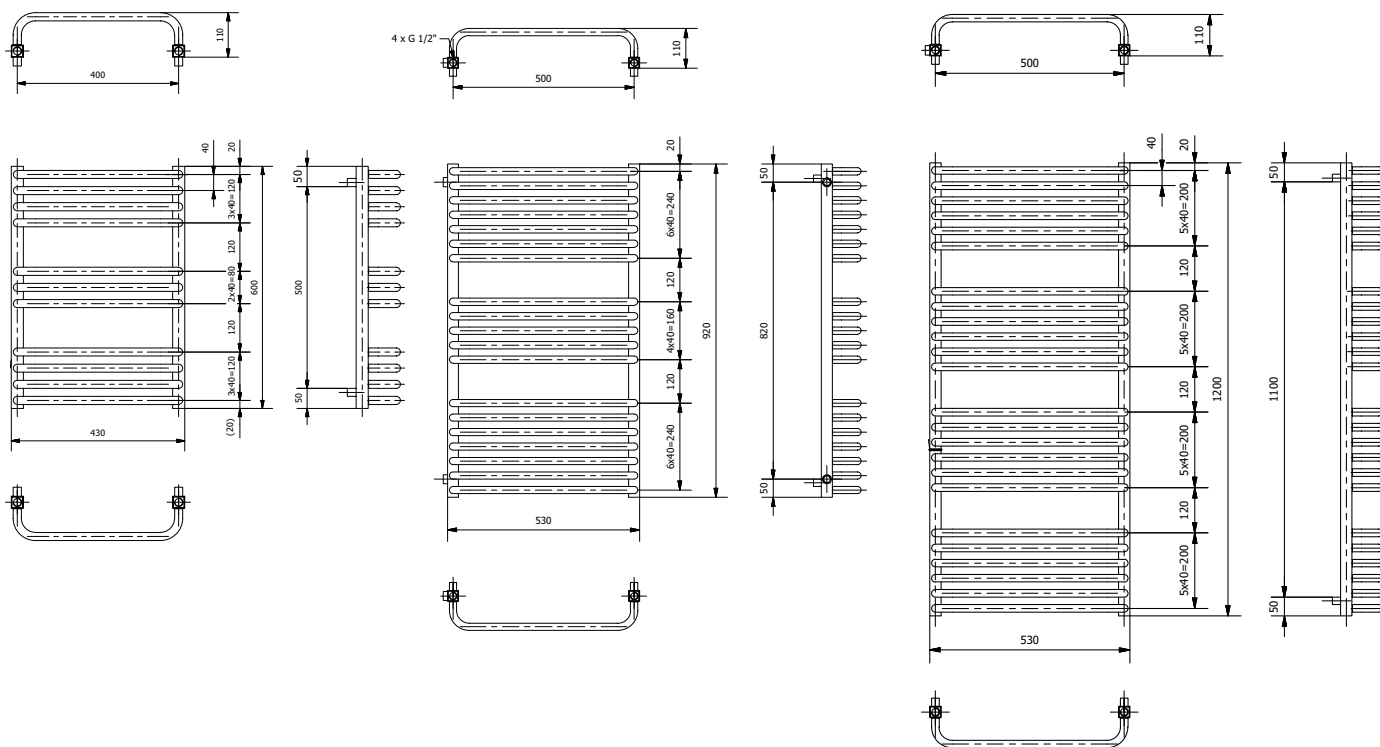

SALTO I



Radiator without secrets

The curved line of this radiator follows new trends in world design, taking care of unique finishing elements. The base of the construction is solid steel tubes with an exceptionally shiny surface. Products from the SALTO line perfectly suit the interiors in a minimalist and modern style.



- › **Vertical pipes:** square 30 x 30 mm
- › **Horizontal pipes:** round Ø 20
- › **Detail work:** radiator made from low-carbon steel with powder coated finish
- › **Standard colours:** white RAL 9003 or anthracite RAL 7016
- › **Mounting:** mounting kit included
- › **Further information:** Heater assembly or electric heater available to order



RAL colour system and special colours available



Warranty



Maximum temperature



Maximum work pressure



Electric version available



Hydro-electric version available



Additional hangers

› **Types of connections:** page 184-185

› **Recommended valves kits** details on pages 178-179



Standard connections

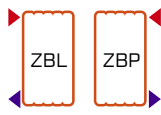

Optional types of connections



Axial valve



Straight valve



Angular valve

6+2
WARRANTY

2 additional years
of warranty
when purchasing
valves

info@luxrad.com

127

OVALTIC



Height [mm]	Width [mm]	Collector Spacing [mm]	Depth [mm]	Space between wall and power slots [mm]	Radiator Weight [kg]	Radiator capacity [dm ³]	Power level [W] 55/45/20	power level [W] 75/65/20	Power level [W] 90/70/20
462	500	190	143-153	46-56	6.3	2.1	172	319	401
462	600	190	143-153	46-56	7.5	2.4	205	380	478
768	500	190	143-153	46-56	10.7	3.7	285	529	665
768	600	190	143-153	46-56	12.8	4.2	341	632	795
1006	500	190	143-153	46-56	13.8	4.8	363	673	846
1006	600	190	143-153	46-56	16.6	5.5	434	805	1012
1176	500	190	143-153	46-56	18.7	6.3	491	910	1144
1176	600	190	143-153	46-56	22.3	7.5	590	1094	1376
1720	500	190	143-153	46-56	27.3	6.2	687	1274	1602
1720	600	190	143-153	46-56	32.7	10.9	827	1533	1928

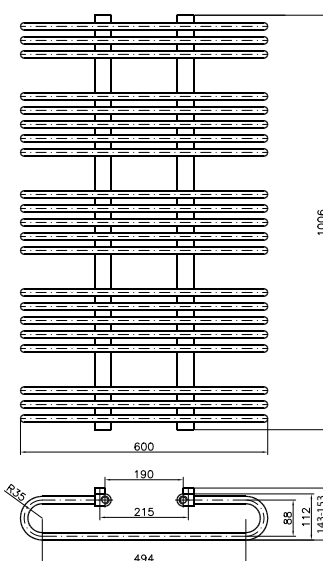
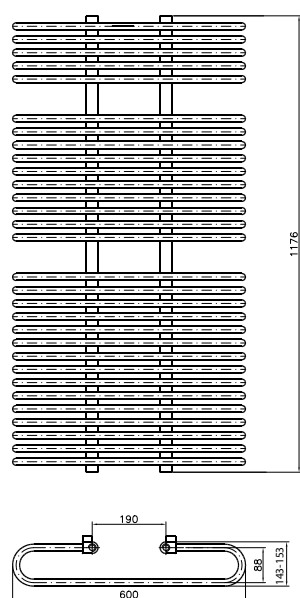
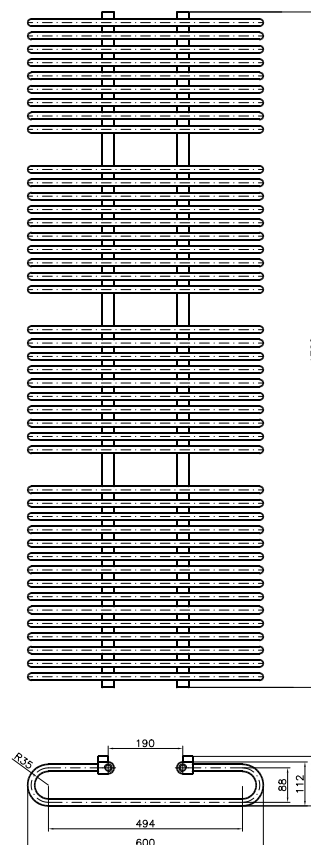
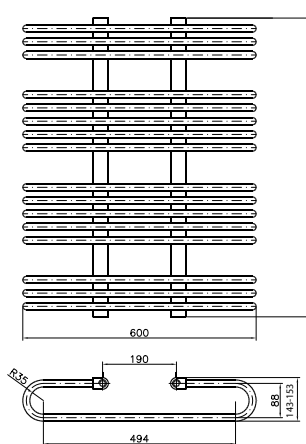
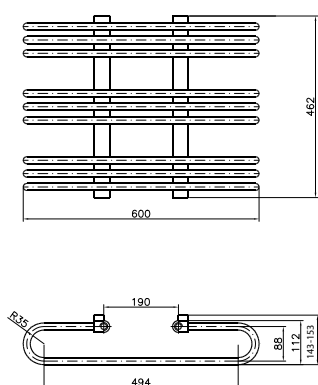

Independent individualist

The appearance and efficiency of OVALTIC speak for themselves. Styling, which arose from rounded pipes formed at 180 degrees, provides for a very attractive appearance. OVALTIC gathers attention wherever it is placed. A high level of efficiency makes for a universal radiator which can be used anywhere in the home.



- › **Vertical pipes:** made on profile D 40 x 30
- › **Horizontal pipes:** round Ø 18
- › **Detail work:** radiator made from low-carbon steel with powder coated finish
- › **Standard colours:** white RAL 9003 or anthracite RAL 7016
- › **Mounting:** mounting kit included
- › **Further information:** non standard size, heater assembly or electric heater available to order



› **Types of connections:** page 184-185

› **Recommended valves kits** details on pages 178-179



Standard connection



Axial valve



Straight valve



Angular valve

6+2
WARRANTY

2 additional years
of warranty
when purchasing
valves

info@luxrad.com

129

OVALTIC COVER



Height [mm]	Width [mm]	Collector Spacing [mm]	Depth [mm]	Space between wall and power slots [mm]	Radiator Weight [kg]	Radiator capacity [dm ³]	Power level [W] 55/45/20	power level [W] 75/65/20	Power level [W] 90/70/20
768	500	50	160-179	63-82	10.7	3.7	285	529	665
768	600	50	160-179	63-82	12.8	4.2	341	632	795
1006	500	50	160-179	63-82	13.8	4.8	363	673	846
1006	600	50	160-179	63-82	16.6	5.5	434	805	1012
1176	500	50	160-179	63-82	18.7	6.3	491	910	1144
1176	600	50	160-179	63-82	22.3	7.5	590	1094	1376

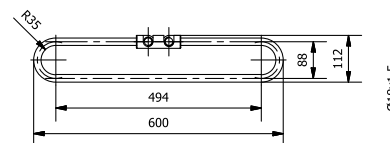
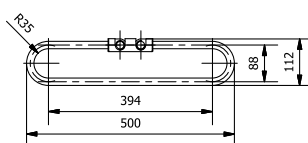
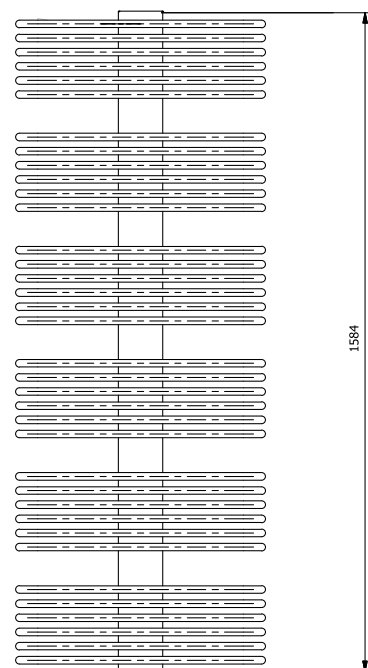
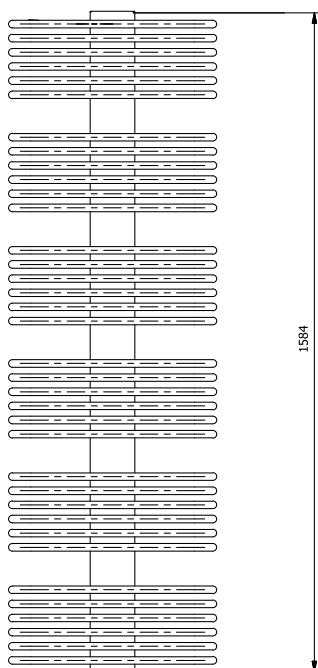
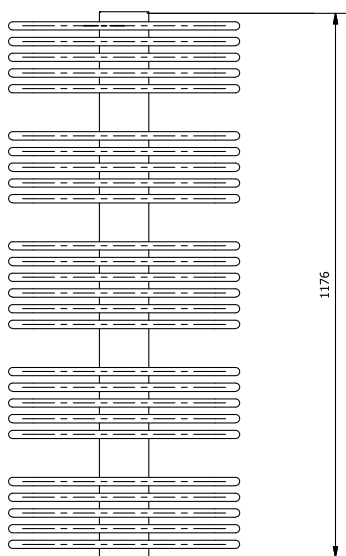
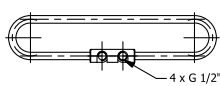
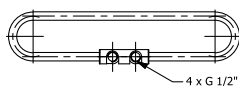

OVALTIC COVER



Modern project

This product is ideal for people who value a timeless design. The radiator looks light and subtle, making the bathroom a sophisticated and modern bathing room.

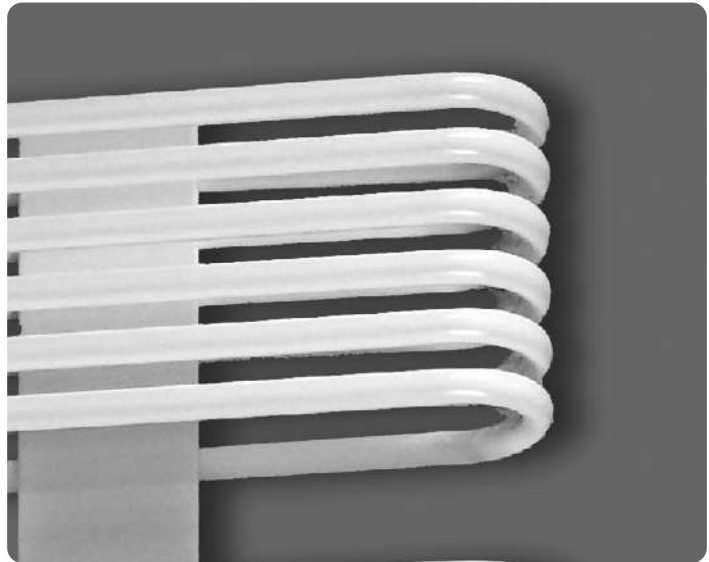

- › **Vertical pipes:** made on profile D 40 x 30 with steel cover
- › **Horizontal pipes:** round Ø 18
- › **Detail work:** radiator made from low-carbon steel with powder coated finish
- › **Standard colours:** white RAL 9003 or anthracite RAL 7016
- › **Mounting:** mounting kit included
- › **Further information:** non standard size, heater assembly or electric heater available to order



› **Types of connections:** page 184-185

› **Recommended valves kits** details on pages 178-179



Standard connections



Axial valve



Straight valve



Angular valve

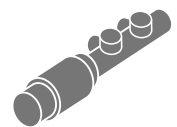

Combined valve

6+2
WARRANTY

2 additional years
of warranty
when purchasing
valves

info@luxrad.com

131

KILE



Height [mm]	Width [mm]	Collector Spacing [mm]	Depth [mm]	Space between wall and power slots [mm]	Radiator Weight [kg]	Radiator capacity [dm ³]	Power level [W] 55/45/20	power level [W] 75/65/20	Power level [W] 90/70/20
764	500	470	222-241	62-81	6.6	3.4	205	381	479
764	600	570	222-241	62-81	7.4	3.8	239	443	557
764	700	670	222-241	62-81	8.2	4.2	273	506	636
1172	500	470	222-241	62-81	10.6	5.2	302	560	704
1172	600	570	222-241	62-81	12.1	5.9	351	651	818
1172	700	670	222-241	62-81	13.6	6.5	399	740	930
1691	500	470	222-241	62-81	13.8	7.3	438	812	1021
1691	600	570	222-241	62-81	15.6	8.2	509	943	1186
1691	700	670	222-241	62-81	17.5	9.2	579	1074	1351

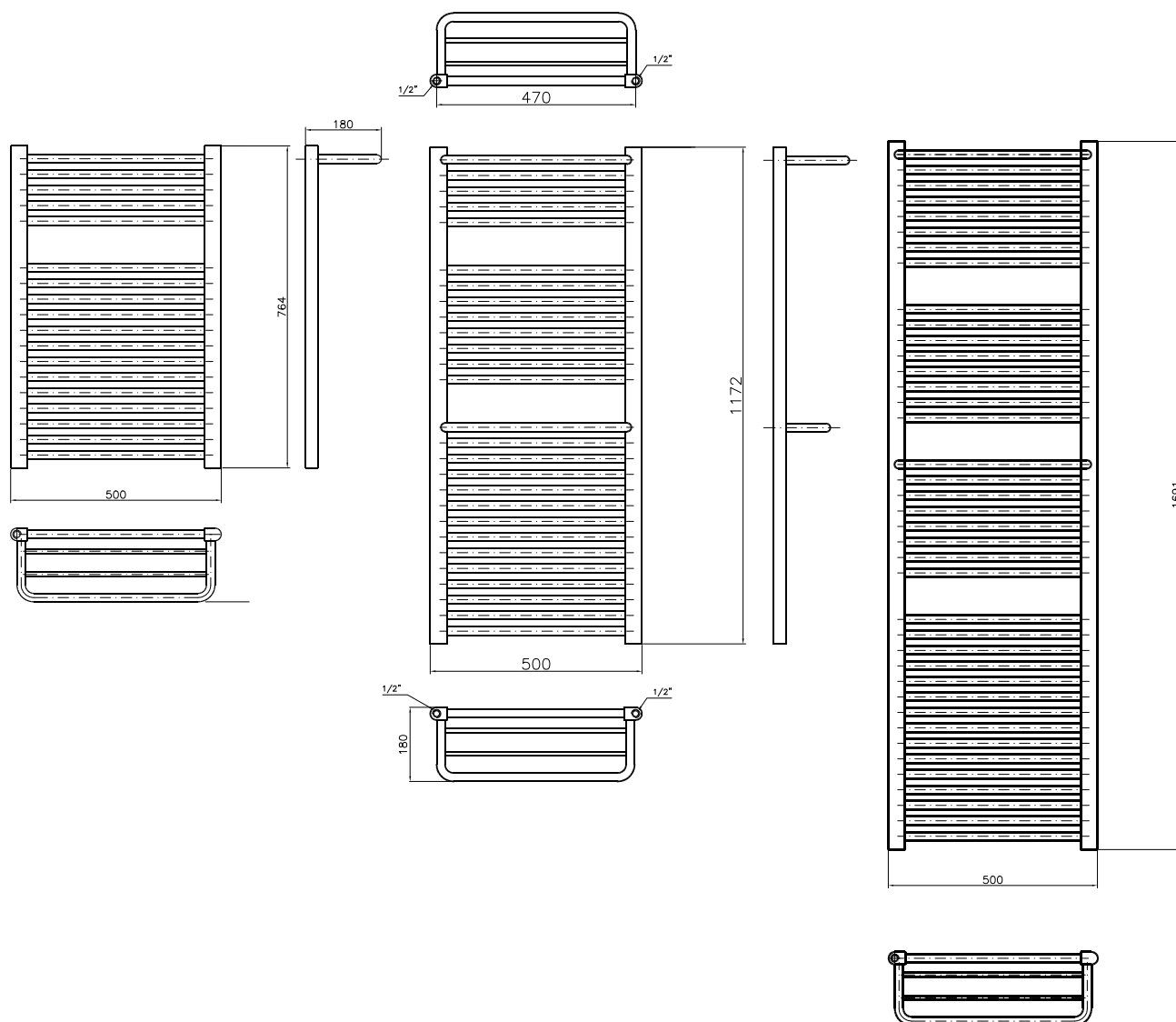

Classic edition with shelves

Plenty of space for drying and hanging towels, thanks to the incorporation of special shelves. This also provides a very individual appearance.



- › **Vertical pipes:** made on profile D 40 x 30
- › **Horizontal pipes:** round Ø 20
- › **Detail work:** radiator made from low-carbon steel with powder coated finish
- › **Standard colours:** white RAL 9003 or anthracite RAL 7016
- › **Mounting:** mounting kit included
- › **Further information:** non standard size, heater assembly or electric heater available to order, built-in heating shelves



› **Types of connections:** page 184-185

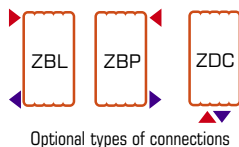
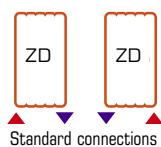

› **Recommended valves kits** details on pages 178-179

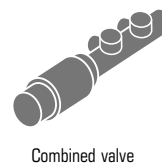

6+2
WARRANTY
2 additional years of warranty when purchasing valves

info@luxrad.com

133

MARS



Height [mm]	Width [mm]	Collector Spacing [mm]	Depth [mm]	Space between wall and power slots [mm]	Radiator Weight [kg]	Radiator capacity [dm ³]	Power level [W] 55/45/20	power level [W] 75/65/20	Power level [W] 90/70/20
774	500	470	86-106	61-81	7.7	5.2	369	685	861
774	600	570	86-106	61-81	9.3	6.2	443	822	1034
1026	500	470	86-106	61-81	10.2	6.7	493	913	1148
1026	600	570	86-106	61-81	12.2	7.9	591	1095	1377
1404	500	470	86-106	61-81	13.9	9.1	602	1115	1402
1404	600	570	86-106	61-81	16.7	10.9	657	1218	1532
1698	600	570	86-106	61-81	20	13.2	788	1461	1837

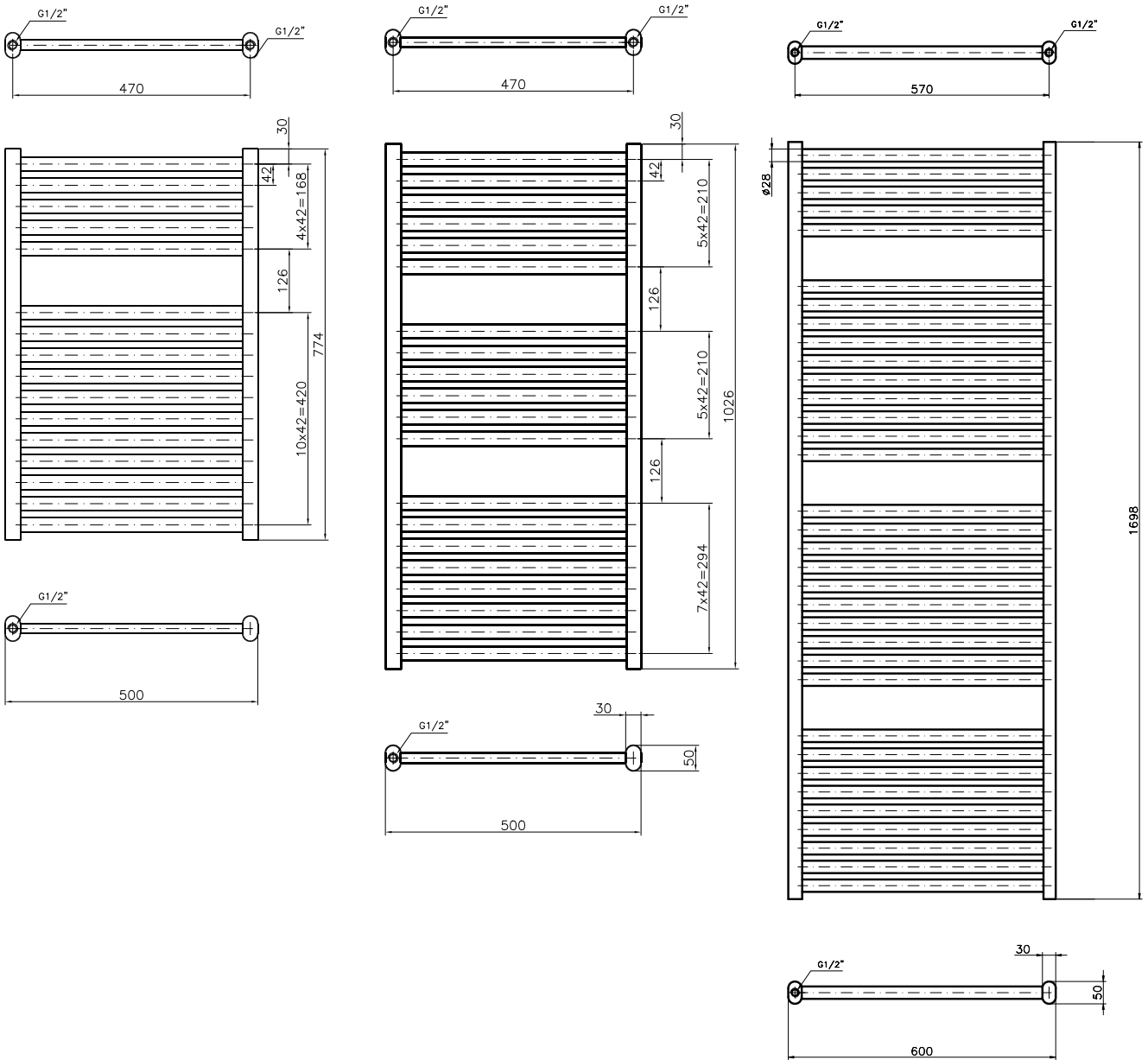

MARS



Tough one

MARS is a perfect solution when a distinctive piece of equipment and high heating efficiency are expected. The most noticeable features of Mars are collecting pipes and transverse tubes. The model shows its utility in large bathrooms and spacious rooms as well as in the vestibules and corridors.



- › **Vertical pipes:** made on profile 2 x D
- › **Horizontal straight pipes:** round \varnothing 28
- › **Detail work:** radiator made from low-carbon steel with powder coated finish
- › **Standard colours:** white RAL 9003 or anthracite RAL 7016
- › **Mounting:** mounting kit included
- › **Further information:** non standard size, heater assembly or electric heater available to order



› **Types of connections:** page 184-185

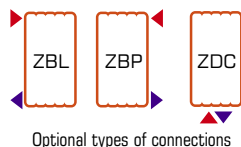
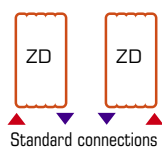

› **Recommended valves kits** details on pages 178-179

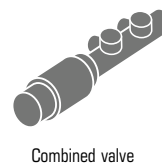

6+2
WARRANTY

2 additional years
of warranty
when purchasing
valves

info@luxrad.com

135

KWADRO



Height [mm]	Width [mm]	Collector Spacing [mm]	Depth [mm]	Space between wall and power slots [mm]	Radiator Weight [kg]	Radiator capacity [dm ³]	Power level [W] 55/45/20	power level [W] 75/65/20	Power level [W] 90/70/20
720	500	470	61-71	46-56	6.1	3.2	210	389	489
720	600	570	61-71	46-56	7.3	3.8	252	467	587
1120	500	470	61-71	46-56	9.3	4.8	312	578	727
1120	600	570	61-71	46-56	11.1	5.8	374	694	873
1720	500	570	61-71	46-56	14.3	7.5	472	875	1100
1720	600	570	61-71	46-56	17.1	9	567	1050	1320

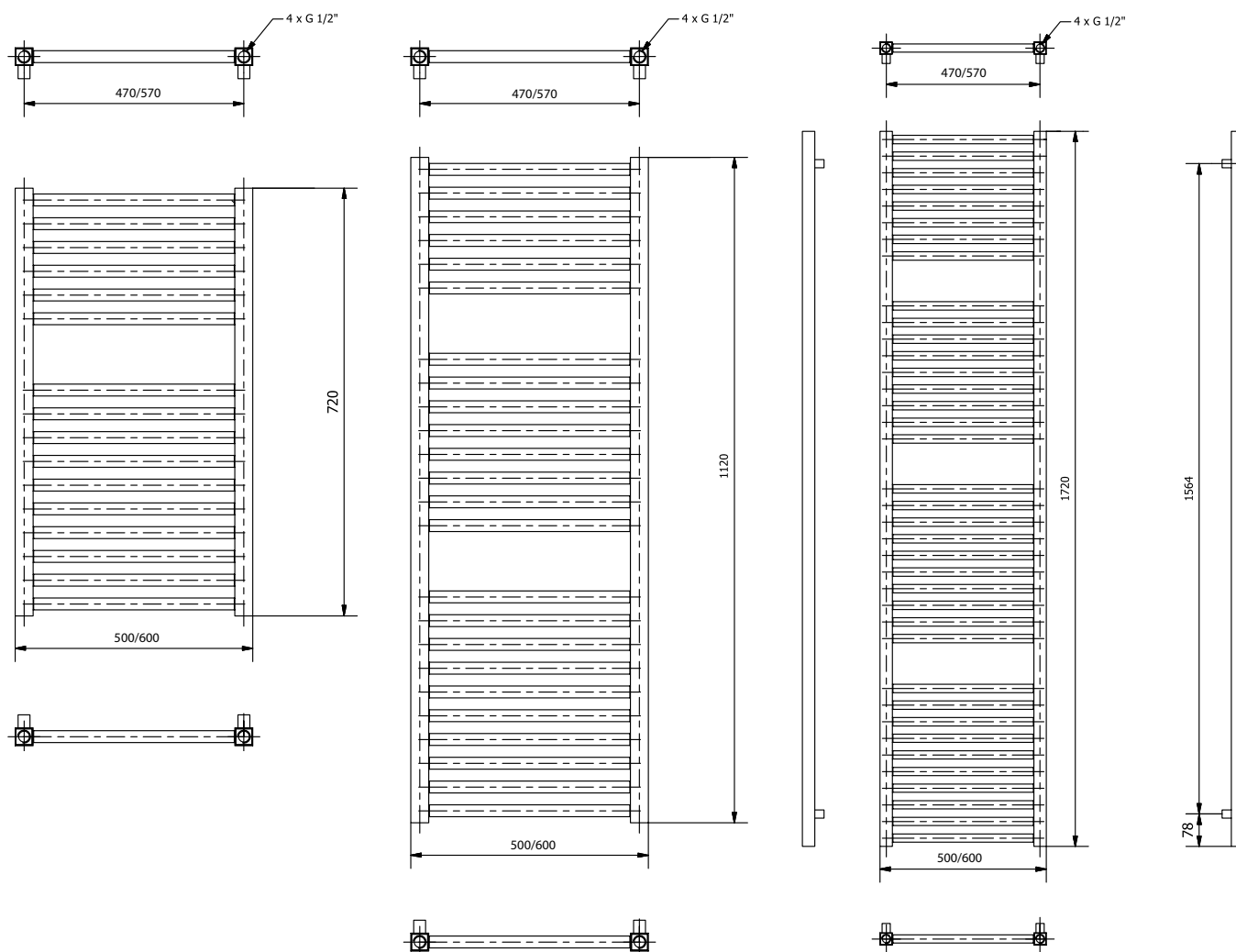

Square power

An ideal radiator must function and create a pleasant atmosphere without interference. What is more is the fact that sleek and appealing KWADRO, provides every room with a rich form and individual character:



- › **Vertical pipes:** made on square profile 30 x 30
- › **Horizontal pipes:** square 20 x 20
- › **Detail work:** radiator made from low-carbon steel with powder coated finish
- › **Standard colours:** white RAL 9003 or anthracite RAL 7016
- › **Mounting:** mounting kit included
- › **Further information:** non standard size, heater assembly or electric heater available to order



› **Types of connections:** page 184-185

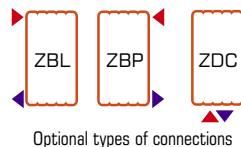
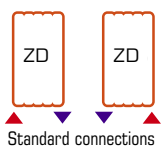

› **Recommended valves kits** details on pages 178-179

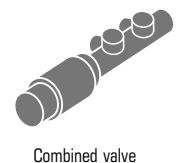
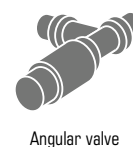

6+2
WARRANTY

2 additional years of warranty when purchasing valves

info@luxrad.com

137

ELIPSO



Height [mm]	Width [mm]	Collector Spacing [mm]	Depth [mm]	Space between wall and power slots [mm]	Radiator Weight [kg]	Radiator capacity [dm ³]	Power level [W] 55/45/20	power level [W] 75/65/20	Power level [W] 90/70/20
790	250	220	78	25	4.3	2.1	121	225	283
1086	250	220	78	25	5.7	2.8	162	301	378
1308	250	220	78	25	6.7	3.2	195	362	455

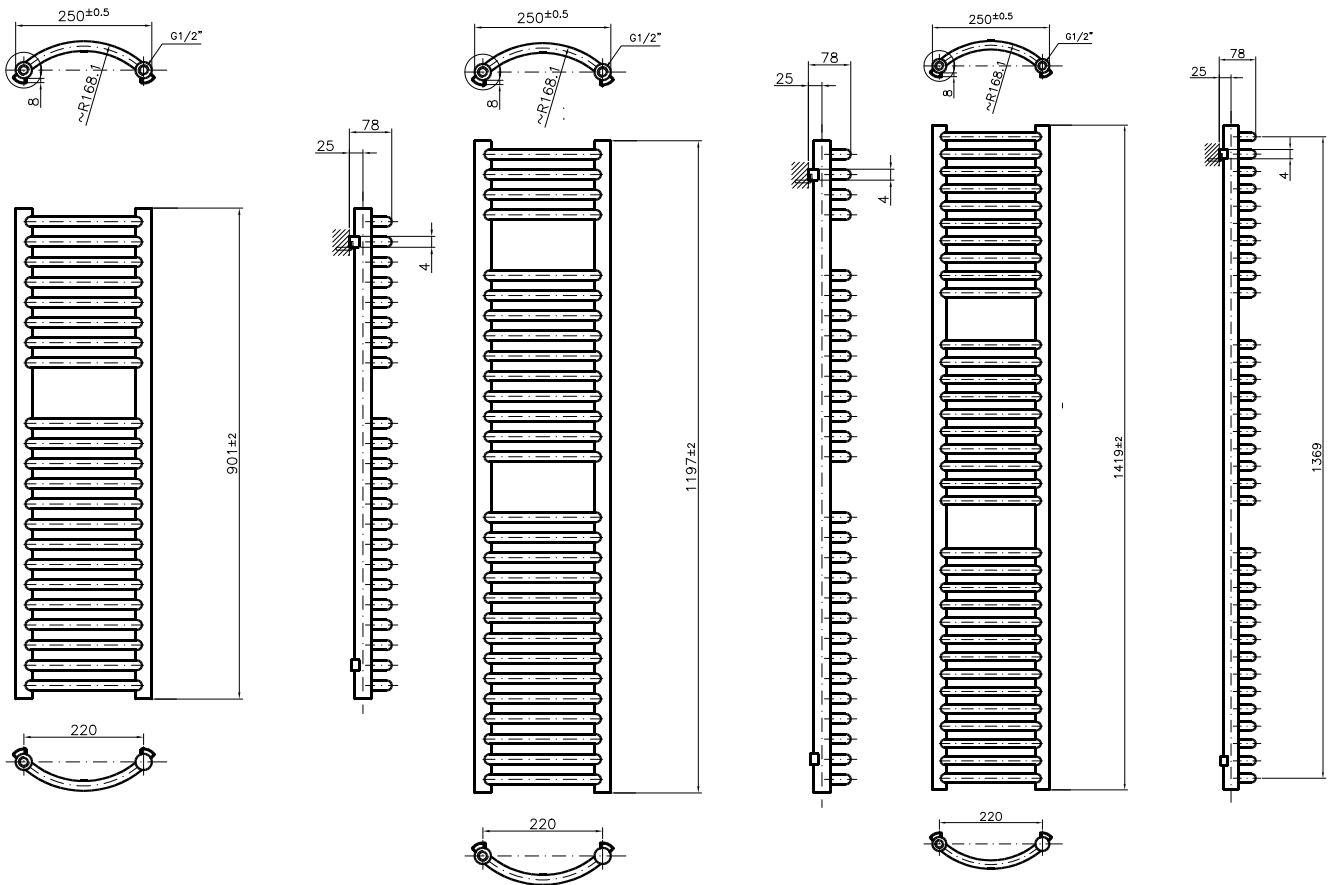

Universal, narrow, subtle

This is a radiator which can be mounted in a corner or directly on a wall. Moderate and practical, only 250 mm wide, blends into any surroundings.

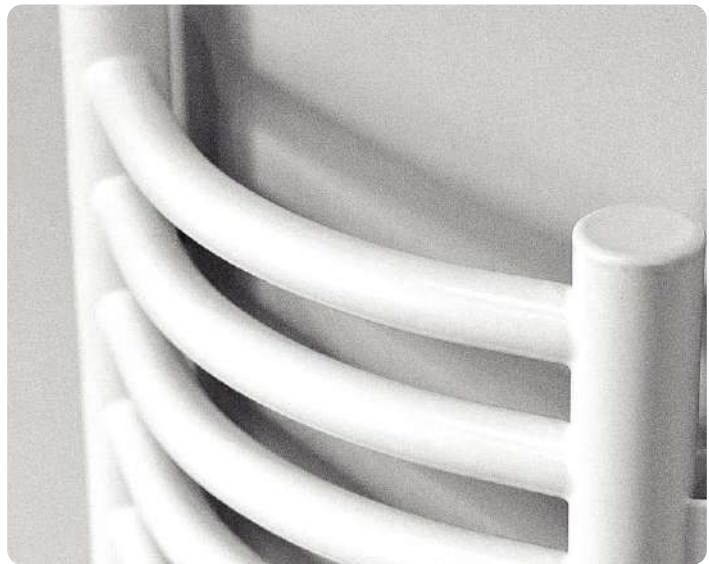

- › **Vertical pipes:** round Ø 30
- › **Horizontal bent pipes:** round Ø 18
- › **Detail work:** radiator made from low-carbon steel with powder coated finish
- › **Standard colours:** white RAL 9003 or anthracite RAL 7016
- › **Mounting:** mounting kit included
- › **Further information:** non standard size, electric heater or heater assembly on the right side available to order, mounting in the corner available



› **Types of connections:** page 184-185

› **Recommended valves kits** details on pages 178-179



Standard connections



Axial valve



Straight valve



Angular valve

6+2
WARRANTY

2 additional years of warranty when purchasing valves

info@luxrad.com

139

BARVA



Height [mm]	Width [mm]	Collector Spacing [mm]	głębokość	Space between wall and power slots [mm]	Radiator Weight [kg]	Radiator capacity [dm ³]	Power level [W] 55/45/20	power level [W] 75/65/20	Power level [W] 90/70/20
720	500	470	61-71	46-56	5.4	3	159	295	371
720	600	570	61-71	46-56	6.6	3.9	191	354	445
960	500	470	61-71	46-56	7.5	4.3	220	408	513
960	600	570	61-71	46-56	8.8	4.8	264	489	615
1320	500	470	61-71	46-56	9.9	5.1	290	538	676
1320	600	570	61-71	46-56	11.9	5.5	352	653	821
1680	500	470	61-71	46-56	12.4	5.8	363	673	846
1680	600	570	61-71	46-56	15	6.9	437	810	1018
1880	500	470	61-71	46-56	14	6.5	393	728	915
1880	600	570	61-71	46-56	16.5	7.6	471	874	1099

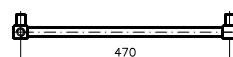
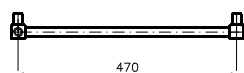
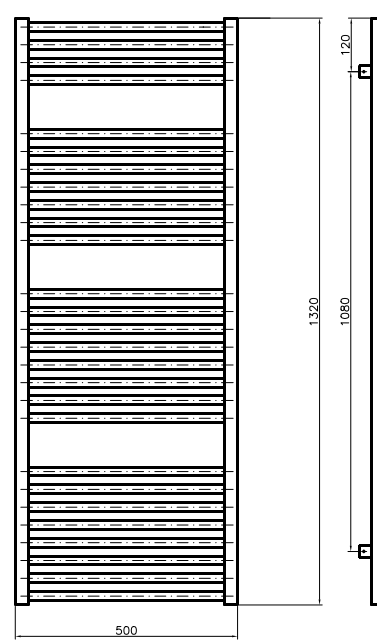
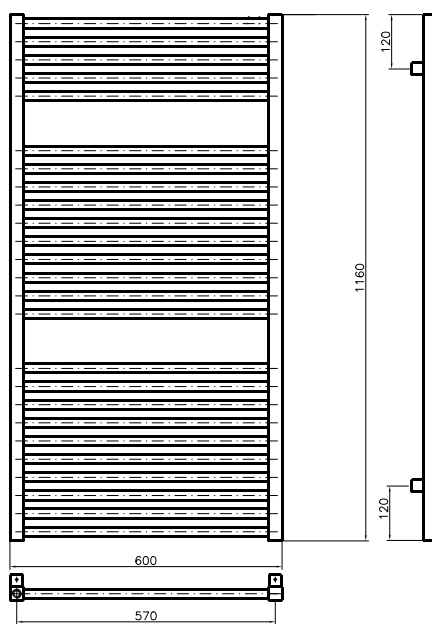
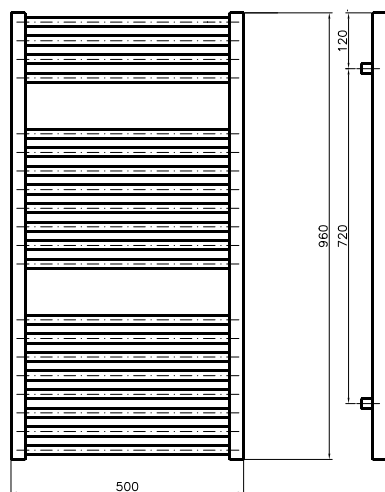
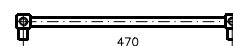
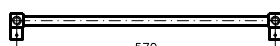
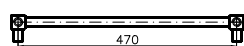

Something for youngsters

Classical shapes, vertical square pipes and horizontal round pipes create a product whose form can only be branded "cool". For all those who are, or who wish to remain young.



- › **Vertical pipes:** square 30 x 30 mm
- › **Horizontal straight pipes:** round Ø 18
- › **Detail work:** radiator made from low-carbon steel with powder coated finish
- › **Standard colours:** white RAL 9003 or anthracite RAL 7016
- › **Mounting:** mounting kit included
- › **Further information:** non standard size, electric heater or heater assembly on the right side available to order



› **Types of connections:** page 184-185

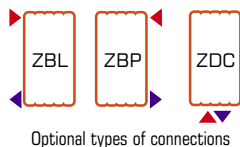
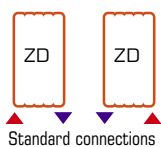

› **Recommended valves kits** details on pages 178-179

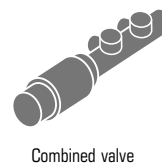

6+2
WARRANTY

2 additional years
of warranty
when purchasing
valves

info@luxrad.com

141

GAJA



Height [mm]	Width [mm]	Collector Spacing [mm]	Depth [mm]	Space between wall and power slots [mm]	Radiator Weight [kg]	Radiator capacity [dm ³]	Power level [W] 55/45/20	power level [W] 75/65/20	Power level [W] 90/70/20
764	500	470	77-96	62-81	6.4	3.2	197	365	459
764	600	570	77-96	62-81	7.4	3.7	229	425	534
764	700	670	77-96	62-81	8.4	4.1	260	483	607
1172	500	470	77-96	62-81	9.7	4.9	292	542	681
1172	600	570	77-96	62-81	11.2	5.6	340	630	792
1172	700	670	77-96	62-81	12.7	6.2	386	716	900
1691	500	470	77-96	62-81	13.8	7.1	416	772	971
1691	600	570	77-96	62-81	16	8	481	892	1122
1691	700	670	77-96	62-81	18	9	550	1020	1283

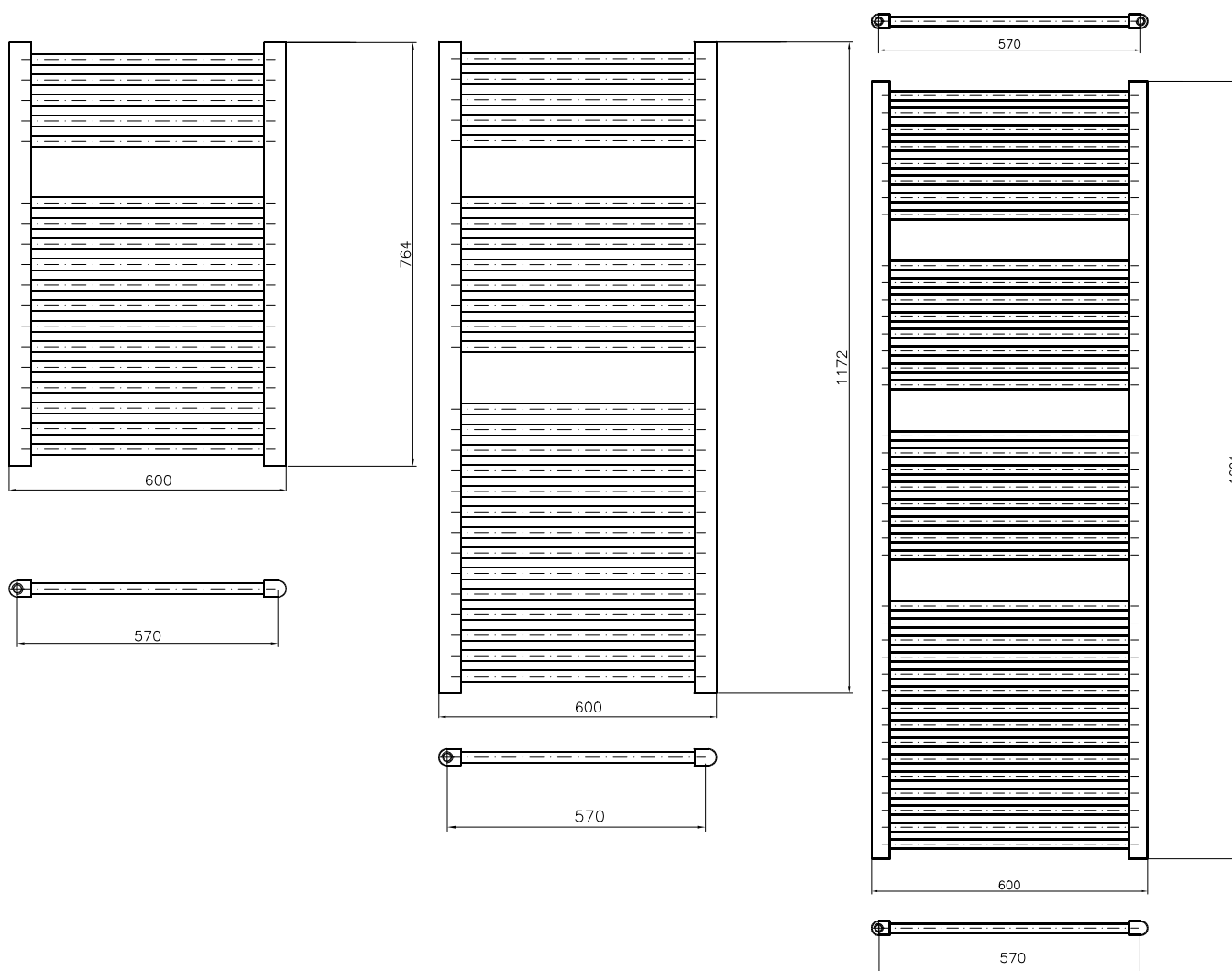

Timeless elegance

A classic radiator. It catches with its modest elegance and a timeless stylish line. Thanks to the clear form, Gaia can be used in various ways. It ideally suits every bathroom as a towel dryer or - just - a beautiful looking interior design element. It not only heats but shapes the interior as well.



- › **Vertical pipes:** made on profile D 40 x 30 mm
- › **Horizontal straight pipes:** round Ø 20
- › **Detail work:** radiator made from low-carbon steel with powder coated finish
- › **Standard colours:** white RAL 9003 or anthracite RAL 7016
- › **Mounting:** mounting kit included
- › **Further information:** non standard size, heater assembly or electric heater available to order



› **Types of connections:** page 184-185

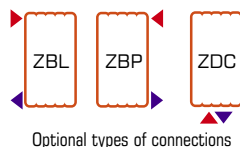
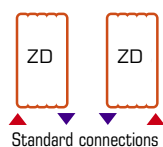

› **Recommended valves kits** details on pages 178-179

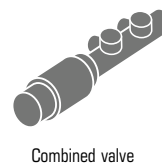

6+2
WARRANTY

2 additional years of warranty when purchasing valves

info@luxrad.com

143

SATURN



Height [mm]	Width [mm]	Collector Spacing [mm]	Depth [mm]	Space between wall and power slots [mm]	Radiator Weight [kg]	Radiator capacity [dm ³]	Power level [W] 55/45/20	power level [W] 75/65/20	Power level [W] 90/70/20
764	497	467	80-92	57-69	6.4	3.2	197	365	459
764	595	565	80-92	58-70	7.4	3.7	229	425	534
764	692	662	86-92	62-68	8.4	4.1	260	483	607
1172	497	467	80-92	57-69	9.7	4.9	292	542	681
1172	595	565	80-92	58-70	11.2	5.6	340	630	792
1172	692	662	86-92	62-68	12.7	6.2	386	716	900
1691	497	467	80-92	57-69	13.8	7.1	416	772	971
1691	595	565	80-92	58-70	16	8	481	892	1122
1691	692	662	86-92	62-68	18	9	550	1020	1283

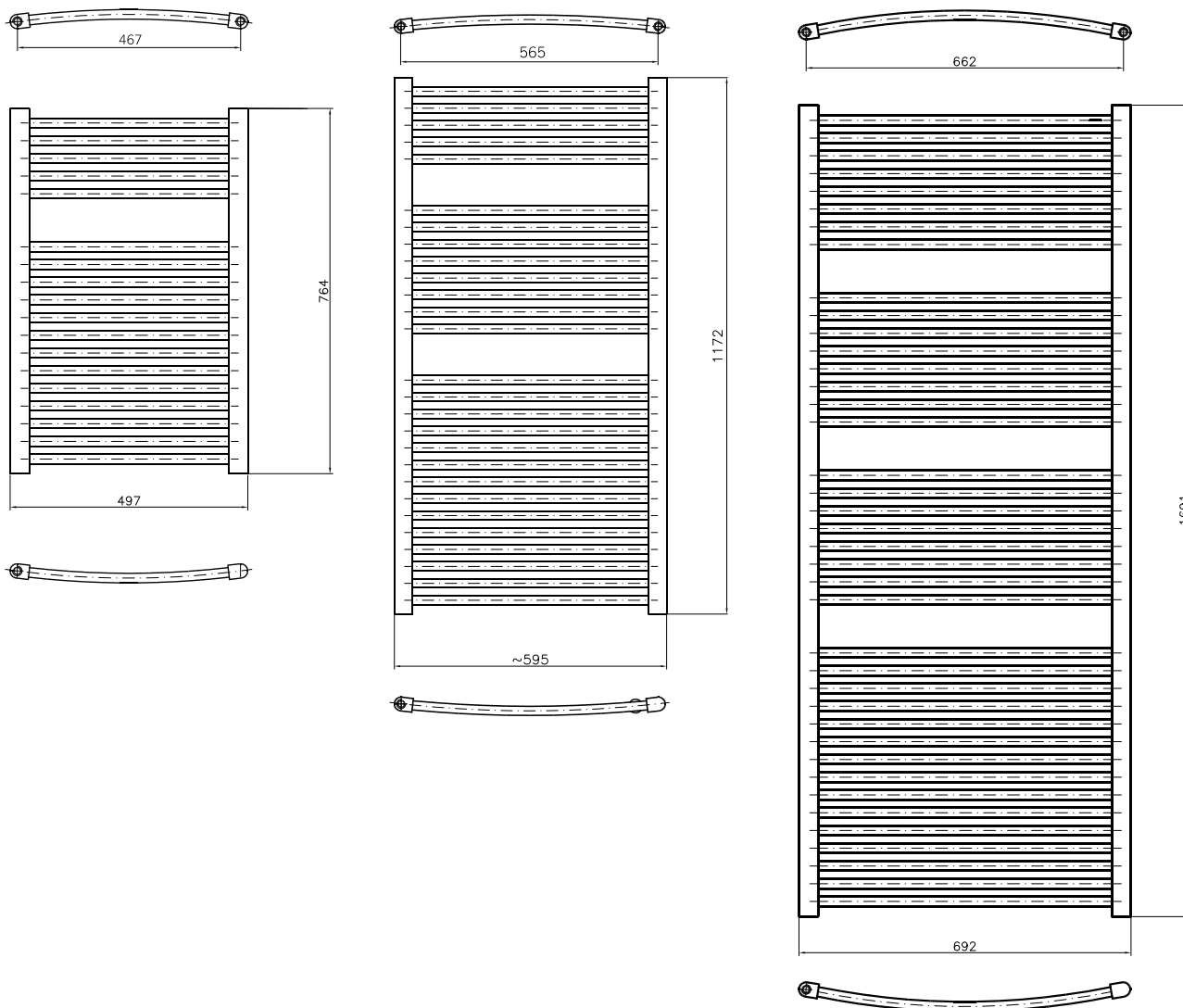

SATURN



Arched, Classic

Characterised by a beautifully designed half rounded side pipes, which harmoniously blends thanks to its toned curvatures. A high quality construction, coupled with convincing parameters, make this a model which can be used in any place in any situation.



- › **Vertical pipes:** made on profile D 40 x 30 mm
- › **Horizontal straight pipes:** round Ø 20
- › **Detail work:** radiator made from low-carbon steel with powder coated finish
- › **Standard colours:** white RAL 9003 or anthracite RAL 7016
- › **Mounting:** mounting kit included
- › **Further information:** non standard size, heater assembly or electric heater available to order



› **Types of connections:** page 184-185

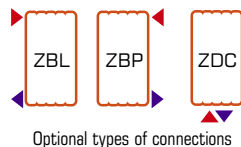
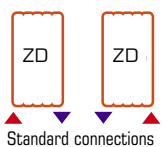

› **Recommended valves kits** details on pages 178-179

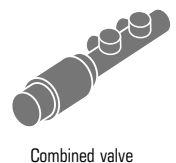
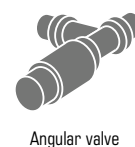

6+2
WARRANTY

2 additional years
of warranty
when purchasing
valves

info@luxrad.com

145

REGULAR



Height [mm]	Width [mm]	Collector Spacing [mm]	Depth [mm]	Space between wall and power slots [mm]	Radiator Weight [kg]	Radiator capacity [dm ³]	Power level [W] 55/45/20	power level [W] 75/65/20	Power level [W] 90/70/20
760	300	270	77-96	62-81	3.3	1.8	105	196	246
760	500	470	77-96	62-81	5.4	3	176	326	410
760	600	570	77-96	62-81	6.2	3.4	202	375	471
1160	300	270	77-96	62-81	5	2.8	159	295	371
1160	500	470	77-96	62-81	8.3	4.6	265	491	617
1160	600	570	77-96	62-81	9.5	5.2	305	565	710
1480	300	270	77-96	62-81	6.3	3.6	199	369	464
1480	500	470	77-96	62-81	10.5	5.8	332	615	773
1480	600	570	77-96	62-81	12	6.5	382	708	890
1720	500	470	77-96	62-81	12.1	6.7	378	701	881
1720	600	570	77-96	62-81	13.7	7.5	435	806	1013

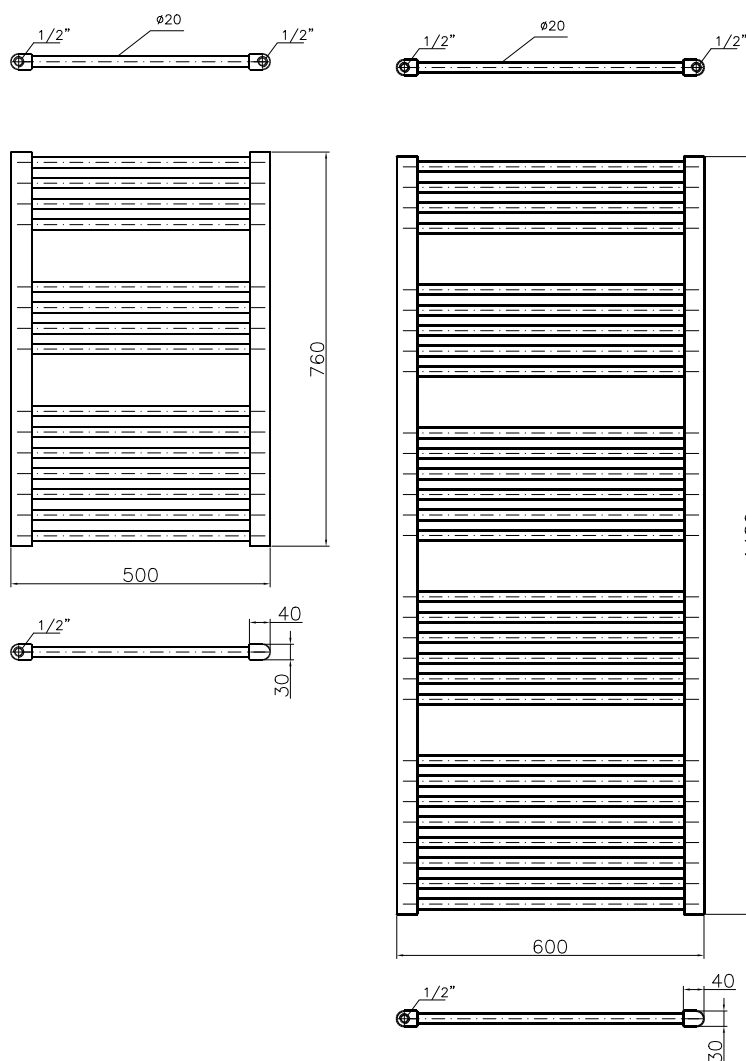

REGULAR



Straightforward and economical

A traditional bathroom radiator. Through vertical pipes in the form of the letter D, interesting visuals are achieved. Perfectly placed horizontal pipes guarantee exceptional functionality.



- › **Vertical pipes:** made on profile D
- › **Horizontal bent pipes:** round Ø 20
- › **Detail work:** radiator made from low-carbon steel with powder coated finish
- › **Standard colours:** white RAL 9003 or anthracite RAL 7016
- › **Mounting:** mounting kit included
- › **Further information:** non standard size, heater assembly or electric heater available to order



› **Types of connections:** page 184-185

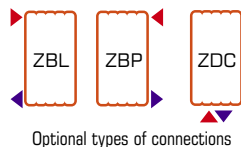
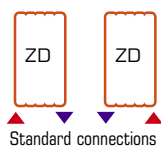

› **Recommended valves kits** details on pages 178-179

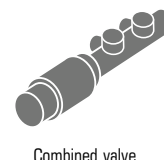
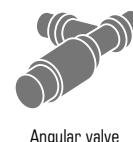

6+2
WARRANTY

2 additional years
of warranty
when purchasing
valves

info@luxrad.com

147

REGULAR CURVED



Height [mm]	Width [mm]	Collector Spacing [mm]	Depth [mm]	Space between wall and power slots [mm]	Radiator Weight [kg]	Radiator capacity [dm ³]	Power level [W] 55/45/20	power level [W] 75/65/20	Power level [W] 90/70/20
760	497	467	80-92	57-69	5.4	3	176	326	410
760	595	565	80-92	58-70	6.2	3.4	202	375	471
1160	497	467	80-92	57-69	8.3	4.6	265	491	617
1160	595	565	80-92	58-70	9.5	5.2	305	565	710
1480	497	467	80-92	57-69	10.5	5.8	332	615	773
1480	595	565	80-92	58-70	12	6.5	382	708	890
1720	497	467	80-92	57-69	12.1	6.7	378	701	881
1720	595	565	80-92	58-70	13.7	7.5	435	806	1013

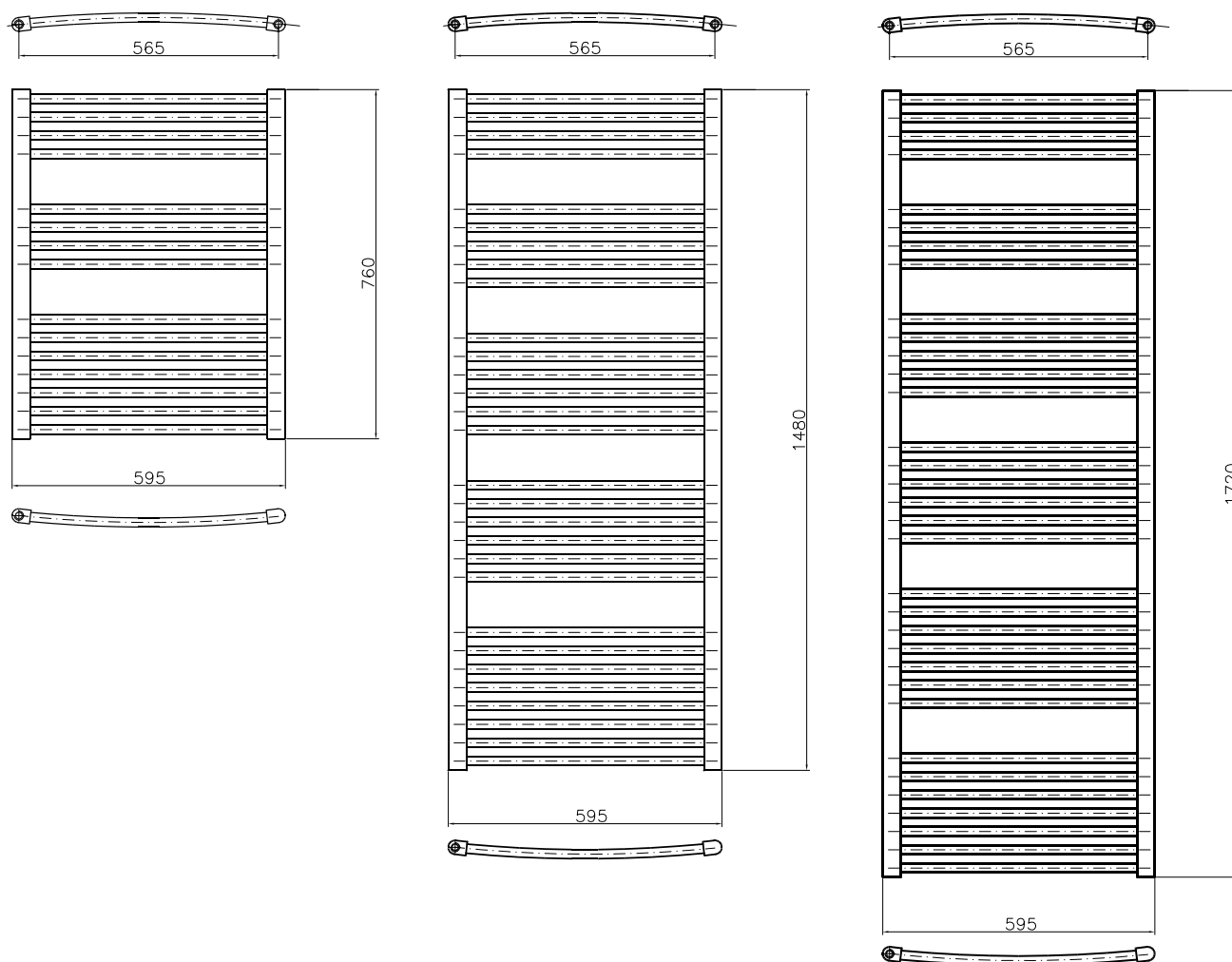

REGULAR CURVED



Intresting curved design

An intriguing, curved model from the basic series. Its design and quality combined with practicality makes this product suitable in any bathroom setting.



- › **Vertical pipes:** made on profile D
- › **Horizontal pipes:** round Ø 20
- › **Detail work:** radiator made from low-carbon steel with powder coated finish
- › **Standard colours:** white RAL 9003 or anthracite RAL 7016
- › **Mounting:** mounting kit included
- › **Further information:** non standard size, heater assembly or electric heater available to order



› **Types of connections:** page 184-185

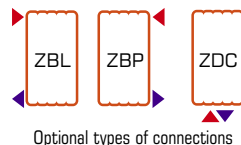
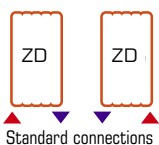

› **Recommended valves kits** details on pages 178-179

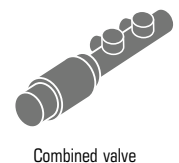
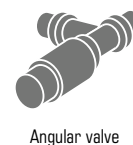

6+2
WARRANTY

2 additional years
of warranty
when purchasing
valves

info@luxrad.com

149





CHROME RADIATORS

● L1	152-153
● L2	154-155
● L4	156-157
● NIAGARA CHROME	158-159

L1



Height [mm]	Width [mm]	Collector Spacing [mm]	Depth [mm]	Space between wall and power slots [mm]	Radiator Weight [kg]	Radiator capacity [dm ³]	Power level [W] 55/45/20	Power level [W] 75/65/20	Power level [W] 90/70/20
916	450	420	77-96	62-81	6.7	3.8	180	335	421
916	600	570	77-96	62-81	7.5	4.8	202	375	471
1264	450	420	77-96	62-81	9.9	10	240	445	559
1264	600	570	77-96	62-81	11.6	12.3	267	495	622

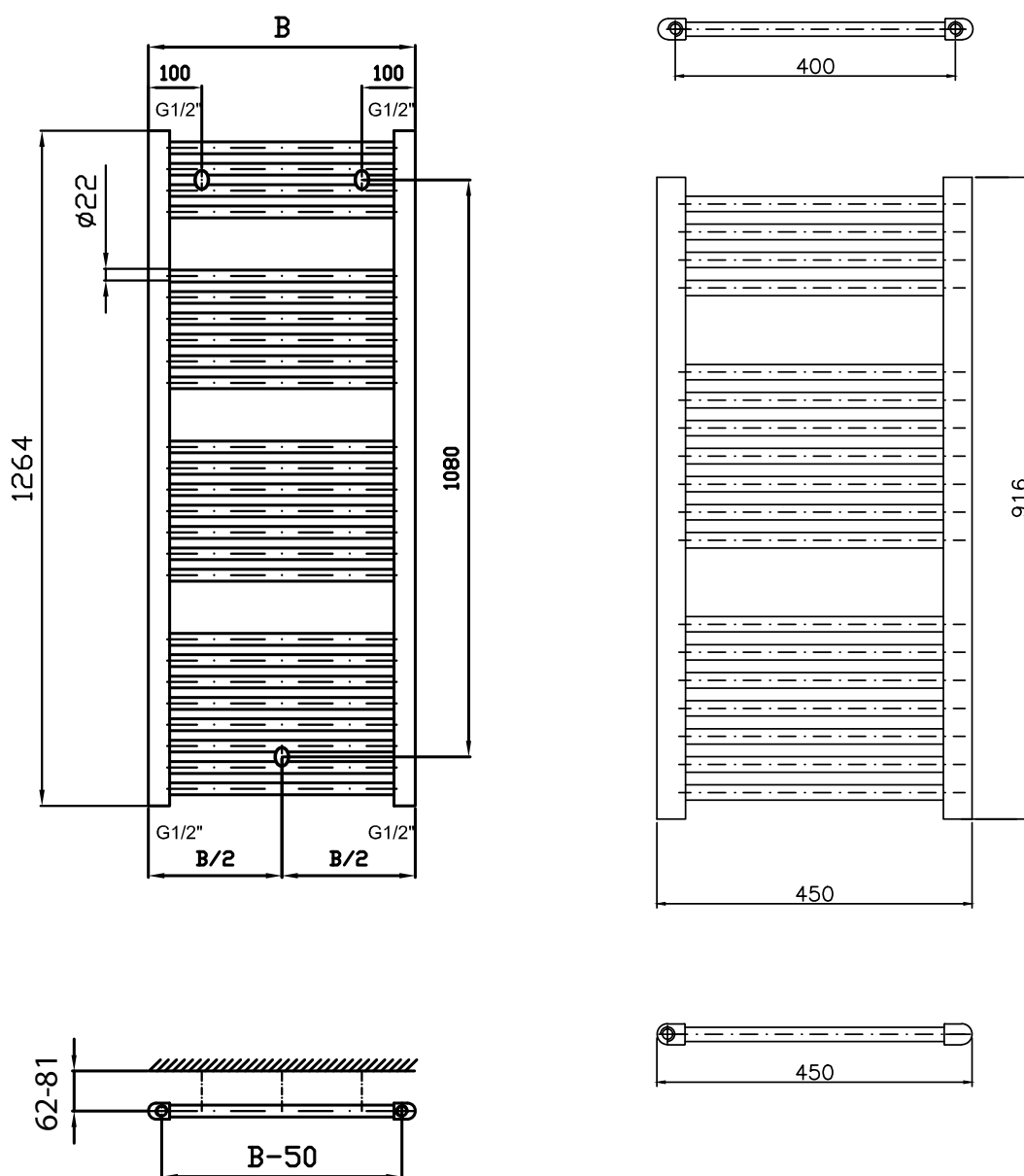

Has something in it

A combination of simplicity and elegance creates an aesthetic form. The classical design fills every room with that special something. A radiator for all occasions. Humble, and noble.



- › **Vertical pipes:** made on profile D 40 x 30 mm
- › **Horizontal straight pipes:** round Ø 20
- › **Detail work:** galvanic chrome
- › **Mounting:** mounting kit included
- › **Further information:** electric heater and heater assembly available to order



Chrome radiator



Warranty



Maximum temperature



Maximum work pressure



Electric version available



Hydro-electric version available

› **Types of connections:** page 184-185

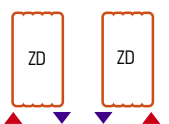

Standard connections

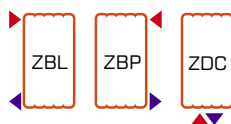

Optional types of connections

› **Recommended valves kits** details on page 178-179



Axial valve



Straight valve



Angular valve

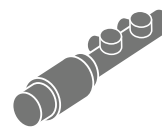

Combined valve

6+2
WARRANTY

2 additional years of warranty when purchasing valves

info@luxrad.com

153

Height [mm]	Width [mm]	Collector Spacing [mm]	Depth [mm]	Space between wall and power slots [mm]	Radiator Weight [kg]	Radiator capacity [dm ³]	Power level [W] 55/45/20	Power level [W] 75/65/20	Power level [W] 90/70/20
916	450	420	79-98	54-73	6.7	3.8	180	335	421
916	600	570	78-97	56-75	7.5	4.8	202	375	471
1264	450	420	79-98	54-73	9.9	10	240	445	559
1264	600	570	78-97	56-75	11.6	12.3	267	495	622

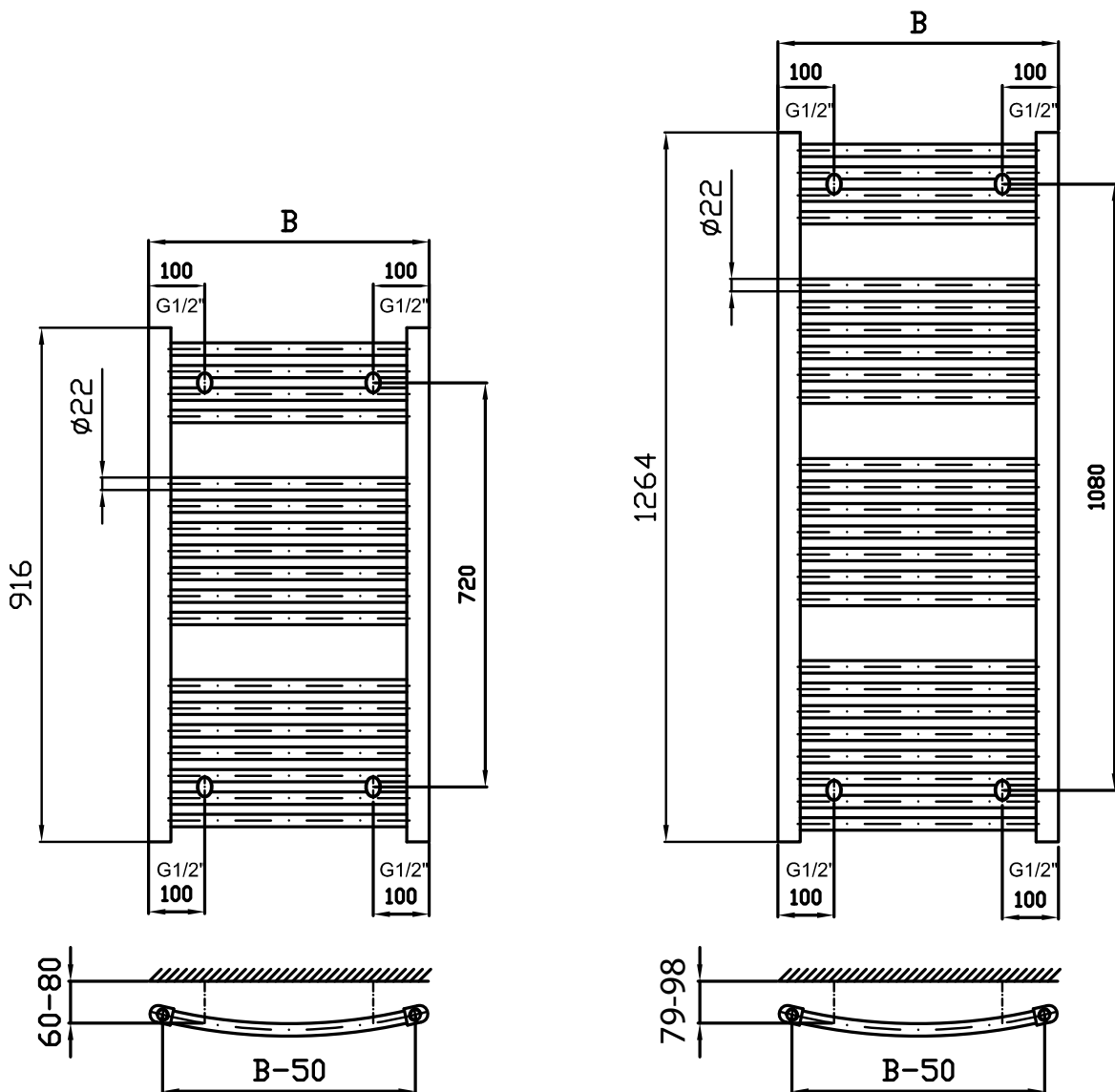

L2



Subtle, Chrome curved

An arched version of a chrome classic design. Constructed from vertical pipes in the form of the letter D with perfectly combined with slightly curved round pipes create a gentle form and subtle appearance which suits perfectly in any bathroom.



- › **Vertical pipes:** made on profile D 40 x 30 mm
- › **Horizontal straight pipes:** round Ø 20
- › **Detail work:** galvanic chrome
- › **Mounting:** mounting kit included
- › **Further information:** electric heater and heater assembly available to order



Chrome radiator



Warranty



Maximum temperature



Maximum work pressure



Electric version available



Hydro-electric version available

› **Types of connections:** page 184-185

› **Recommended valves kits** details on page 178-179

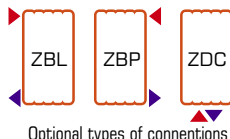
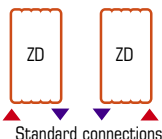

Axial valve



Straight valve



Angular valve



Combined valve

6+2
WARRANTY

2 additional years of warranty when purchasing valves

info@luxrad.com

155

L4



Height [mm]	Width [mm]	Collector Spacing [mm]	Depth [mm]	Space between wall and power slots [mm]	Radiator Weight [kg]	Radiator capacity [dm ³]	Power level [W] 55/45/20	Power level [W] 75/65/20	Power level [W] 90/70/20
740	500	470	71-81	56-66	5.6	2.8	104	194	244
740	600	570	71-81	56-66	6.4	3.1	121	225	283
1260	500	470	71-81	56-66	9.1	4.1	186	345	434
1260	600	570	71-81	56-66	10.3	4.8	202	375	471

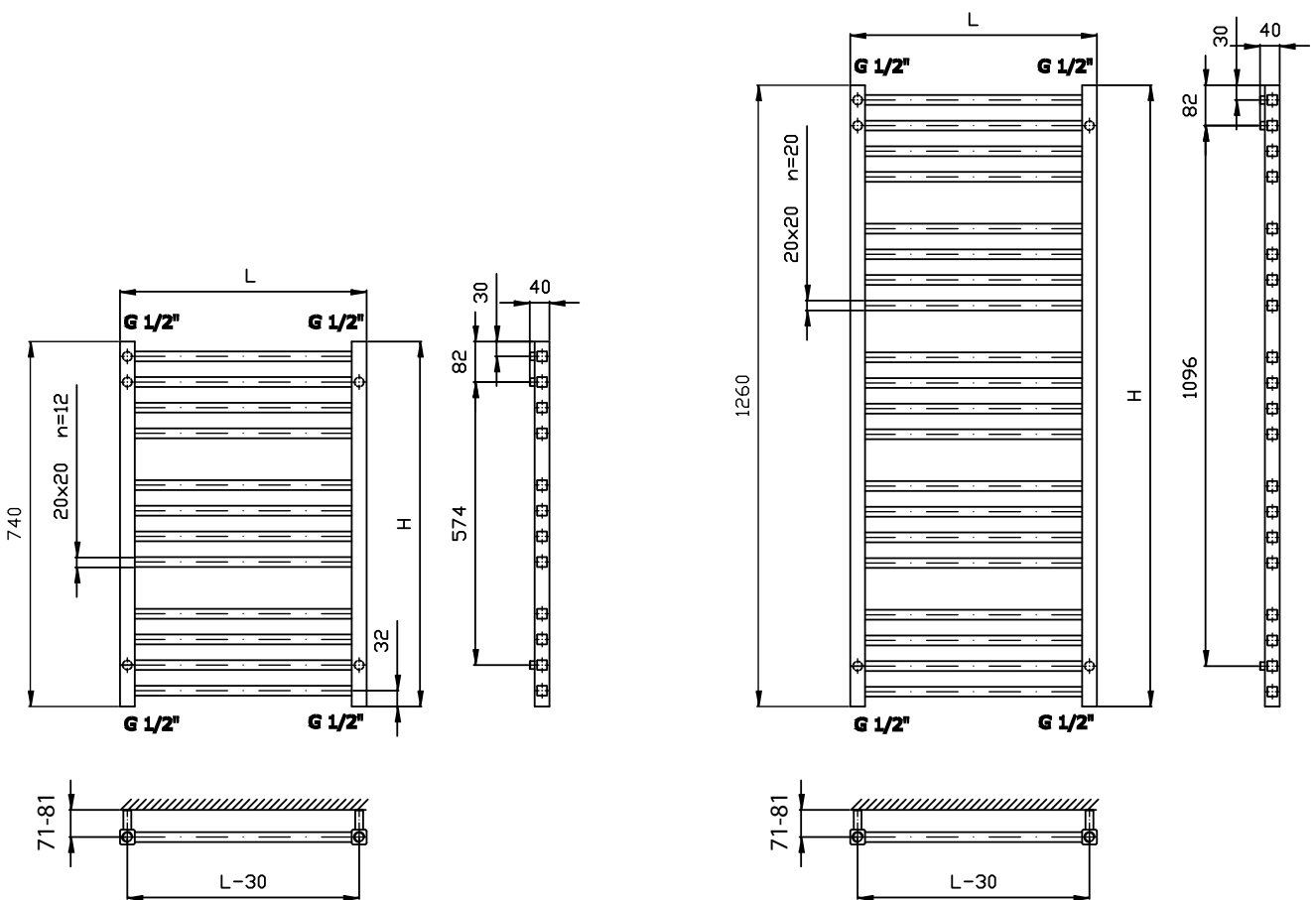

L4



Bright and simple

Modern, sharp design brings youth and spring to a room. Through straight lines this radiator provides a modern feel. For purists and those who appreciate exclusive solutions.



- › **Vertical pipes:** made on square profile 30 x 30 mm
- › **Horizontal straight pipes:** square 20 x 20
- › **Detail work:** galvanic chrome
- › **Mounting:** mounting kit included
- › **Further information:** electric heater and heater assembly available to order



Chrome radiator



Warranty



Maximum temperature



Maximum work pressure



Electric version available



Hydro-electric version available

› **Types of connections:** page 184-185

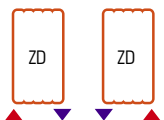

Standard connections

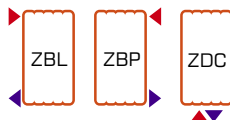

Optional types of connections

› **Recommended valves kits** details on page 178-179



Axial valve



Straight valve



Angular valve



Combined valve

6+2
WARRANTY

2 additional years
of warranty
when purchasing
valves

info@luxrad.com

157

NIAGARA CHROM



Height [mm]	Width [mm]	Collector Spacing [mm]	Depth [mm]	Space between wall and power slots [mm]	Radiator Weight [kg]	Radiator capacity [dm ³]	Power level [W] 55/45/20	Power level [W] 75/65/20	Power level [W] 90/70/20
1500	270	1468	84	62	12.6	3.5	240	445	559
1800	410	1768	84	62	24.1	6.1	427	791	995

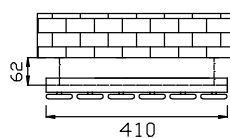
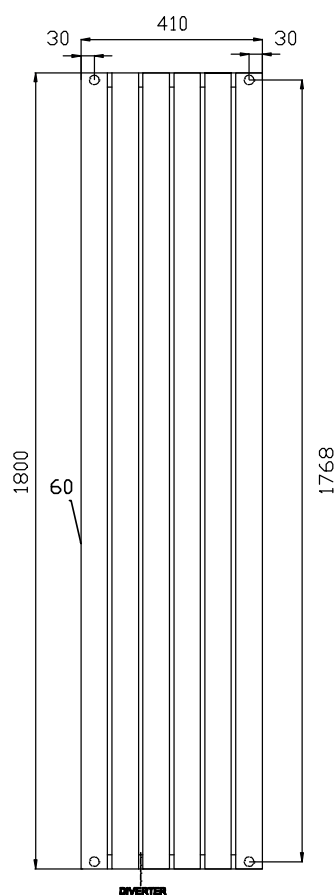
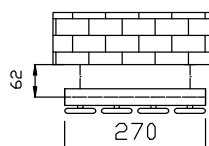
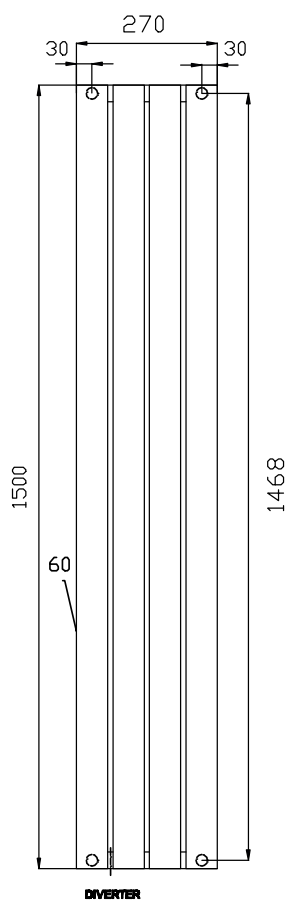

NIAGARA CHROME



Exclusive and modern

Its modern design brings a fresh new look. Through simplicity this radiator brings modern style to any room. For those who are fascinated with exclusive solutions.



- › **Horizontal pipes:** round Ø 30
- › **Vertical panels:** rectangular 8 x 50 mm
- › **Detail work:** galvanic chrome
- › **Mounting:** mounting kit included
- › **Further information:** non-standard size available to order



Chrome radiator



Warranty



Maximum temperature

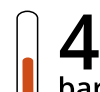

Maximum work pressure



Electric version available



Hydro-electric version available



Horizontal version available

› **Types of connections:** page 184-185

› **Recommended valves kits** details on page 178-179

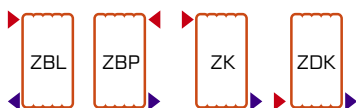

Standard connections



Axial valve



Straight valve



Angular valve

6+2
WARRANTY

2 additional years
of warranty
when purchasing
valves

info@luxrad.com

159



STAINLESS STEEL RADIATORS

● EVEREST SN	162-163
● SAHARA SN	164-165
● MAKALU	166-167
● GOCTA SN	168-169
● PIKO SN	170-171
● ATRIA SN	172-173
● TOBA SN	174-175

EVEREST SN

MADE WITH WULKAN TECHNOLOGY



Height [mm]	Width [mm]	Collector Spacing [mm]	Depth [mm]	Space between wall and power slots [mm]	Radiator Weight [kg]	Radiator capacity [dm ³]	Power level [W] 55/45/20	Power level [W] 75/65/20	Power level [W] 90/70/20
600	1 BUSHING	500	136	61	2.6	0.35	49	91	114
900	1 BUSHING	800	136	61	3.8	0.52	68	126	158
1100	1 BUSHING	1000	136	61	4.6	0.65	83	154	193
1500	1 BUSHING	1400	136	61	6.2	0.87	109	202	254
1800	1 BUSHING	1700	136	61	7.3	1.05	131	243	305
2000	1 BUSHING	1900	136	61	8.1	1.17	140	260	327
2500	1 BUSHING	2400	136	61	10.8	1.47	170	316	397

width (amount of pipe bushings): 285(4), 360(5), 435(6), 510(7), 585(8), 660(9), 735(10), 810(11), 885(12), 960(13), 1035(14), 1110(15). Selected values for 1 pipe bushing

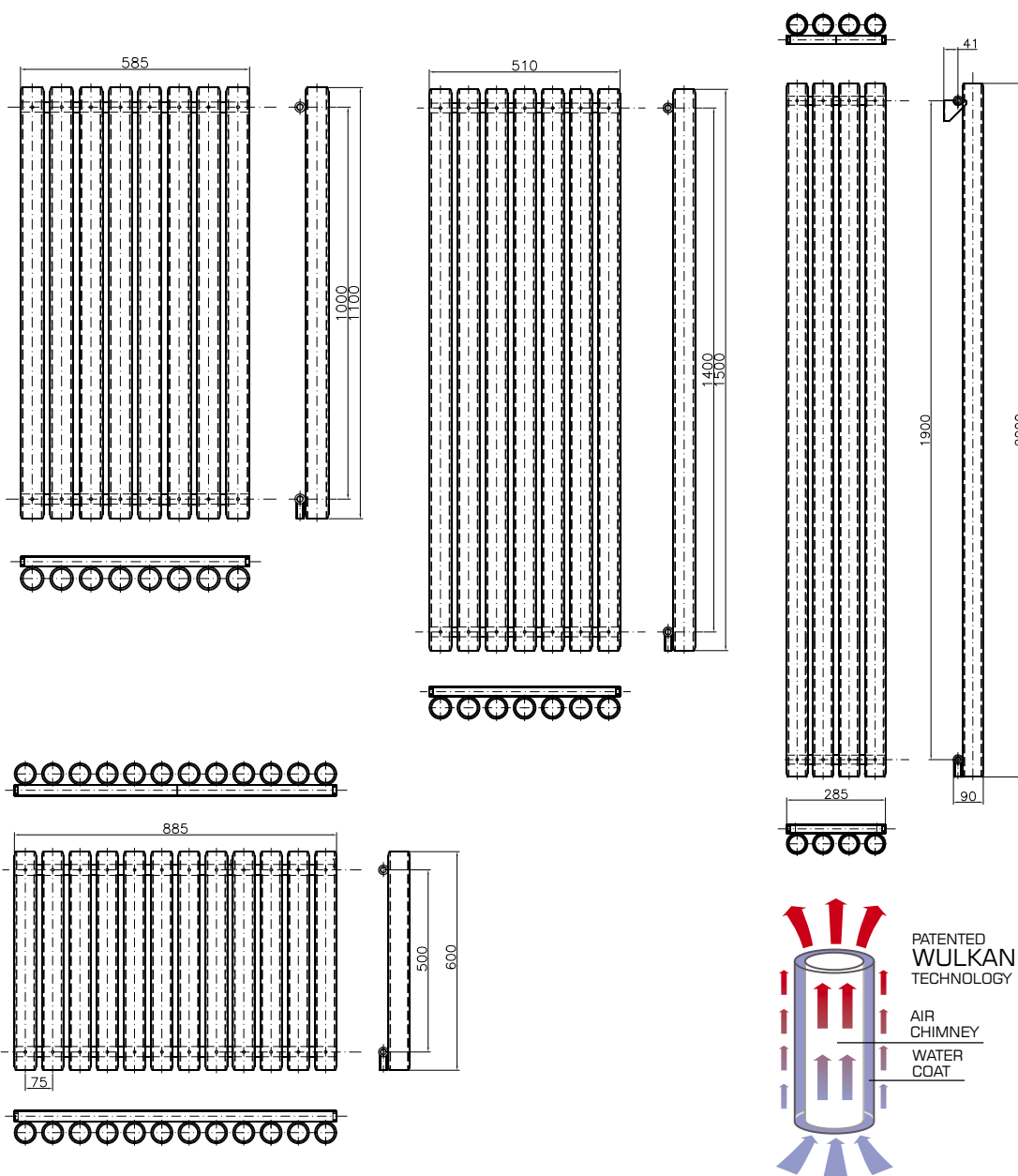

EVEREST SN

MADE WITH WULKAN TECHNOLOGY



Absolute TOP

A radiator manufactured from stainless steel incorporating Wulkan technology. This is the most exclusive model we offer: Delicate in its form, elegant, modern, original, deserving of even more eloquent adjectives. Without a doubt, these words will be repeated by those who sees EVEREST SN regardless of where it is located.



- › **Horizontal pipes:** round Ø 30
- › **Vertical pipes:** round Ø 60
- › **Detail work:** radiator made from brushed stainless steel
- › **Mounting:** mounting kit included
- › **Accessories:** radiator bracket enabling mounting to the division wall e.g. plasterboard with ease
- › **Further information:** non-standard size available to order



Stainless steel radiator



Warranty



Maximum temperature



Maximum work pressure



Electric version available



Hydro-electric version available

› **Types of connections:** page 184-185

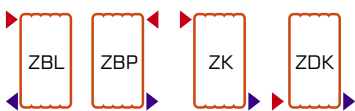

Standard connections



Types of bottom connections

› **Recommended valves kits** details page 178-179



Axial valve



Straight valve



Angular valve

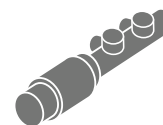

Combined valve

6+2
WARRANTY

2 additional years of warranty when purchasing valves

info@luxrad.com

163

SAHARA SN

MADE WITH WULKAN TECHNOLOGY



Height [mm]	Width [mm]	Collector Spacing [mm]	Depth [mm]	Space between wall and power slots [mm]	Radiator Weight [kg]	Radiator capacity [dm ³]	Power level [W] 55/45/20	Power level [W] 75/65/20	Power level [W] 90/70/20
600	1 BUSHING	500	106	61	0.9	0.11	17	33	41
900	1 BUSHING	800	106	61	1.4	0.17	25	48	60
1200	1 BUSHING	1100	106	61	1.9	0.23	34	64	80
1500	1 BUSHING	1400	106	61	2.4	0.29	42	79	99
1800	1 BUSHING	1700	106	61	2.8	0.34	50	94	118

width (amount of pipe bushings): 310(8), 390(10), 470(12), 550(14), 630(16), 710(18), 870(22), 1190(30).
Selected values for 1 pipe bushing

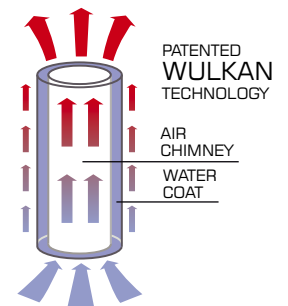
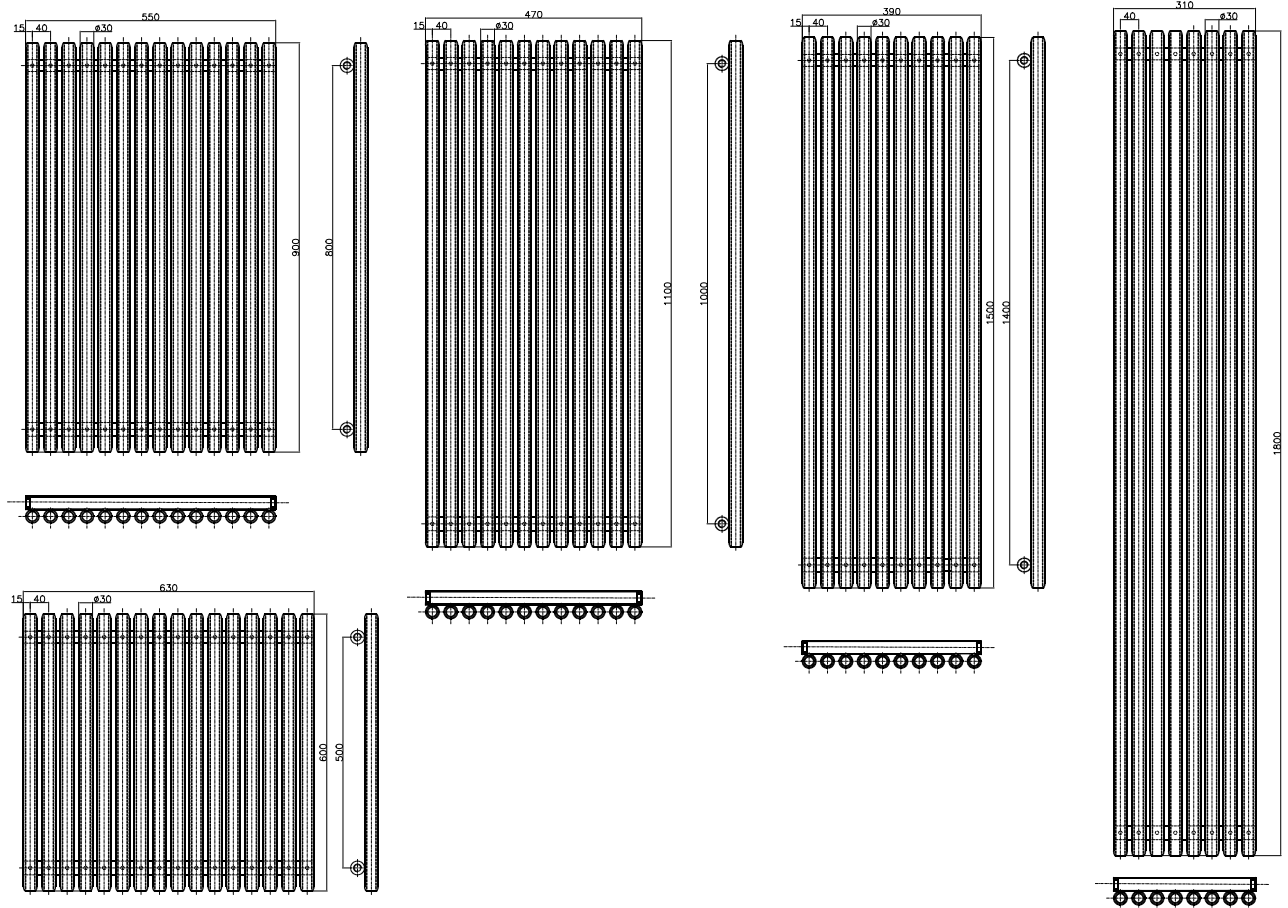

SAHARA SN

MADE WITH WULKAN TECHNOLOGY



One of a kind heat emission

This product perfectly integrates an exceptional functionality in a beautiful design. Harmoniously formed cylinders 30mm in diameter, truly satisfy aesthetic appetites.



- › **Horizontal pipes:** round Ø 30
- › **Vertical pipes:** round Ø 30
- › **Detail work:** radiator made from brushed stainless steel
- › **Mounting:** mounting kit included
- › **Accessories:** radiator bracket enabling mounting to the division wall e.g. plasterboard with ease
- › **Further information:** non-standard size available to order

INOX
Stainless steel radiator

6
YEARS
Warranty

95°C
Maximum temperature

10
bar
Maximum work pressure



› **Types of connections:** page 184-185

› **Recommended valves kits** details page 178-179

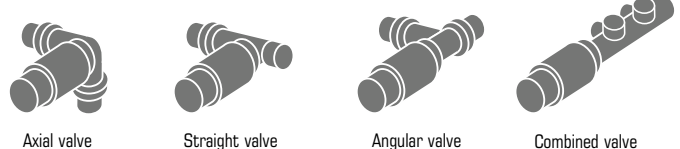
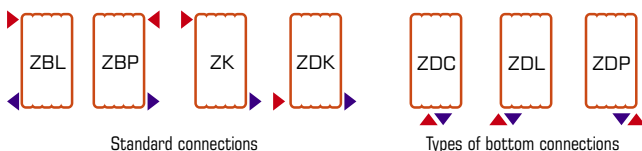

6+2
WARRANTY
2 additional years of warranty when purchasing valves

info@luxrad.com

165

MAKALU SN



Height [mm]	Width [mm]	Collector Spacing [mm]	Depth [mm]	Space between wall and power slots [mm]	Radiator Weight [kg]	Radiator capacity [dm ³]	Power level [W] 55/45/20	Power level [W] 75/65/20	Power level [W] 90/70/20
753	500	470	70-75	55-60	5.4	2.7	234	434	545
753	600	570	70-75	55-60	6.2	3.1	270	500	629
1160	500	470	70-75	55-60	8.3	4.1	348	645	811
1160	600	570	70-75	55-60	9.4	4.7	401	743	934
1678	500	470	70-75	55-60	11.9	5.9	495	918	1154
1678	600	570	70-75	55-60	13.6	6.7	571	1058	1330

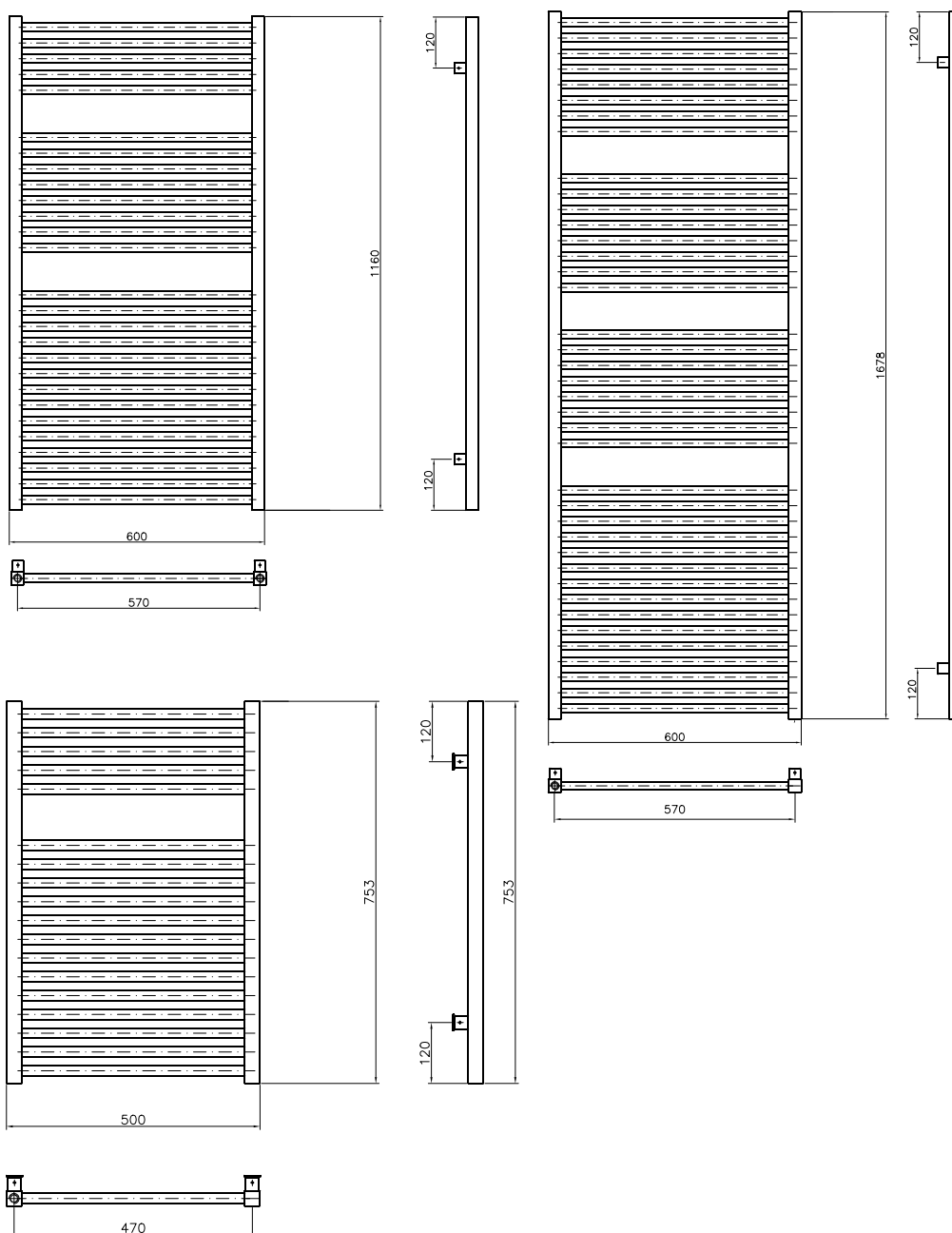

MAKALU SN



Modern and exciting

Are you looking for a specific modern form and structure? Stainless steel models offer ideal look combined with materials of the highest standard. MAKALU SN is ideal for all those who are bold and modern, who do not wish to compromise on appearance and functionality. It combines excellent durability with a beautiful exterior.



- › **Vertical pipes:** square profile 30 x 30
- › **Horizontal straight pipes:** round Ø 18
- › **Detail work:** radiator made from brushed stainless steel
- › **Mounting:** mounting kit included
- › **Further information:** non-standard size available to order

INOX
Stainless
steel radiator

6
YEARS
Warranty

95°C
Maximum
temperature

10
bar
Maximum
work pressure



Electric
version available



Hydro-electric
version available

› **Types of connections:** page 184-185

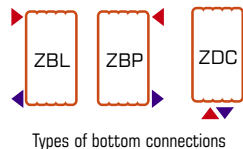
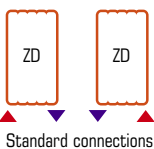

› **Recommended valves kits** details page 178-179

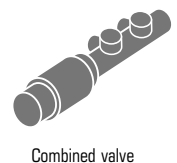
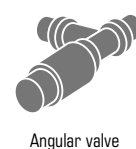

6+2
WARRANTY
2 additional years
of warranty
when purchasing
valves

info@luxrad.com

167

GOCTA SN



Height [mm]	Width [mm]	Collector Spacing [mm]	Depth [mm]	Space between wall and power slots [mm]	Radiator Weight [kg]	Radiator capacity [dm ³]	Power level [W] 55/45/20	Power level [W] 75/65/20	Power level [W] 90/70/20
720	500	450	93-103	51-61	7.7	4	264	489	615
720	600	550	93-103	51-61	8.2	4.3	301	559	703
1238	500	450	93-103	51-61	12.8	6.8	437	811	1020
1238	600	550	93-103	51-61	13.7	7.2	503	932	1172
1719	500	450	93-103	51-61	18.9	9.9	627	1162	1461
1719	600	550	93-103	51-61	20.3	10.7	721	1336	1680

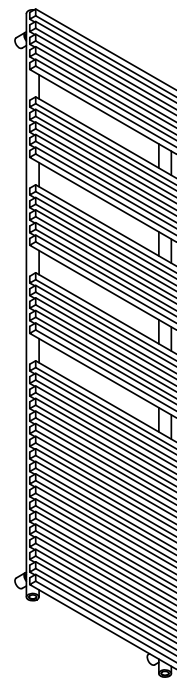
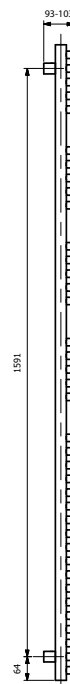
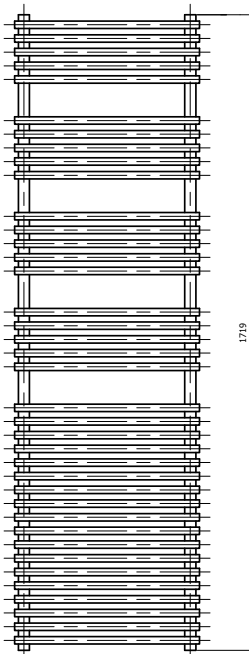
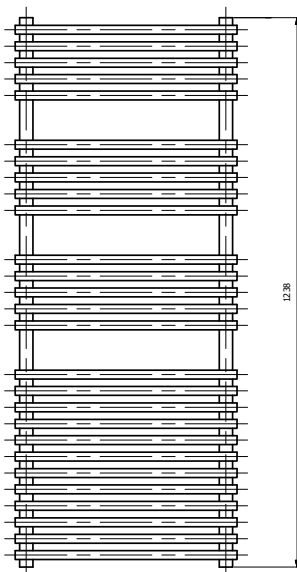
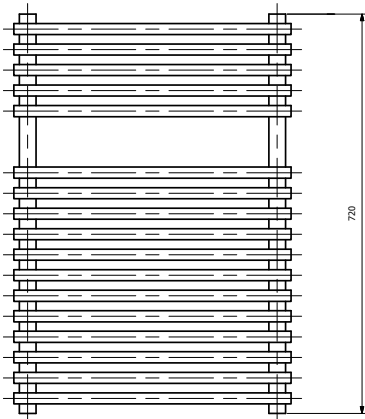
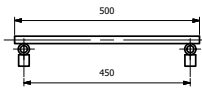
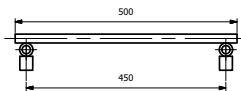
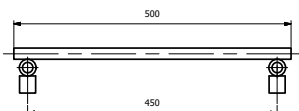

GOCTA SN



Original curvatures, Classic appearance

Plenty of space for drying and hanging towels, created by the use of special curvatures at 90 degrees. This gave rise to a radiator of modern and individual form. A valued solution, by those who appreciate modern design and practical solutions.

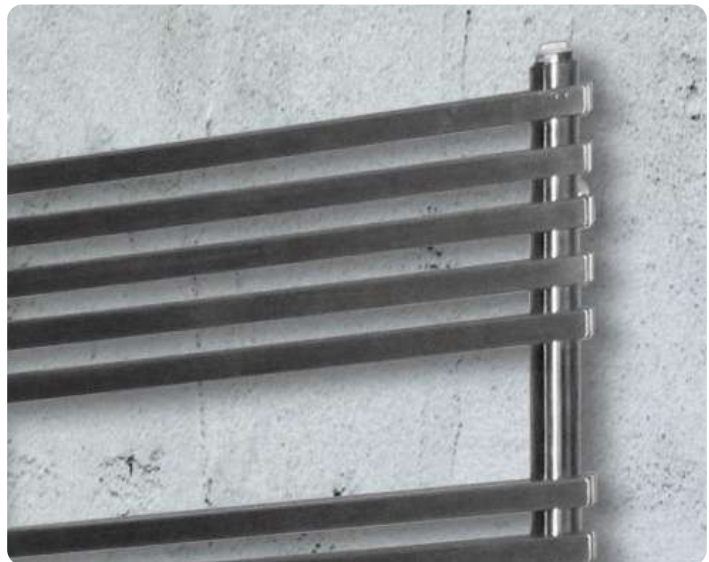

- > **Vertical pipes:** round Ø 30
- > **Horizontal straight pipes:** square 20 x 20 mm
- > **Detail work:** radiator made from brushed stainless steel
- > **Mounting:** mounting kit included
- > **Further information:** non-standard size available to order

INOX
Stainless steel radiator

6
YEARS
Warranty

95°C
Maximum temperature

10
bar
Maximum work pressure

Electric version available

Hydro-electric version available

> **Types of connections:** page 184-185

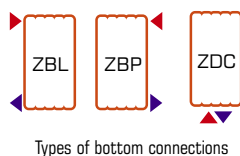
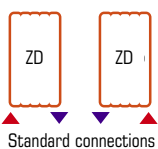

> **Recommended valves kits** details page 178-179

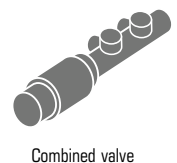
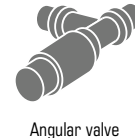

6+2
WARRANTY
2 additional years of warranty when purchasing valves

info@luxrad.com

169

PIKO SN



Height [mm]	Width [mm]	Collector Spacing [mm]	Depth [mm]	Space between wall and power slots [mm]	Radiator Weight [kg]	Radiator capacity [dm ³]	Power level [W] 55/45/20	Power level [W] 75/65/20	Power level [W] 90/70/20
720	580	470	72-91	39-58	7.4	3.2	215	399	501
720	680	570	72-91	39-58	8.4	3.2	243	451	567
1238	580	470	72-91	39-58	11.5	5.2	332	616	774
1238	680	570	72-91	39-58	12.8	5.2	375	695	874
1719	580	470	72-91	39-58	16.4	7.2	453	839	1055
1719	680	570	72-91	39-58	18.5	8.5	511	948	1192

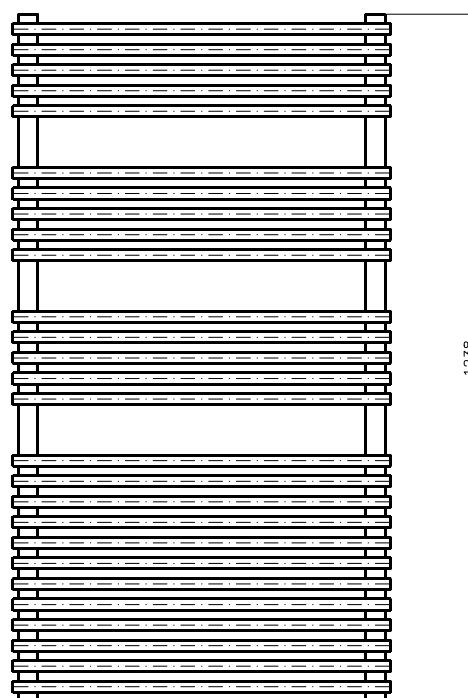
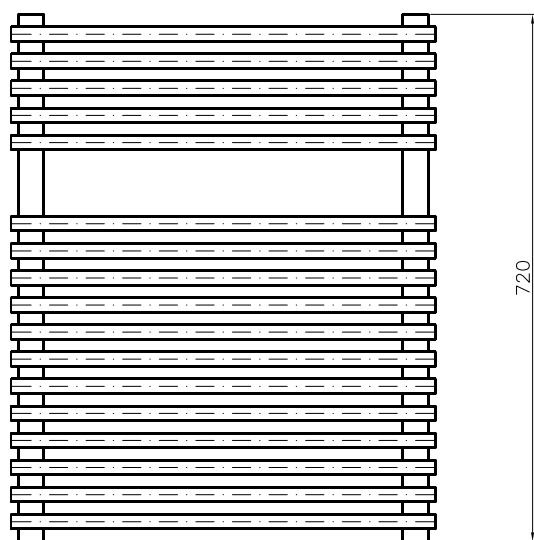
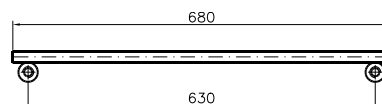
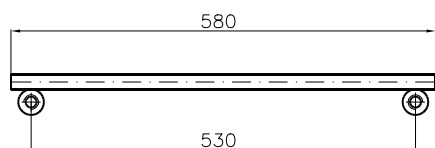

PIKO SN



It always fits

This is a popular representative of a classical form. Its clear design surpasses all temporary market trends in fashion and style meaning that PIKO is a good choice anytime and everywhere.

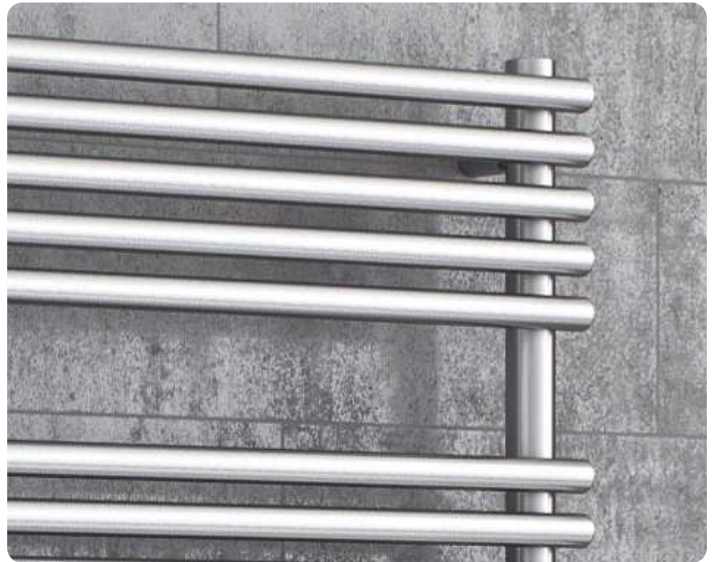
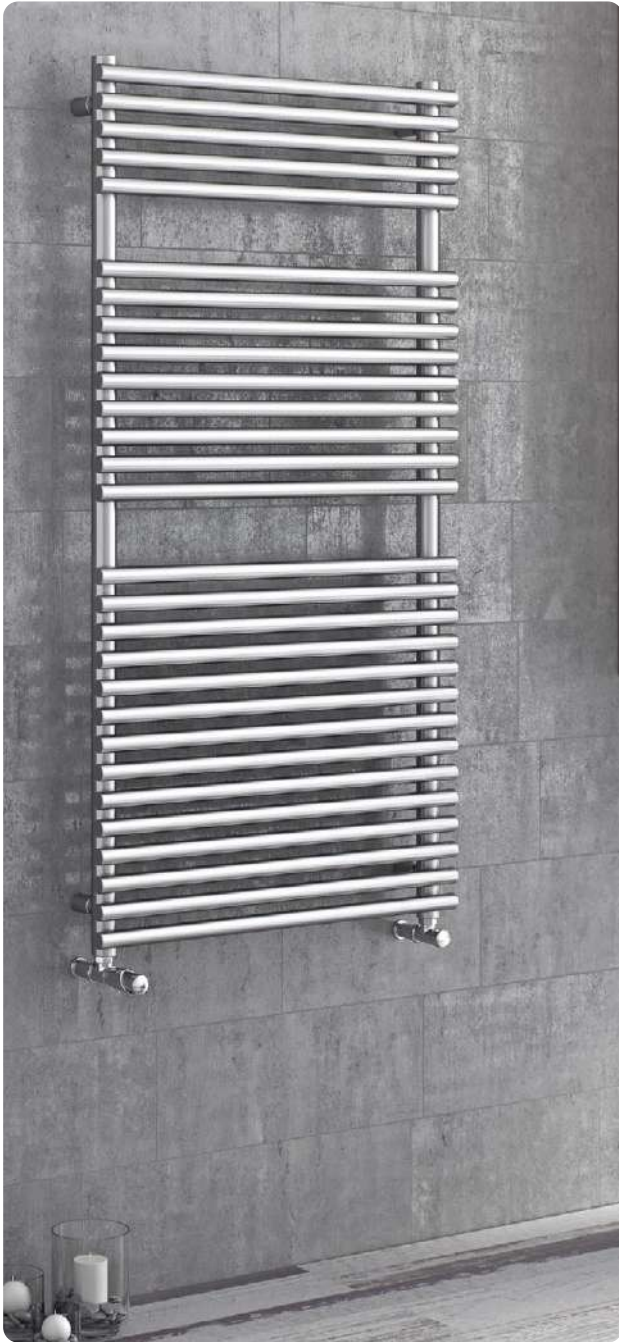

- > **Vertical pipes:** round Ø 30
- > **Horizontal pipes:** round Ø 20
- > **Detail work:** radiator made from brushed stainless steel
- > **Mounting:** mounting kit included
- > **Further information:** non-standard size available to order



> **Types of connections:** page 184-185

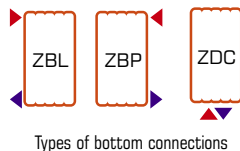
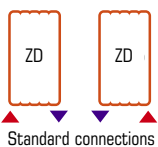

> **Recommended valves kits** details page 178-179

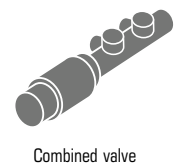

6+2
WARRANTY
2 additional years of warranty when purchasing valves

info@luxrad.com

ATRIA SN



Height [mm]	Width [mm]	Collector Spacing [mm]	Depth [mm]	Space between wall and power slots [mm]	Radiator Weight [kg]	Radiator capacity [dm ³]	Power level [W] 55/45/20	Power level [W] 75/65/20	Power level [W] 90/70/20
870	500	50	70	55	6.1	3	156	289	363
870	600	50	70	55	7	3.5	180	334	420
870	700	50	70	55	7	3.9	204	378	475
1230	500	50	70	55	8.5	4.2	217	402	505
1230	600	50	70	55	9.8	4.8	250	463	582
1230	700	50	70	55	11	5.4	282	524	659
1470	500	50	70	55	10	5	257	477	600
1470	600	50	70	55	11.6	5.7	296	549	690
1470	700	50	70	55	13	6.4	335	621	781
1710	500	50	70	55	11.6	5.7	298	553	695
1710	600	50	70	55	13.4	6.6	342	635	798
1710	700	50	70	55	15.1	7.5	387	718	903

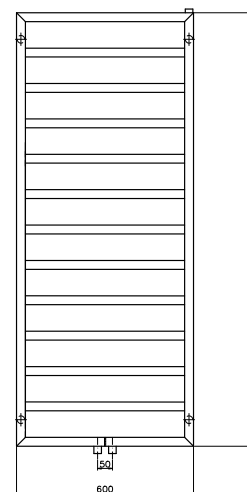
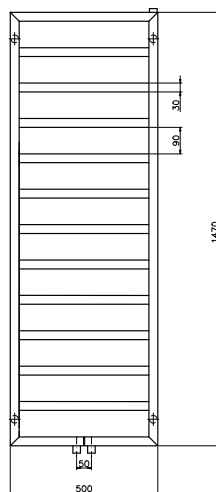
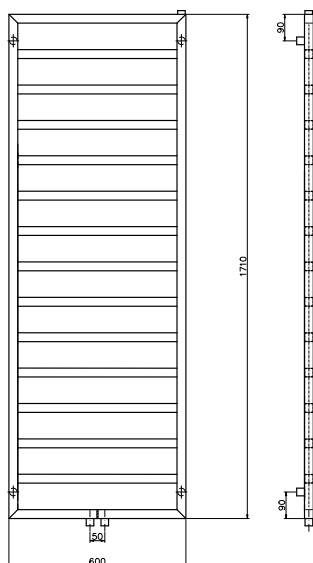
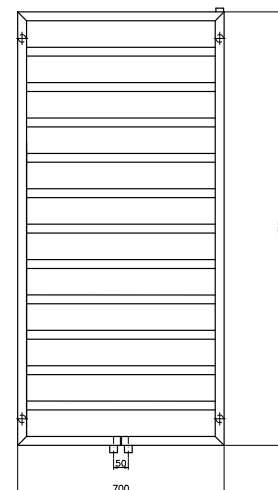
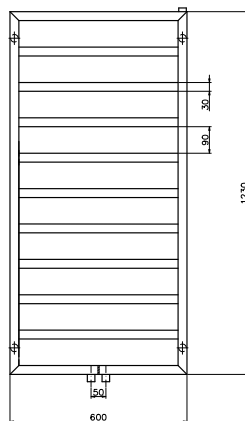
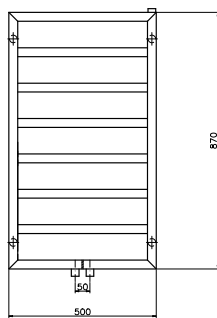

ATRIA SN



Truly Expressive

Finished in noble steel, modern trends and designs combined make this model a must for designer interiors.



- › **Vertical pipes:** square 30 x 30 mm
- › **Horizontal pipes:** square 30 x 30 mm
- › **Detail work:** radiator made from brushed stainless steel
- › **Mounting:** mounting kit included
- › **Further information:** non-standard size available to order



› **Types of connections:** page 184-185

› **Recommended valves kits** details page 178-179



Standard connections

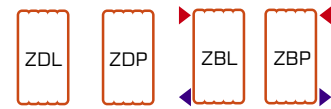

Types of bottom connections



Axial valve



Straight valve



Angular valve

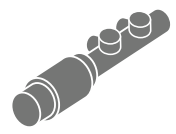

Combined valve



info@luxrad.com

173

TOBA SN



ROOM RADIATORS

BATHROOM RADIATORS

CHROME RADIATORS

STAINLESS STEEL RADIATORS

Height [mm]	Width [mm]	Collector Spacing [mm]	Depth [mm]	Space between wall and power slots [mm]	Radiator Weight [kg]	Radiator capacity [dm ³]	Power level [W155/45/20]	Power level [W175/65/20]	Power level [W190/70/20]
600	310	550	89-93	50-54	4.44	2.7	137	255	320
600	390	550	89-93	50-54	5.55	3.4	172	319	401
600	430	550	89-93	50-54	6.11	3.7	189	351	441
600	510	550	89-93	50-54	7.22	4.4	224	415	522
600	590	550	89-93	50-54	8.34	5.1	258	478	601
600	790	550	89-93	50-54	11.12	6.8	345	639	803
1000	310	950	89-93	50-54	6.91	4.3	217	403	506
1000	390	950	89-93	50-54	8.65	5.4	271	503	632
1000	430	950	89-93	50-54	9.52	5.9	298	553	695
1000	510	950	89-93	50-54	11.25	7	353	654	822
1000	590	950	89-93	50-54	12.98	8	407	754	948
1000	790	950	89-93	50-54	17.32	10.7	543	1006	1265
1200	310	1150	89-93	50-54	8.15	5.1	257	476	598
1200	390	1150	89-93	50-54	10.2	3.4	321	595	748
1200	430	1150	89-93	50-54	11.22	7	353	654	822
1200	510	1150	89-93	50-54	13.26	8.2	417	774	973
1200	590	1150	89-93	50-54	15.31	9.5	481	892	1122
1200	790	1150	89-93	50-54	20.42	12.7	642	1190	1497
1500	310	1450	89-93	50-54	10.01	6.2	315	585	735
1500	390	1450	89-93	50-54	12.52	7.8	395	733	922
1500	430	1450	89-93	50-54	13.77	8.6	435	806	1013
1500	510	1450	89-93	50-54	16.28	10.2	514	952	1197
1500	590	1450	89-93	50-54	18.79	11.7	593	1099	1382
1500	790	1450	89-93	50-54	25.06	15.6	791	1466	1844
1800	310	1750	89-93	50-54	11.87	7.4	375	696	875
1800	390	1750	89-93	50-54	14.84	9.3	470	871	1095
1800	430	1750	89-93	50-54	16.33	10.2	517	958	1205
1800	510	1750	89-93	50-54	19.3	12.1	611	1132	1424
1800	590	1750	89-93	50-54	22.28	13.9	705	1306	1642
1800	790	1750	89-93	50-54	29.71	18.6	940	1742	2191

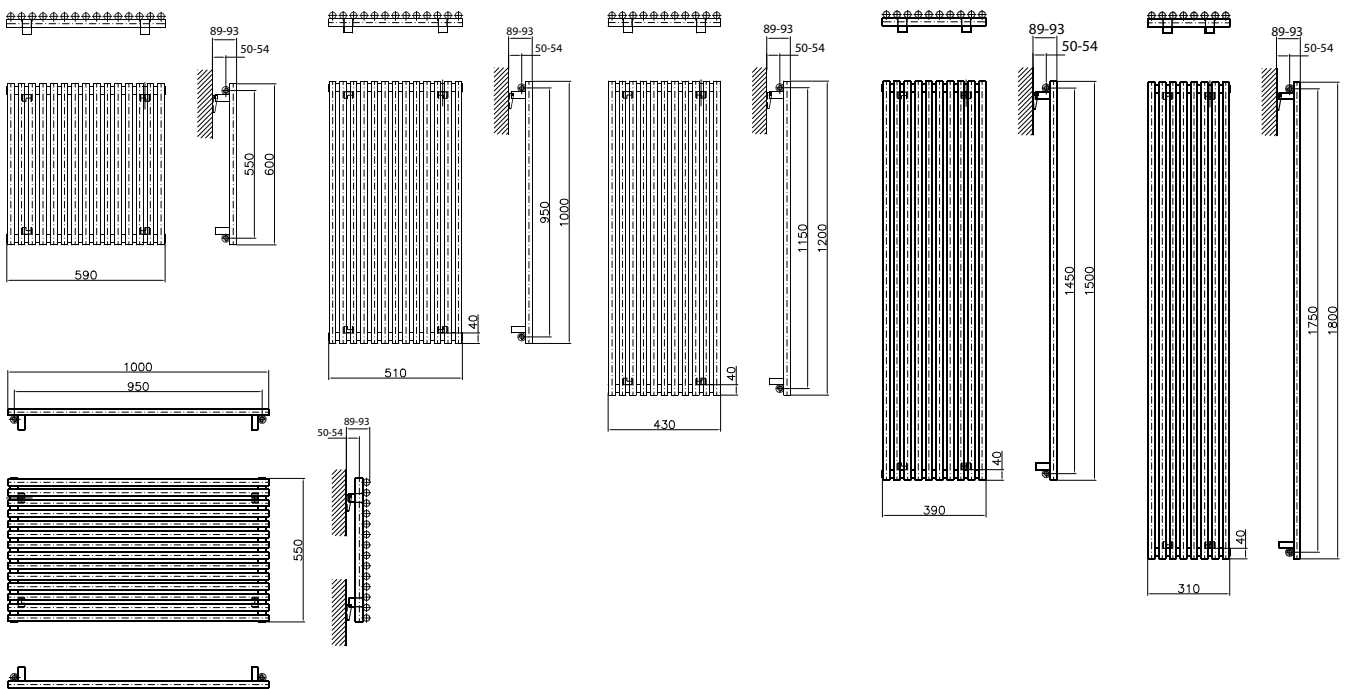

TOBA SN



Tasteful form

Thanks to its design and versatility, this radiator provides endless mounting possibilities. The horizontal version is a logical fulfillment and continuation in the range of cylindrical radiators. It enriches the form of interiors, satisfying all demands.



- › **Horizontal pipes:** round Ø 30
- › **Vertical pipes:** round Ø 25
- › **Detail work:** radiator made from brushed stainless steel
- › **Mounting:** mounting kit included
- › **Further information:** horizontal assembly available to order. Possible spacing in horizontal version 500 mm.



Stainless steel radiator



Warranty



Maximum temperature



Maximum work pressure



Electric version available



Hydro-electric version available



Horizontal version available

› **Types of connections:** page 184-185

› **Recommended valves kits** details page 178-179

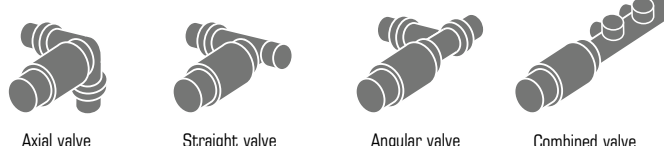
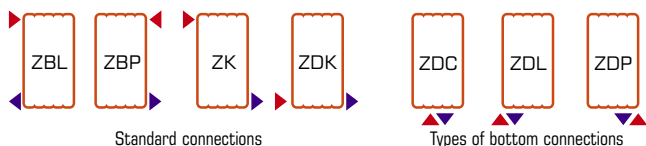

6+2
WARRANTY

2 additional years of warranty when purchasing valves

info@luxrad.com

175



NIAGARA WITH GRAPHICS

Examples of applying graphics for different widths of radiators

Radiator
1800 mm / 445 mm



Radiator
1800 mm / 525 mm



Radiator
1800 mm / 595 mm



Radiator
1800 mm / 445 mm



Radiator
1800 mm / 525 mm



Radiator
1800 mm / 595 mm



In order to meet your expectations, we provide the possibility of purchasing additional heater accessories.

These include, among others, heaters, valves or hangers.

Made in the colour of the radiator, they will perfectly complement the interior design in which our radiator will be installed.

Our products are available in colours from the RAL palette and in our special colours. Details on pages 178-187.



VALVES LUXRAD



Painted with powder

Advantages of using Luxrad valves

- 1. Saving energy** Thanks to built-in thermostat the valve regulates radiator work by itself.
- 2. Saving money** Temperature regulation means less energy used for it, thereby the bills are reduced.
- 3. Comfort** Thermostatic valves allows you to maintain a steady temperature in the room.

All radiators have 6-year warranty with the option of extending the warranty for 2 more years by purchasing Luxrad valve.

To extend warranty (8 years jointly) it is necessary to:

- Purchase the set of Luxrad valves within 7 days from radiator's buying date
- Keep the receipt together with the warranty card

SAVE UP TO



ON ENERGY

COSTS

STRAIGHT VALVE KIT

Straight thermostatic valve 1/2 "x 1/2"
Thermostatic head
Colour: WHITE / ANTHRACITE, CHROME, BLACK RAL 9005, MATTE BLACK, JANUARY 2, MATTE BLACK PAGE OR ANY COLOUR



ANGLE VALVE KIT

Angular valve 1/2" x 1/2", angle return valve 1/2" x 1/2", thermostatic head
Colour: WHITE / ANTHRACITE, CHROME, QUARTZ 1, QUARTZ 2, BLACK RAL 9005, MATTE BLACK, JANUARY 2, MATTE BLACK STR. OR ANY COLOUR



AXIAL VALVE KIT

Left-hand supply valve
 (thermostatic head facing right)
 right hand side) 1/2 x 1/2" or
Right-hand stop valve
 (thermostat head facing left) 1/2 x 1/2" or
Right angle return valve 1/2 x 1/2"
Colour: WHITE / ANTHRACITE, CHROME, QUARTZ 1, QUARTZ 2, BLACK RAL 9005, MATTE BLACK, JANUARY 2, MATTE BLACK STR. OR ANY COLOUR



VALVES



COMBINATION VALVE SET DUO 50 MM



Colour: WHITE / ANTHRACITE, CHROME, QUARTZ 1, QUARTZ 2, BLACK RAL 9005, MATTE BLACK, JANUARY 2, MATTE BLACK STR. OR ANY COLOUR

COMBINATION VALVE SET 50 MM



TYPE VK, ANGLED OR STRAIGHT IN ANY COLOUR

DUO MAX VALVE INCLUDED:
fittings for PEX 16 or copper pipes,
masking sleeves, rectangular rosette



Colour: WHITE / ANTHRACITE, CHROME, QUARTZ 1, QUARTZ 2, BLACK RAL 9005, MATTE BLACK, JANUARY 2, MATTE BLACK STR. OR ANY COLOUR

VALVE KIT ONE HOLE 50 MM



Colour: WHITE / ANTHRACITE, CHROME, BLACK RAL 9005, MATTE BLACK

THERMOSTATIC TEE



Valve Axial thermostatic tee 1/2" x M22
dedicated to connecting the heater
Angle return tee valve 1/2" x M22
Thermostatic head
Colour: WHITE / ANTHRACITE, CHROME, BLACK RAL 9005, MATTE BLACK

PEX OR COPPER CONNECTORS
DEDICATED FOR STRAIGHT,
ANGLED, AXIAL AND DUO VALVES



2 additional years
of warranty
when purchasing
valves

VALVES

MASKING SYSTEM
FOR VALVES WITH
PEX OR COPPER
CONNECTORS



Colour: WHITE/ANTHRACITE,
CHROME, JANUARY 2,
BLACK RAL 9005, MATTE
BLACK, MATTE BLACK STR.
OR ANY COLOUR

MASKING SYSTEM
FOR VALVES WITH-
OUT CONNECTORS



Colour: WHITE, CHROME,
MATTE BLACK,

ADDITIONAL CONNEC-
TION ELEMENTS



**TEE FOR THE
HEATER.**

WHITE COLOUR,
CHROME, JANUARY
2, MATTE BLACK STR.



SINGLE ROSETTE
round, oval
and rectangular)
FOR VALVES
IN ANY COLOUR



HEATERS

Heater GT

with built-in thermostat

Power:
300 W, 600 W, 900 W

Colour:
WHITE, CHROME, SATIN



Heater HQ

Power:
200 W, 300 W, 400 W,
500 W, 600 W, 800 W,
1000 W
Colour:
WHITE, CHROME, BLACK,
GRAPHITE STR., ANTHRACITE



HQ New heater with cable

Power:
200 W, 300 W, 400 W,
500 W, 600 W, 800 W,
1000 W

Colour:
WHITE, CHROME, BLACK,
GRAPHITE STR., ANTHRACITE



HEATERS



HQ New heater with a cover

Power:

200 W, 300 W, 400 W,
500 W, 600 W, 800 W,
1000 W

Colour:

WHITE, CHROME, BLACK,
GRAPHITE STR.,
ANTHRACITE



HQ New BT heater with cable



Power:

200 W, 300 W, 400 W,
500 W, 600 W, 800 W,
1000 W

Colour:

WHITE, CHROME, BLACK,
GRAPHITE STR.,
ANTHRACITE

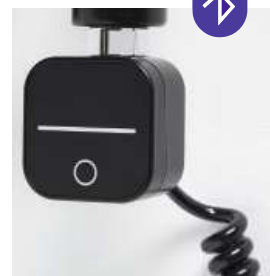

HQ BT New heater with a cover

Power:

200 W, 300 W, 400 W,
500 W, 600 W, 800 W,
1000 W

Colour:

WHITE, CHROME, BLACK,
GRAPHITE STR.,
ANTHRACITE



LUXRAD heater in a set with a tee MOUNTING KITS

Power:

300 W, 600 W, 900 W

Colour:

WHITE, CHROME,



MOUNTING KITS

MOUNTING KIT FOR THE BATHROOM RADIATOR

mounted between the tubes
(3-element)



MOUNTING KIT FOR THE BATHROOM RADIATOR

mounted on horizontal
tubes (3-piece)



MOUNTING KIT FOR THE BATHROOM RADIATOR

with mounting system on sleeves (4 elements)



FOR ROOM RADIATORS

it is necessary to enter the model of
the radiator in the order (4 elements)



2 additional years
of warranty
when purchasing
valves

HANGERS

T-point hanger plastic, white

Application: bathroom tubular radiators



T-point hanger plastic, chrome-plated

Application: bathroom tubular radiators



Round metal point hanger, square and triangular

Application: panel heaters and tubular bathroom heaters

Colour: white / anthracite or any colour



HANGER H straight RELING

lengths: 480 mm, 570 mm, 670 mm
colour: white / anthracite or any colour



HANGER H bent RELING

lengths: 480 mm, 570 mm, 670 mm
lengths: white / anthracite or any colour



SHELF for bathroom radiator

lengths: 480 mm, 570 mm, 670 mm
colour: white / anthracite or any colour

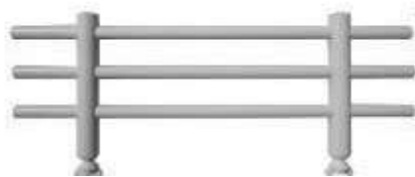

HANGER for panel radiator

lengths: 510 mm, 710 mm, 910 mm
colour: white / anthracite



HANGER Z left and right

lengths: 295 mm, 445 mm, 518 mm, 595 mm, 745 mm
colour: white / anthracite or any colour



Extend the warranty for 2 more years by purchasing Luxrad valve

CHOOSE A HANGER FOR THE RADIATOR



ROOM
RADIATORS

BATHROOM
RADIATORS

CHROME
RADIATORS

STAINLESS STEEL
RADIATORS

POWER,
ACCESSORIES

VALVES,
CONNECTIONS

HANGERS		WPTBL	WPTCH	WPTBL/ANT	WPXBL/ANT	WPOBL/ANT	WHP480BL/ANT	WHP570BL/ANT	WHP670BL/ANT	WHG480BL/ANT	WHG570BL/ANT	WHG670BL/ANT	PGL480BL/ANT	PGL570BL/ANT	PGL670BL/ANT	WGP510BL/ANT	WGP710BL/ANT	WGP910BL/ANT	WZL295BL/ANT	WZL445BL/ANT	WZL518BL/ANT	WZL595BL/ANT	WZL745BL/ANT	WZP295BL/ANT	WZP445BL/ANT	WZP518BL/ANT	WZP595BL/ANT	WZP745BL/ANT
T-POINT HANGER made of plastic white																												
T-POINT HANGER made of plastic chrome plated																												
METAL TRIANGULAR POINT HANGER white / anthracite																												
SQUARE POINT METAL HANGER white / anthracite																												
METAL ROUND POINT HANGER white / anthracite																												
HANGER H straight RELING length 480 mm white / anthracite																												
HANGER H straight RELING length 570 mm white / anthracite																												
HANGER H straight RELING length 670 mm white / anthracite																												
HANGER H bent RELING length 480 mm white / anthracite																												
HANGER H bent RELING length 570 mm white / anthracite																												
HANGER H bent RELING length 670 mm white / anthracite																												
SHELF for a bathroom radiator, length 480 mm white / anthracite																												
SHELF for a bathroom radiator, length 570 mm white / anthracite																												
SHELF for a bathroom radiator, length 670 mm white / anthracite																												
HANGER for a steel panel radiator, 510 mm long white / anthracite																												
HANGER for a steel panel radiator, length 710 mm white / anthracite																												
HANGER for a steel panel radiator, length 910 mm white / anthracite																												
HANGER From the left, length 295 mm white / anthracite																												
HANGER From the left, length 445 mm white / anthracite																												
HANGER From the left, length 518 mm white / anthracite																												
HANGER From the left, length 595 mm white / anthracite																												
HANGER From the left, length 745 mm white / anthracite																												
HANGER Z right, length 295 mm white / anthracite																												
HANGER Z right, length 445 mm white / anthracite																												
HANGER Z right, length 518 mm white / anthracite																												
HANGER Z right, length 595 mm white / anthracite																												
HANGER Z right, length 745 mm white / anthracite																												

years by purchasing Luxrad valve

TYPES OF CONNECTIONS FOR RADIATORS



Cross-flow power supplying

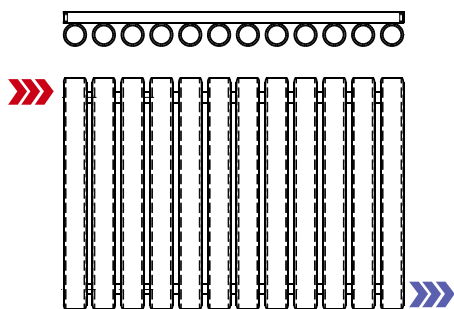

Cross-flow power supplying

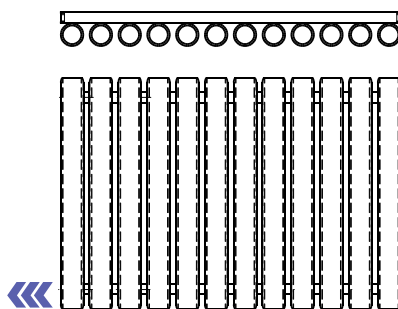

Side left power supplying

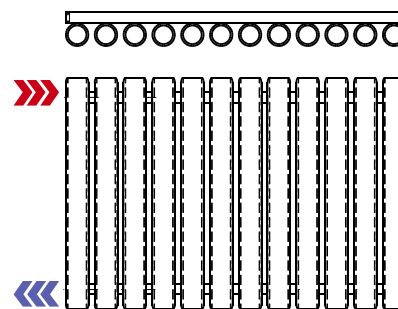

Side right power supplying

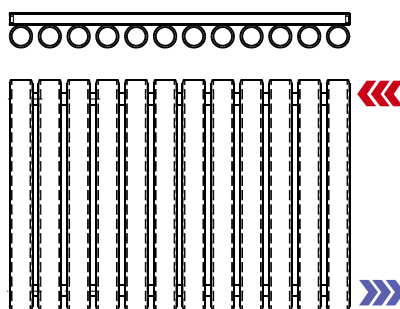

Power supplying by bottom collector

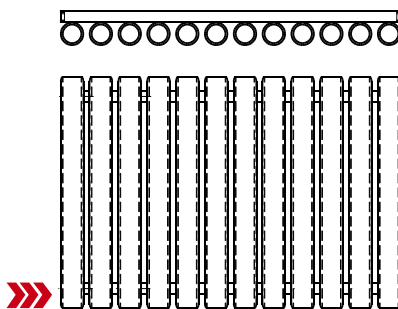

Power supplying by bottom collector

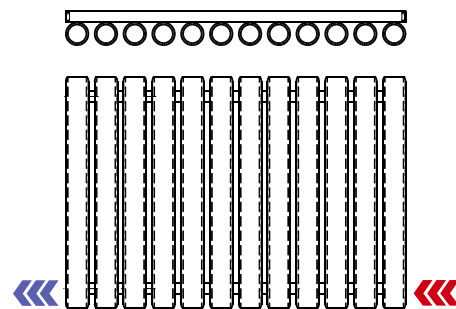

Optional bottom connections

Bottom left power supplying 50 mm

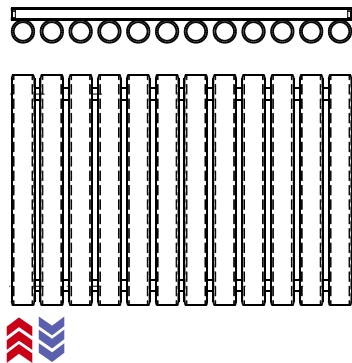

Bottom central power supplying 50

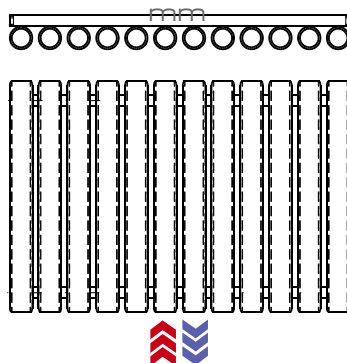

Bottom right power supplying 50 mm

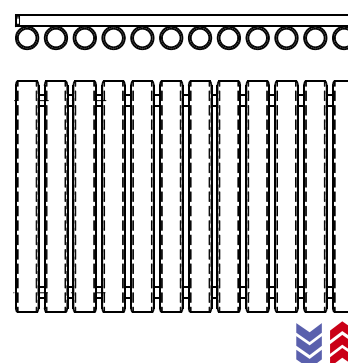

ZASILANIE
CIEPŁA WODA



POWRÓT
ZIMNEJ WODY

TYPES OF CONNECTIONS FOR BATHROOM RADIATORS



Bottom power supplying

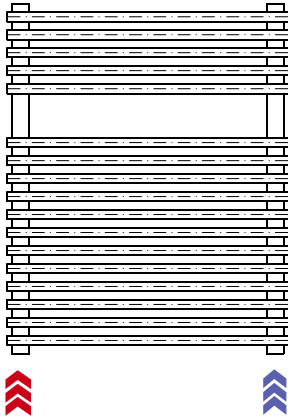

Bottom power supplying

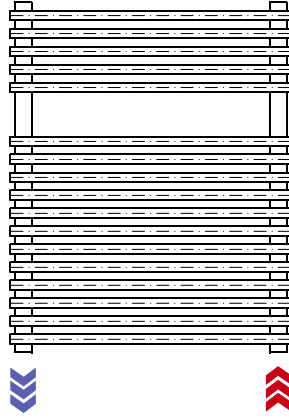

Cross-flow power supplying

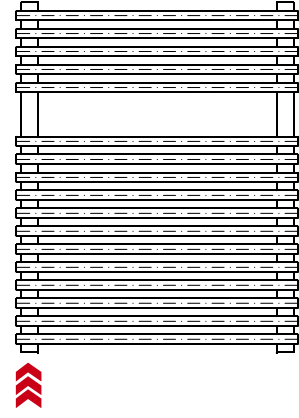

OPTIONAL

Power supplying with collector

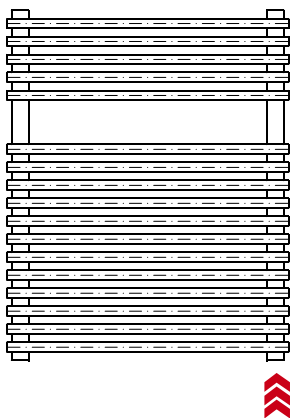

Side left power supplying

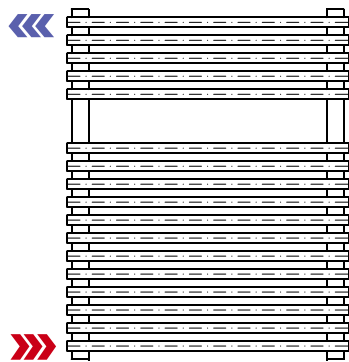

Side right power supplying

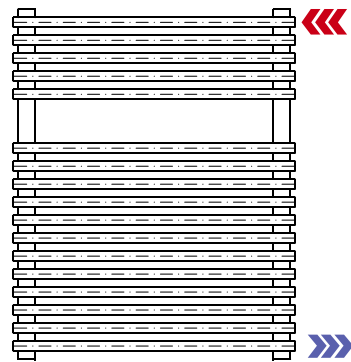

Bottom left power supplying 50 mm

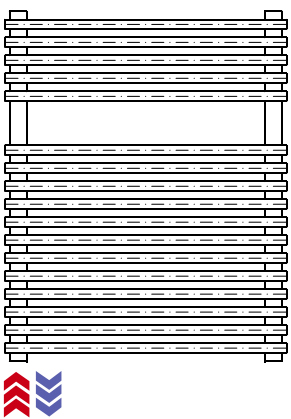

Bottom central power supplying 50 mm

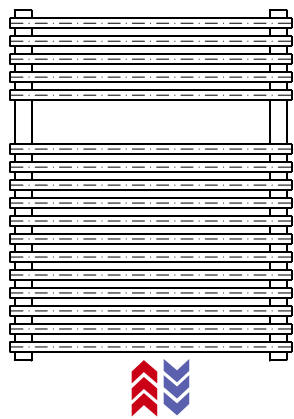

Bottom right power supplying 50 mm

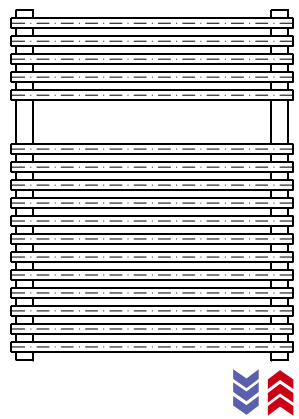

HOT WATER SUPPLY



COLD WATER RETURN

6+2
WARRANTY

2 additional years of warranty when purchasing valves

info@luxrad.com

185

SPECIAL COLOURS



1 February



2 January



4 February



4 January



8 February



9 January



Azurite 2



Azurite 4

RAL 9005
TextureManganese
B2350

Antic copper



Oxide 1



Oxide 2



Quarz 1



Quarz 2



Antic silver



Dark silver

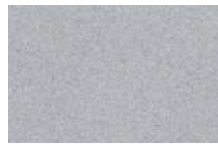

Light silver



Noble Sand



Antic gold

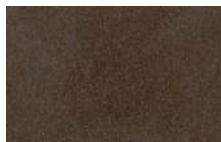

Anodic Brown

RAL 3002
Structure

Bariton 2

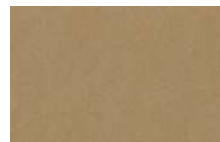

Gold

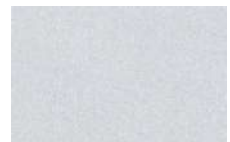

Anodic Natura



Bronze BG 600



5 January



Silber D1

RAL 9010
SatineRAL 9016
Fine

Black Matte



6 February



Energy 3



Eden Garden



Navy Blue

SAMPLE COLOURS



Whole range of RAL colours available

RAL 1001	RAL 1013	RAL 1015	RAL 1018	RAL 1019
RAL 1037	RAL 2009	RAL 3003	RAL 3020	RAL 4005
RAL 5005	RAL 5007	RAL 6027	RAL 6029	RAL 7003
RAL 7005	RAL 7016 Standard colour	RAL 7026	RAL 7035	RAL 7036
RAL 7043	RAL 7046	RAL 7047	RAL 8002	RAL 8012
RAL 8016	RAL 8017	RAL 9001	RAL 9003 Standard colour	RAL 9005
RAL 9006	RAL 9007	RAL 9010	RAL 9016	RAL 9017

Exemplary colours. Colours of radiators can vary.

ROOM
RADIATORS

BATHROOM
RADIATORS

CHROME
RADIATORS

STAINLESS STEEL
RADIATORS

POWER,
ACCESSORIES

CONNECTIONS

COLOURS

6+2
WARRANTY

2 additional years
of warranty
when purchasing
valves

info@luxrad.com

187



Luxrad Polska Mazur i Wspólnicy Sp.j.

ul. Parkowa 1, 05-800 Pruszków
tel. 22 863 22 40, fax 22 863 35 15

info@luxrad.com
www.luxrad.com